

BUSH HOG®

RZ 60 Rotary Cutter Operator's Manual



BUSH HOG®
Performance You Can Count On™

OPERATION ● MAINTENANCE

CONGRATULATIONS!

You have invested in the best implement of its type on the market today.

The care you give your Bush Hog implement will greatly determine your satisfaction with its performance and its service life. We urge a careful study of this manual to provide you with a thorough understanding of your new implement before operating, as well as suggestions for operation and maintenance.

If your manual should become lost or destroyed, Bush Hog will be glad to provide you with a new copy. Order from Bush Hog, P. O. Box 1039, Selma, Alabama 36702-1039. Most of our manuals can also be downloaded from our website at www.bushhog.com.

As an authorized Bush Hog dealer, we stock genuine Bush Hog parts which are manufactured with the same precision and skill as our original equipment. Our trained service personnel are well informed on methods required to service Bush Hog equipment, and are ready and able to help you.

Should you require additional information or assistance, please contact us.

YOUR AUTHORIZED
BUSH HOG DEALER

BECAUSE BUSH HOG MAINTAINS AN ONGOING PROGRAM OF PRODUCT IMPROVEMENT, WE RESERVE THE RIGHT TO MAKE IMPROVEMENTS IN DESIGN OR CHANGES IN SPECIFICATIONS WITHOUT INCURRING ANY OBLIGATION TO INSTALL THEM ON UNITS PREVIOUSLY SOLD.

BECAUSE OF THE POSSIBILITY THAT SOME PHOTOGRAPHS IN THIS MANUAL WERE TAKEN OF PROTOTYPE MODELS, PRODUCTION MODELS MAY VARY IN SOME DETAIL. IN ADDITION, SOME PHOTOGRAPHS MAY SHOW SHIELDS REMOVED FOR PURPOSES OF CLARITY. **NEVER OPERATE** THIS IMPLEMENT WITHOUT ALL SHIELDS IN PLACE.

RAZORBACK

RAZORBACK ROTARY CUTTER TABLE OF CONTENTS

SECTION/PARA	PAGE	SECTION/PARA	PAGE
Warranty	3	IV.MAINTENANCE	10
Dealer Preparation Check List	4	4-1 Maintenance Check List	10
Safety Precautions.....	5	4-2 Lubrication	10
I. INTRODUCTION & DESCRIPTION	6	4-3 Blade Replacement	11
1-1 Introduction	6	4-4 Shear Bolt Replacement.....	11
1-2 Description.....	6	4-5 Blade Holder & Gearbox Removal	11
II. PREPARATION FOR USE	7	4-6 Blade Holder & Gearbox Installation..	11
III.OPERATING INSTRUCTIONS.....	8	4-7 Troubleshooting	12
3-1 General Safety.....	8	V. ASSEMBLY	13
3-2 Adjusting for Work	8	5-1 Base Unit Assembly	13
3-3 Operation	9	5-2 Front & Rear Shielding Installation	13
		Safety Decals	14
		Torque Specifications.....	15

RETAIL CUSTOMER'S RESPONSIBILITY UNDER THE BUSH HOG WARRANTY

It is the Retail Customer and/or Operator's responsibility to read the Operator's Manual, to operate, lubricate, maintain and store the product in accordance with all instructions and safety procedures. Failure of the operator to read the Operator's Manual is a misuse of this equipment.

It is the Retail Customer and/or Operator's responsibility to inspect the product and to have any part(s) repaired or replaced when continued operation would cause damage or excessive wear to other parts or cause a safety hazard.

It is the Retail Customer's responsibility to deliver the product to the authorized Bush Hog Dealer, from whom he purchased it, for service or replacement of defective parts which are covered by warranty. Repairs to be submitted for warranty consideration must be made within forty-five (45) days of failure.

It is the Retail Customer's responsibility for any cost incurred by the Dealer for traveling to or hauling of the product for the purpose of performing a warranty obligation or inspection.



LIMITED WARRANTY



Bush Hog warrants to the original purchaser of any new Bush Hog equipment, purchased from an authorized Bush Hog dealer, that the equipment be free from defects in material and workmanship for a period of one (1) year for non-commercial, state, and municipalities' use and ninety (90) days for commercial use from date of retail sale. The obligation of Bush Hog to the purchaser under this warranty is limited to the repair or replacement of defective parts.

Replacement or repair parts installed in the equipment covered by this limited warranty are warranted for ninety (90) days from the date of purchase of such part or to the expiration of the applicable new equipment warranty period, whichever occurs later. Warranted parts shall be provided at no cost to the user at an authorized Bush Hog dealer during regular working hours. Bush Hog reserves the right to inspect any equipment or parts which are claimed to have been defective in material or workmanship.

DISCLAIMER OF IMPLIED WARRANTIES & CONSEQUENTIAL DAMAGES

Bush Hog's obligation under this limited warranty, to the extent allowed by law, is in lieu of all warranties, implied or expressed, **INCLUDING IMPLIED WARRANTIES OF MERCHANTABILITY AND FITNESS FOR A PARTICULAR PURPOSE** and any liability for incidental and consequential damages with respect to the sale or use of the items warranted. Such incidental and consequential damages shall include but not be limited to: transportation charges other than normal freight charges; cost of installation other than cost approved by Bush Hog; duty; taxes; charges for normal service or adjustment; loss of crops or any other loss of income; rental of substitute equipment, expenses due to loss, damage, detention or delay in the delivery of equipment or parts resulting from acts beyond the control of Bush Hog.

THIS LIMITED WARRANTY SHALL NOT APPLY:

1. To vendor items which carry their own warranties, such as engines, tires, and tubes.
2. If the unit has been subjected to misapplication, abuse, misuse, negligence, fire or other accident.
3. If parts not made or supplied by Bush Hog have been used in connection with the unit, if, in the sole judgement of Bush Hog such use affects its performance, stability or reliability.
4. If the unit has been altered or repaired outside of an authorized Bush Hog dealership in a manner which, in the sole judgement of Bush Hog, affects its performance, stability or reliability.
5. To normal maintenance service and normal replacement items such as gearbox lubricant, hydraulic fluid, worn blades, or to normal deterioration of such things as belts and exterior finish due to use or exposure.
6. To expendable or wear items such as teeth, chains, sprockets, belts, springs and any other items that in the company's sole judgement is a wear item.

NO EMPLOYEE OR REPRESENTATIVE OF BUSH HOG IS AUTHORIZED TO CHANGE THIS LIMITED WARRANTY IN ANY WAY OR GRANT ANY OTHER WARRANTY UNLESS SUCH CHANGE IS MADE IN WRITING AND SIGNED BY BUSH HOG'S SERVICE MANAGER, POST OFFICE BOX 1039, SELMA, ALABAMA 36702-1039.



Record the model number, serial number and date purchased. This information will be helpful to your dealer if parts or service are required.

MODEL NUMBER _____

SERIAL NUMBER _____

MAKE CERTAIN THE WARRANTY REGISTRATION CARD HAS BEEN FILED WITH BUSH HOG/SELMA, ALABAMA.

DATE OF RETAIL SALE _____

DEALER PREPARATION CHECK LIST

RAZORBACK ROTARY CUTTERS

BEFORE DELIVERING MACHINE — The following check list should be completed.
Use the Operator's Manual as a guide.

- 1. Assembled completed.
- 2. Gearbox filled with oil.
- 3. All fittings lubricated.
- 4. All shields in place and in good condition.
- 5. All fasteners torqued to specifications given in Torque Chart.
- 6. All decals in place and readable. (See decal page.)
- 7. Overall condition good (i.e. paint, welds)
- 8. Operators manual has been delivered to owner and he has been instructed on the safe and proper use of the cutter.
- 9. Purchaser or dealer elects to delete deflectors. (front belting, rear bands, front and rear chains)

Explanation: _____

WARNING

For Non-Agricultural use, OSHA, ASAE, SAE and ANSI standards require the use of Chain Guards or other protective guards at all times. Bush Hog strongly recommends the use of such guards for Agricultural uses as well, to reduce the risk of property damage, serious bodily injury or even death from objects thrown out by or from contact with the cutting blades.

Dealer's
Signature _____

Purchaser's
Signature _____

THIS CHECKLIST TO REMAIN IN OWNER'S MANUAL
It is the responsibility of the dealer to complete the procedures listed
above before delivery of this implement to the customer.

IMPORTANT SAFETY PRECAUTIONS

This symbol is used to call attention to safety precautions that should be followed by the operator to avoid accidents. When you see this symbol, carefully read the message that follows and heed its advice. Failure to comply with safety precautions could result in serious bodily injury.



In addition to the design and configuration of equipment, hazard control and accident prevention are dependent upon the awareness, concern, prudence and proper training of personnel in the operation, transport, maintenance and storage of equipment. Lack of attention to safety can result in accident, personal injury, reduction of efficiency and worst of all—loss of life. Watch for safety hazards and correct deficiencies promptly. Use the following safety precautions as a general guide to safe operations when using this machine. Additional safety precautions are used throughout this manual for specific operating and maintenance procedures. Read this manual and review the safety precautions often until you know the limitations.

1. Read the Operator's Manual. Failure to read the Operator's Manual is considered a misuse of this equipment.
2. Become familiar with all the machine's controls and all the caution, warning and danger decals affixed to the machine before attempting to start or operate.
3. Before starting or operating the machine, make a walk around inspection and check for obvious defects such as loose mounting bolts and damaged components. Correct any deficiency before starting.
4. Do not allow children to operate the cutter. Do not allow adults to operate it without proper instruction.
5. Do not carry passengers.
6. Keep the area of operation clear of all persons, particularly small children and pets. The operator should cease mowing whenever anyone comes within the operating area.
7. Clear the work area of objects which might be picked up and thrown.
8. Use a piece of cardboard or wood rather than hands to search for hydraulic leaks. Escaping hydraulic oil under pressure can penetrate skin. If fluid is injected into the skin, it must be surgically removed within a few hours by a doctor familiar with this form of injury or gangrene may result.
9. Do not operate without all guards and shields in place and in good condition.
10. Lower implement to ground, stop tractor engine, apply parking brake, and allow blades to completely stop before leaving the tractor.
11. Keep hands and feet away from blades.
12. This cutter is not to be operated along highways or in any area where people may be present unless all sides of the unit are enclosed by permanent bands, safety chains or other factory approved safety shields that are in good repair.
13. Wear personal protective equipment such as, but not limited to, protection for eyes, ears, feet, hands and head when operating or repairing the equipment. Do not wear loose clothing or jewelry that may catch on equipment moving parts.
14. When performing adjustments or maintenance on the cutter, first lower it to the ground or block it securely at a workable height.
15. Never stand between tractor and cutter while tractor is being backed to the cutter hitch.
16. Reduce speed when transporting cutter to avoid bouncing and momentary loss of steering.
17. Use tractor flashing warning lights, day or night, when transporting cutter on road or highways unless prohibited by law.
18. In the event that someone other than yourself will operate this equipment we firmly suggest that all SAFETY references be discussed prior to operation.
19. It is recommended that tractor be equipped with Rollover Protective System (ROPS) and seat belt be used in all mowing operations.

SECTION I INTRODUCTION AND DESCRIPTION

1-1 INTRODUCTION

We are pleased to have you as a Bush Hog customer. Your Razorback Rotary Cutter has been carefully designed to give maximum service with minimum down time. This manual is provided to give you the necessary operating and maintenance instructions for keeping your rotary cutter in top operating condition. Please read this manual thoroughly. Understand what each control is for and how to use it. Observe all safety precautions decaled on the machine and noted throughout the manual for safe operation of implement. If any assistance or additional information is needed, contact your authorized Bush Hog dealer.

NOTE

All references made in this manual to right, left, front, rear, top, and bottom are as viewed as facing the direction of forward travel with implement properly attached to tractor.

1-2 DESCRIPTION

The Razorback Rotary Cutters (Figure 1-1) are light duty cutters intended for cutting grass and small brush up to 1" diameter. Each cutter has two 3/8 x 3" blades that are free-swinging to reduce the shock of impact when a stationary object is hit. A 1/2 x 3" Grade 2 shear bolt protects the gearbox and driveline from damage. The 35 HP gearbox is designed for 540 RPM input speed giving the blades a 12,468 ft./min. tip speed. Front and rear discharge shields are included as standard equipment. (Note: Dealer or purchaser may elect to delete at their option) Total weight of the machine is 450 lbs.

Figure 1-1 Major Components

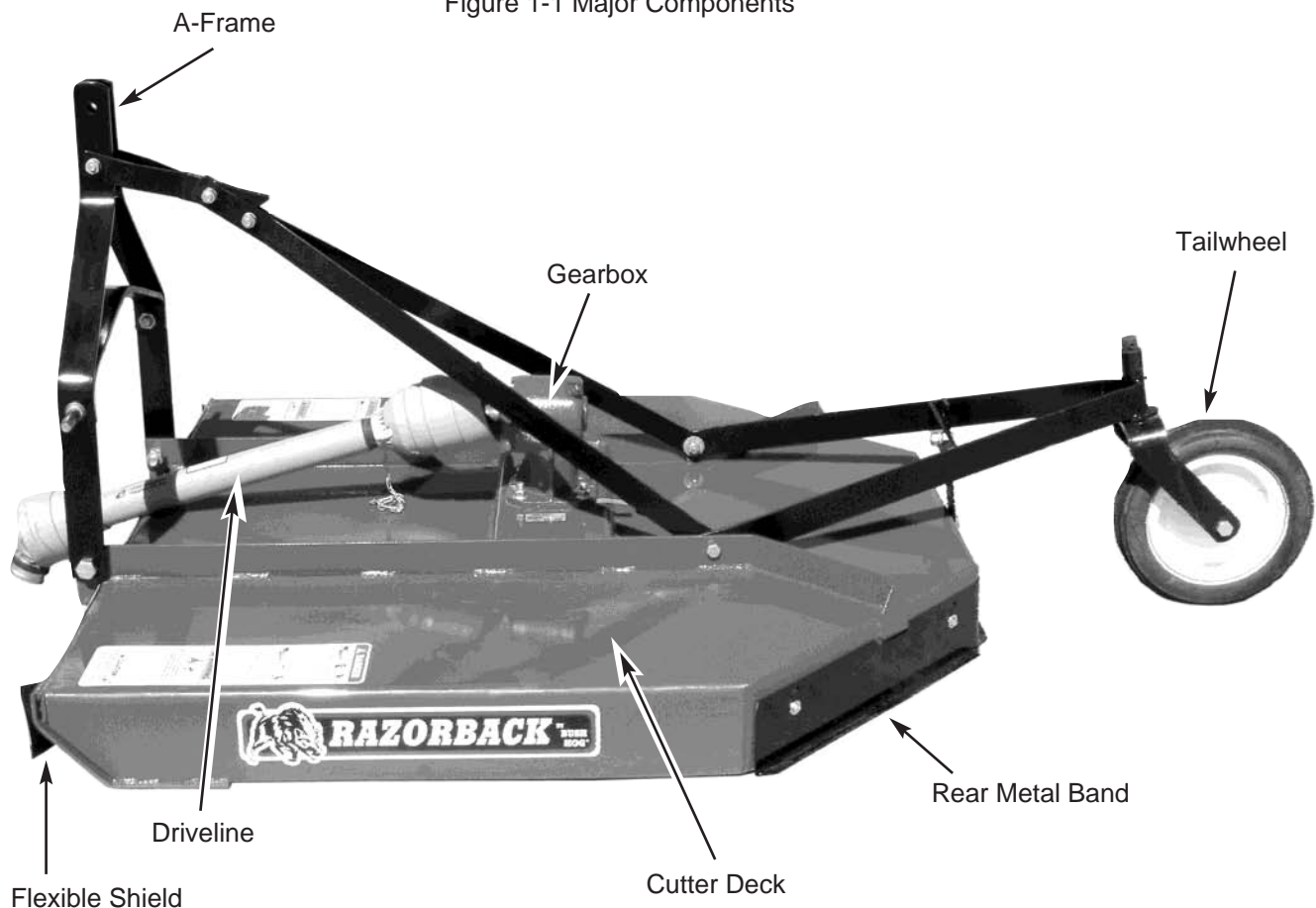

SECTION II PREPARATION FOR USE

NOTE

Tractor should have 25 -35 PTO horsepower. It is recommended that front end ballast, wheel weights and/or fluid in tires be used to increase stability.

A. Attach cutter to Category I 3-point hitch per tractor operator's manual. Do not connect driveline at this time.

NOTE

Due to the many variations in tractor/implement hitch points and corresponding differences in distances between tractor PTO shafts and implement input shafts, drivelines may need to be shortened as described in the following steps:

B. Raise and lower cutter to determine position with shortest distance between the tractor PTO shaft and gearbox input shaft. Shut down tractor leaving cutter in position of shortest distance. **Securely block cutter in position.** (Figure 2-1)

C. Pull driveline apart. Attach outer (female) section to tractor PTO shaft. Pull on driveline section to be sure that yoke locks into place.

D. Hold driveline sections parallel to each other to determine if too long. Each section should end approximately 3 inches (76mm) short of reaching universal joint shield on opposite section. If too long, measure 3 inches (76mm) back from universal joint shield and mark on opposite section. (Figure 2-1). Do this for both sections.

Figure 2-1



E. Raise and lower cutter to determine position with greatest distance between PTO shaft and gearbox input shaft. Shut down tractor leaving cutter in position of greatest distance. **Securely block cutter in position.** (Figure 2-1)

F. Hold driveline sections parallel to each other and check for minimum 5 inches (15cm) overlap. (Figure 2-2) If driveline has been marked for cutting, overlap will be the distance between two marks. If driveline has less than minimum overlap, do not use. Contact authorized Bush Hog dealer.

Figure 2-2

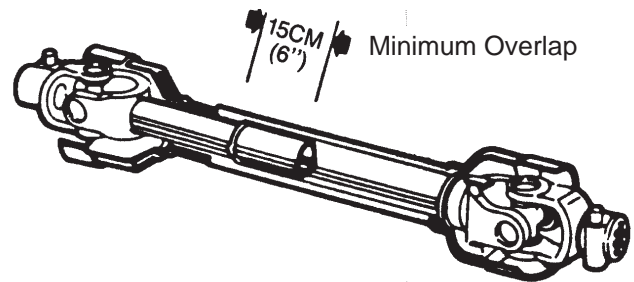

NOTE

If driveline is the correct length, omit the following steps "G" through "J" and proceed to step "K".

G. Clamp driveline in a well padded vice to prevent damage to the shield. Cut off shield where marked. (Figure 2-3)

Figure 2-3



H. Using cut of section of shield as a guide, cut shaft the same amount. (Figure 2-4)

I. Repeat steps "G" and "H" to other driveline section.

J. Deburr ends of driveline sections and clean away all chips and filings. (Figure 2-5)

K. Apply multi-purpose grease to inside of outer (female) driveline section. Assemble driveline and install on tractor and cutter. Pull on each driveline

Figure 2-4



section to be sure yokes lock into place. Make certain driveline shielding is in place and in good condition.

L. Adjust lower lift arm(s) to level cutter right to left. Refer to tractor operator's manual for instructions.

M. Connect and/or adjust stabilizer bars, sway blocks, sway chains or equivalent to prevent side sway. Refer to tractor operator's manual.

Figure 2-5



SECTION III OPERATING INSTRUCTIONS

3-1 GENERAL SAFETY

Only qualified people should operate this machine. Operator should wear hard hat, safety glasses and safety shoes. It is recommended that tractor be equipped with Rollover Protective Systems (ROPS) and a seat belt be used. Before beginning operation, clear work area of objects that may be picked up and thrown. Check for ditches, stumps, holes or other obstacles that could upset tractor or damage cutter. Always turn off tractor engine, set parking brake, and allow cutter blades to come to a complete stop before dismounting tractor.

3-2 ADJUSTING FOR WORK

The cutter should be operated at the highest position which will give desired cutting results. This will help prevent the blades from striking the ground, reducing blade wear and undue strain on the machine. For best results under heavier cutting conditions, always tilt the cutter approximately 2 inches (51mm) lower in the front. This tilt decreases horsepower requirements and increases potential ground speed. When fine shredding is desired, adjust cutter deck level or slightly lower in the rear. This will keep the foliage under cutter until thoroughly shredded. More power is required for shredding.

The cutting height is adjustable from 2 -12 inches. To adjust, proceed as follows:

A. Raise cutter off ground using tractor 3-point lift. Turn off tractor engine.

B. SECURELY BLOCK CUTTER INTO POSITION.

WARNING

DO NOT GET UNDER CUTTER UNLESS IT IS SECURELY BLOCKED IN POSITION. ACCIDENTAL FALL COULD CAUSE SERIOUS INJURY OR DEATH.

C. Remove bolt securing tailwheel frame to adjusting strap. (Figure 3-1)

D. Adjust tailwheel to desired position. Secure with bolt, lockwasher and nut.

E. Lower cutter to work position.

F. Adjust tractor 3-point hitch top link so that there will be a small amount of slack in the yoke linkage to allow deck to float during operation. (Figure 3-2)

Figure 3-1 Cutting Height Adjustment

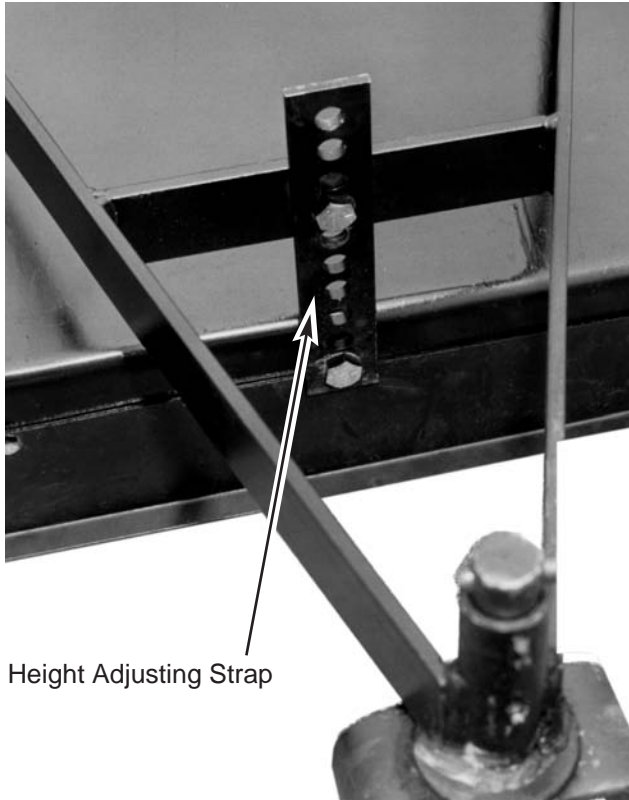

Height Adjusting Strap

Figure 3-2

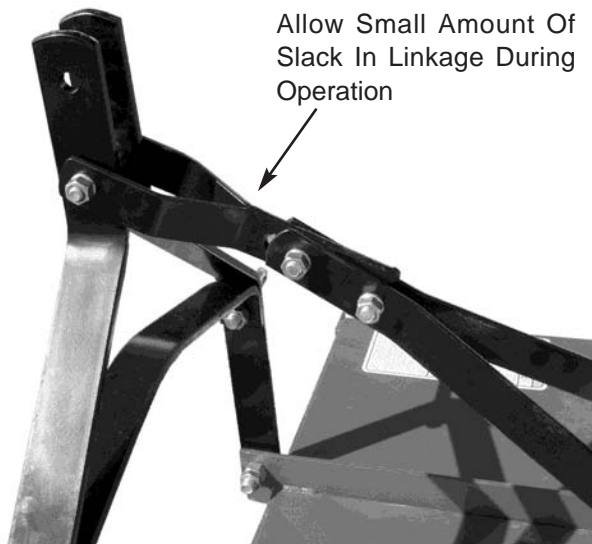

3-3 OPERATION

- A. Perform BEFORE EACH USE maintenance listed in paragraph 4-1.
- B. Start tractor per tractor operator's manual.
- C. Raise/lower 3-point hitch to place cutter in working position,
- D. Look to be sure no one is near cutter. WITH TRACTOR AT IDLE SPEED, SLOWLY ENGAGE PTO DRIVE. This will prolong life of driveline components.

⚠ DANGER

STAY CLEAR OF ROTATING DRIVELINE DO NOT OPERATE WITHOUT DRIVELINE SHIELDS IN PLACE AND IN GOOD CONDITION. FAILURE TO HEED THESE WARNINGS MAY RESULT IN PERSONAL INJURY OR DEATH.

⚠ DANGER

ROTATING CUTTER BLADES. STAND CLEAR UNTIL ALL MOTION HAS STOPPED. TO AVOID AN ACCIDENTAL FALL FROM TRACTOR AND POSSIBLE INJURY BY MOWER, IT IS RECOMMENDED THAT TRACTOR BE EQUIPPED WITH ROLLOVER PROTECTIVE SYSTEM (ROPS) AND A SEAT BELT BE USED BY THE OPERATOR FOR ALL MOWING OPERATIONS.

E. Place tractor in gear and proceed forward. Advance the throttle to 540 PTO RPM. Tractor forward speed should be controlled by gear selection, not engine speed. For maximum cutting efficiency, forward speed should allow cutter to maintain a constant maximum blade speed. If cutter stalls or tractor engine bogs, disengage PTO. Before re-engaging PTO, position cutter in a cut area and reduce tractor throttle to idle. If cutter continuously stalls, select lower tractor gear and/or increase cutting height.

Blade rotation is counterclockwise causing cut material to discharge to the left side of cutter forming a windrow. To shred and dissipate this windrow, tractor should be driven in a counterclockwise direction throwing material to the uncut area. The windrowed material will be recut on each new pass. Tractor tire tracks are cut more efficiently when tractor is traveling in a clockwise direction especially when cutting height is high. Counterclockwise tractor travel requires more horsepower. Larger brush should be cut in the center of cutter. Always cut up and down the face of slopes, never across.

⚠ WARNING

ALL ROTARY CUTTERS CAN DISCHARGE OBJECTS AT HIGH SPEEDS WHICH COULD RESULT IN SERIOUS INJURY TO BYSTANDERS OR PASSERS-BY.

THEREFORE, THIS CUTTER IS NOT TO BE OPERATED ALONG HIGHWAYS OR IN ANY AREA WHERE PEOPLE MAY BE PRESENT UNLESS ALL SIDES OF THE UNIT ARE ENCLOSED BY PERMANENT BANDS THAT ARE IN GOOD REPAIR.

SECTION IV MAINTENANCE

4-1 MAINTENANCE CHECK LIST

Perform scheduled maintenance as outlined below. Lower machine to ground, turn off tractor and set parking brake before doing maintenance inspections or work. All bolts should be torqued as recommended in the Torque Specifications unless otherwise indicated.

WARNING

DO NOT GET UNDER CUTTER UNLESS IT IS SECURELY BLOCKED IN POSITION. ACCIDENTAL FALL COULD CAUSE SERIOUS INJURY OR DEATH.

BEFORE EACH USE

1. Check tractor air pressure. Refer to tractor operator's manual.
2. Check blades and spindles to be sure that no foreign objects such as wire or steel strapping bands are wrapped around them.
3. Check blade bolts for tightness. Tighten to 420 ft./lbs. (569 Nm)
4. Inspect blades for wear. Replace if necessary per paragraph 4-3. Always replace both blades with blades equal in weight. Use only genuine Bush Hog replacement blades.
5. Make certain bands are in good repair.
6. Make certain driveline shields are in place and in good repair.
7. Inspect wheel for wear, damage or foreign objects. Repair or replace if necessary.
8. Perform BEFORE EACH USE lubrication per paragraph 4-2.
9. During operation, listen for abnormal sounds which might indicate loose parts, damaged bearings, or other damage. Locate and repair or contact your dealer.

Figure 4-1 Lubrication

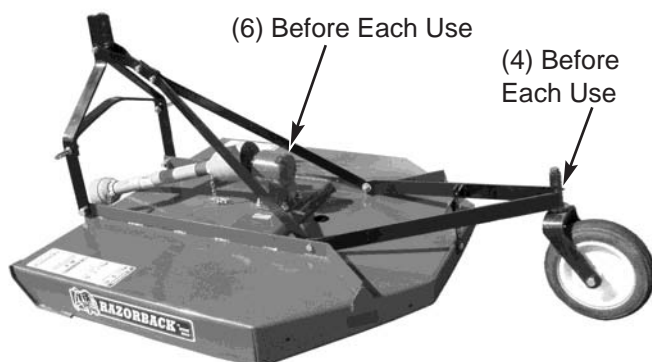

AFTER EACH USE

1. Clean all debris from machine especially underside of deck. When cleaning underside of deck, **SECURELY BLOCK MACHINE INTO POSITION.** (Figure 3-1)

4-2 LUBRICATION (Figure 4-1, & 4-2)

NOTE

The multi-purpose grease referenced in this section is an NLGI Grade 2 type grease.

BEFORE EACH USE

1. Driveline Universal Joints - Apply multi-purpose grease with grease gun.
2. Driveline Guard - Apply 2-3 shots of multi-purpose grease with grease gun to plastic fitting.
3. Driveline - Disconnect PTO driveline, pull two sections apart, and apply thin coat of multi-purpose grease to inside of outer female section. Re-assemble sections and install. Pull each section to be sure driveline and shields are securely connected. Make certain PTO shielding is in good condition.
4. Wheel Pivot Tubes - Apply multi-purpose grease with grease gun.
5. Yoke - Apply multi-purpose grease to grease fitting on shear bolt yoke. **IMPORTANT: THIS FITTING MUST BE GREASED REGULARLY TO PREVENT YOKE FROM SEIZING TO INPUT SHAFT RENDERING SHEAR BOLT USELESS.**
6. Gearbox - Check oil level by removing oil level check plug on rear of gearbox. Add EP80W-90 gear oil if necessary to bring oil to check plug hole. Capacity is 18 oz.

Figure 4-2 (2) Before Each Use **EG DRIVELINE**

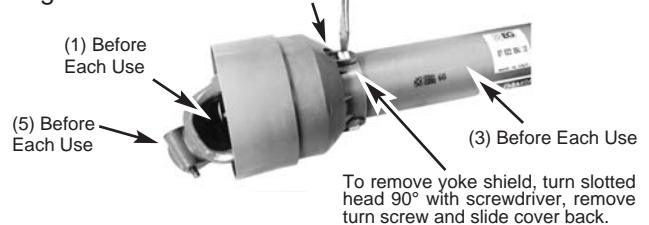

BINACCHI DRIVELINE (2) Before Each Use

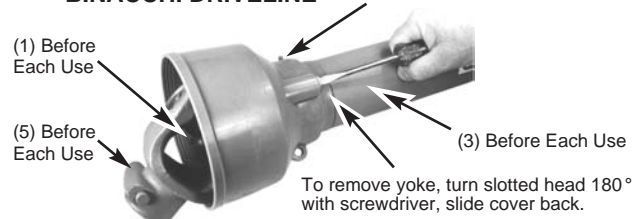

4-3 BLADE REPLACEMENT

It is not necessary to remove the complete blade holder assembly to replace the blades. Blade bolts are accessible through a hole in the top of the cutter deck. To maintain proper balance always replace both blades on a blade holder using two blades having the same weight. Use only genuine Bush Hog replacement blades. (Figure 4-3)

Figure 4-3 Shear Bolt Blade Bolt

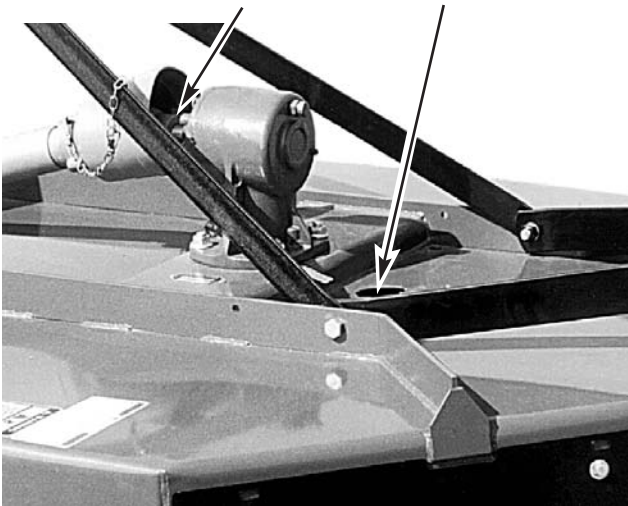

A. Raise cutter and **SECURELY BLOCK IN POSITION.**

B. Remove nuts from blade bolts using a 1-5/16" socket. Remove blades, bolts and washers.

C. Inspect blade bolt shoulder for wear. Replace if necessary.

D. Assemble new blades to blade holder using blade bolts, nuts and lockwashers. Tighten nuts to 420 ft./lbs. (569 Nm) It may be necessary to hold blade bolt with pipe wrench. Strike head of bolt several times with a hammer, then retighten.

E. Check to be sure blades swing 360° freely. If blades will not swing freely, remove, locate problem, and repair. Operating cutter when blades will not swing freely will cause excessive vibration, damaging implement.

⚠ WARNING

DO NOT GET UNDER CUTTER UNLESS IT IS SECURELY BLOCKED IN POSITION. ACCIDENTAL FALL COULD CAUSE SERIOUS INJURY OR DEATH.

4-4 SHEAR BOLT REPLACEMENT

A. Refer to Figure 4 and slide yoke shield back.

B. Remove sheared bolt from input shaft using hammer and punch.

C. Inspect retaining clip to make certain it is securely installed in groove.

⚠ WARNING

FAILURE TO USE CORRECT SIZE SHEAR BOLT MAY CAUSE PERSONAL INJURY OR DEATH.

⚠ WARNING

FAILURE TO INSTALL RETAINING CLIP WILL ALLOW DRIVELINE TO SWING FREELY IF BOLT IS SHEARED CAUSING POSSIBLE INJURY OR DEATH.

D. Install new 1/2 x 3" Grade 2 shear bolt and locknut. Refer to torque chart on page 15.

E. Lock yoke shield securely into place.

4-5 BLADE HOLDER & GEARBOX REMOVAL

A. Raise cutter using tractor 3-point lift. Turn off tractor engine.

B. **BLOCK CUTTER SECURELY INTO POSITION.**

⚠ WARNING

DO NOT GET UNDER CUTTER UNLESS IT IS SECURELY BLOCKED IN POSITION. ACCIDENTAL FALL COULD CAUSE SERIOUS INJURY OR DEATH.

C. Remove cotter pin and blade holder retaining nut. Wear heavy work gloves to protect hands from sharp edges.

D. Grasp blade holder and pull off shaft. If necessary, align blade bar with access hole in top of deck and drive off with hammer and pipe. Care should be taken not to damage threads on blade bolt.

E. Press all three tabs and slide yoke shield back. (Figure 4-2)

F. Remove shear bolt and retaining clip. Slide yoke off gearbox input shaft. (Figure 4-3)

G. Remove nuts securing gearbox to deck. Remove gearbox.

4-6 BLADE HOLDER AND GEARBOX INSTALLATION

A. Raise cutter using tractor 3-point lift. Turn off tractor engine.

B. **BLOCK CUTTER SECURELY INTO POSITION.**

⚠ WARNING

DO NOT GET UNDER CUTTER UNLESS IT IS SECURELY BLOCKED IN POSITION. ACCIDENTAL FALL COULD CAUSE SERIOUS INJURY OR DEATH.

C. Attach gearbox to cutter deck using bolts and flange nuts.

D. Install blade holder onto gearbox securing with castellated nut and flat washer. Torque nut to 350 ft./lbs. (475 Nm). Wear heavy work gloves to protect hands from sharp edges.

E. Install cotter pin to retain nut. It may be necessary to slightly loosen nut to install cotter pin.

F. Slide driveline yoke onto gearbox input shaft. Install retaining clip and shear bolt.

⚠ WARNING

FAILURE TO INSTALL RETAINING CLIP WILL ALLOW DRIVELINE TO swing FREELY IF BOLT IS SHEARED CAUSING POSSIBLE INJURY OR DEATH.

G. Lock yoke shield securely into place.

H. Fill gearbox with oil per paragraph 4-2.

4-7 TROUBLESHOOTING

Troubleshooting procedures are listed in Table 4-2. If the problem cannot be solved or replacement parts are necessary, contact your authorized Bush Hog dealer.

Please have ready your machine name, model number, serial number, purchase date and exact cause or description of problem.

TABLE 4-2 GENERAL TROUBLESHOOTING

PROBLEM	PROBABLE CAUSE	REMEDY
Uneven Cut	Cutter not level side to side or front to rear	Refer to SECTION II.
	Worn or bent blades	Replace blades per paragraph 4-3.
Stripping or Windrowing	Possible build up of material under cutter	Clean cutter.
	Cutter not level	Refer to SECTION II.
	Worn blades	Replace per paragraph 4-3.
	Cutter not being operated at rated RPM speed	Set tractor throttle for proper PTO speed during operation.
Noisy Cutter	Loose components	Check all bolts for tightness per Torque Specifications.
	Low oil in gearbox	Check for proper oil level Refer to paragraph 4-2.
Rapid blade wear (cutting edge)	Blade contacting the ground	Adjust cutter to operate at a height that will eliminate ground contact.
Rapid blade wear (bolt hole)	Cutter not being operated at rated RPM speed	Set tractor for proper PTO speed during operation.
Cutter vibration	Cutter not being operated at rated RPM speed	Set tractor throttle for proper PTO speed during operation.
	Blades have unequal weight	Replace blades with matched set.
	Blades not swinging free	Repair / replace blades and / or blade bolts.

SECTION V DEALER ASSEMBLY

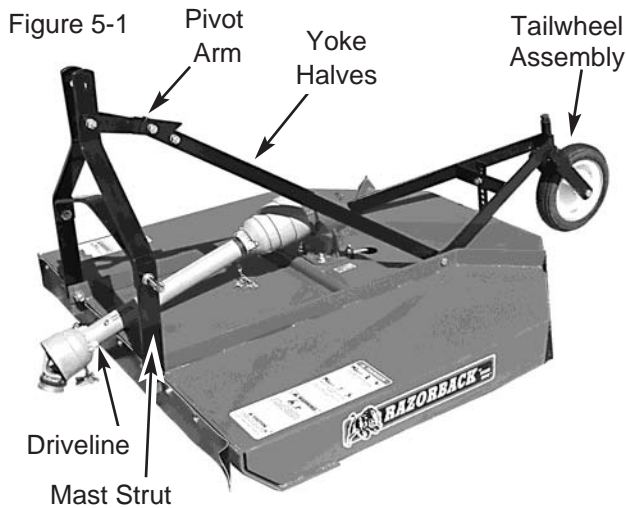

5-1 BASE UNIT ASSEMBLY

A. During shipping the yoke halves will be fastened to the bolts at the bottom of the mast halves. Remove the nuts and detach the yoke halves from the mast struts.

B. The yoke halves will be fastened later to the strongbacks using the same 5/8" x 2" capscrews that fasten the tailwheel frame to the strongbacks.

C. Remove fasteners from the pivot arm and yoke halves. Assemble the pivot arm link to the yoke halves using 5/8" x 2" capscrews, bushings and locknuts as shown in Figure 5-2.

D. Attach wheel assembly to caster fork using a 3/4 x 7-1/2" bolt and locknut. (Figure 5-3)

E. Install caster fork and wheel assembly onto tailwheel frame securing with roll pin.

F. Attach adjusting strap to cutter deck using a 5/8 x 1-1/2" bolt, lockwasher and nut.

G. Attach tailwheel assembly and yoke halves to cutter deck using two 5/8 x 2" bolts, bushings, flatwashers and locknuts. Do not overtighten nuts to allow assembly to pivot.

H. Secure tailwheel assembly to adjusting strap using a 5/8 x 1-1/2" bolt, lockwasher and nut.

I. Attach driveline to gearbox using a 1/2 x 3" Grade 2 bolt and locknut.

J. Fill gearbox with 18 ozs. EP80W-90 gear oil.

5-2 FRONT AND REAR SHIELDING INSTALLATION

A. Attach metal band to rear of cutter using six 3/8 x 1" bolts, lockwashers and nuts. Bolt should be installed with head to inside of cutter. (Figure 5-3)

B. Attach flexible shield to front of cutter using (9) 5/16 x 1-1/4" bolts, (18) flatwashers, and (9) locknuts. (Figure 5-4)

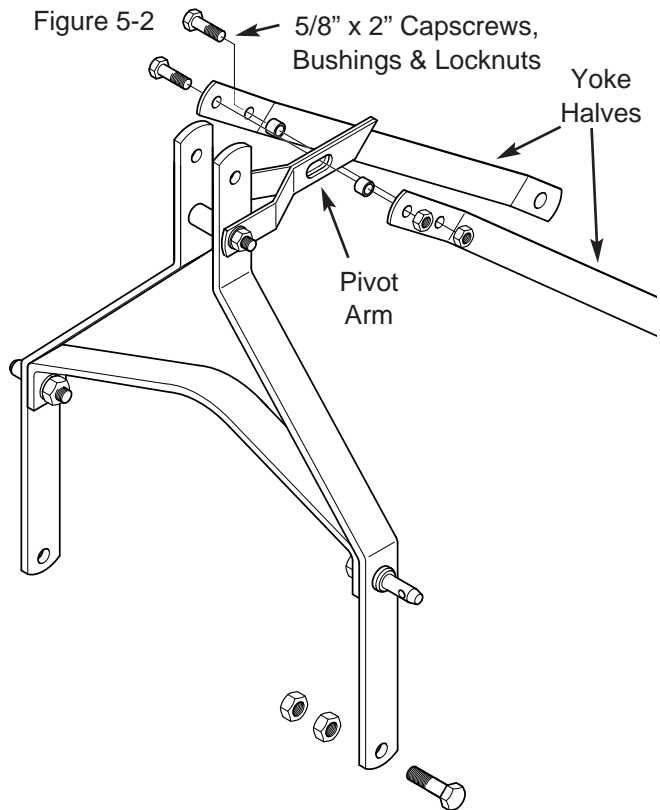

Figure 5-3 5/8 x 2" Bolt, Bushing, Flatwasher & Nut

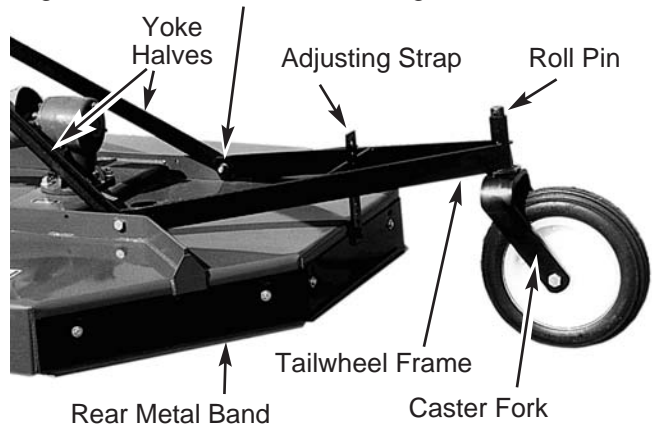
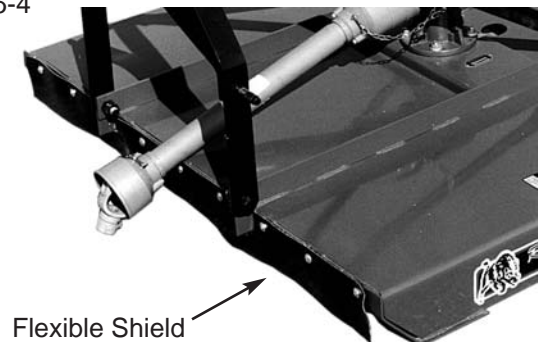

Figure 5-4



SAFETY DECALS

To promote safe operation, Bush Hog supplies safety decals on all products manufactured. Because damage can occur to safety decals either through shipment, use or reconditioning, Bush Hog will, upon request, provide safety decals for any of our products in the field at no charge. Contact your authorized Bush Hog dealer for more information.

⚠ DANGER

KEEP AWAY - ROTATING BLADES

TO AVOID SERIOUS INJURY OR DEATH FROM BLADE CONTACT:

- LOWER IMPLEMENT, STOP ENGINE AND PTO, ALLOW ALL MOVING PARTS TO STOP, AND REMOVE KEY BEFORE DISMOUNTING FROM TRACTOR.
- ALLOW NO RIDERS ON TRACTOR OR MOWER.
- KEEP ALL PERSONS CLEAR OF OPERATING MOWER AND MOVING AREA.
- KEEP CLEAR OF ROTATING BLADES, PARTS, AND DRIVELINES.

PREVENT FALL OFF INTO ROTATING BLADES

TO PREVENT ACCIDENTAL FALL OFF FROM TRACTOR AND SERIOUS INJURY OR DEATH FROM RUN OVER OR ROLLOVER BY TRACTOR OR MOWER:

- USE ROPS (ROLOVER PROTECTIVE STRUCTURES) AND SEAT BELT EQUIPPED TRACTORS FOR MOWING OPERATIONS.
- BUCKLE UP SEAT BELT.
- KEEP ALERT FOR STUMPS, HOLES, RUTS AND UNEVEN TERRAIN.

⚠ WARNING

ROTARY CUTTERS CAN DISCHARGE OBJECTS SEVERAL HUNDREDS OF FEET. TO AVOID SERIOUS INJURY OR DEATH TO BYSTANDERS FROM THROWN OBJECTS:

- CLEAR MOWING AREA OF VISIBLE DEBRIS AND USE EXTRA CAUTION WHERE ROCKS OR DEBRIS MAY BE PRESENT.
- DO NOT OPERATE CUTTER ALONG ROADWAYS OR IN THE VICINITY OF OTHER PERSONS WITHOUT ENCLOSED SIDES, PERMANENT BANDS, BELTING, HIGHWAY CHAINS OR OTHER FACTORY APPROVED DISCHARGE SHIELDS IN PLACE AND IN GOOD WORKING ORDER.
- KEEP ALL PERSONS WELL CLEAR OF MOWER WHEN IN OPERATION.

⚠ CAUTION

THIS IMPLEMENT IS DESIGNED TO OPERATE AT 540 RPM MAXIMUM TRACTOR PTO SPEED.

ALL DRIVE LINE SHIELDS MUST BE KEPT IN PLACE.

50029417

⚠ WARNING

TO AVOID SERIOUS INJURY OR DEATH:

- READ OPERATOR'S MANUAL BEFORE OPERATING AND FOLLOW ALL PRECAUTIONS. (CONTACT DEALER FOR MANUAL)
- KEEP SHIELDS AND GUARDS IN PLACE. KEEP CLEAR OF DRIVES AND BELTS.
- LOWER IMPLEMENT, STOP ENGINE AND PTO, ALLOW ALL MOVING PARTS TO STOP, AND REMOVE KEY BEFORE DISMOUNTING FROM TRACTOR.
- KNOW HOW TO STOP TRACTOR AND EQUIPMENT QUICKLY IN AN EMERGENCY.
- ALLOW NO CHILDREN OR UNQUALIFIED PERSONS TO OPERATE EQUIPMENT.
- BE CAREFUL ON UNEVEN TERRAIN. DECREASE SPEED WHEN TURNING.
- DO NOT OPERATE MOWER IN TRANSPORT POSITION.

⚠ WARNING

IMPLEMENT CAN FALL FROM HYDRAULIC SYSTEM RELEASE. TO AVOID SERIOUS INJURY OR DEATH:

- SHUT OFF TRACTOR ENGINE, REMOVE KEY, SECURE TRACTOR PARKING BRAKE AND BLOCK UP OR SECURELY SUPPORT IMPLEMENT BEFORE WORKING UNDERNEATH.
- PURGE ALL AIR FROM HYDRAULIC SYSTEM BEFORE ATTEMPTING TO RAISE OR LOWER THIS IMPLEMENT.
- STAND CLEAR IF LOWERING OR RAISING IMPLEMENT.
- DO NOT USE HAND OR SKIN TO CHECK FOR HYDRAULIC LEAKS. USE CARDBOARD OR WOOD.
- HIGH PRESSURE OIL LEAKS CAN PENETRATE SKIN CAUSING SERIOUS INJURY AND GANGRENE. CONSULT A PHYSICIAN IMMEDIATELY.
- LOWER THE IMPLEMENT AND RELEASE HYDRAULIC PRESSURE BEFORE LOOSENING FITTINGS.
- REFER TO OWNER'S MANUAL FOR DETAILS.

50029419

⚠ DANGER

**ROTATING DRIVELINE CONTACT CAN CAUSE DEATH
KEEP AWAY!**

DO NOT OPERATE WITHOUT -

- ALL DRIVELINE GUARDS, TRACTOR AND EQUIPMENT SHIELDS IN PLACE
- DRIVELINES SECURELY ATTACHED AT BOTH ENDS
- DRIVELINE GUARDS THAT TURN FREELY ON DRIVELINE

BONDIOLI & PAVESI

78608

⚠ DANGER

**GUARD MISSING
DO NOT OPERATE**

⚠ DANGER

**GUARD MISSING
DO NOT OPERATE**

⚠ DANGER

78786

TORQUE SPECIFICATIONS

Proper torque for American fasteners used on Bush Hog equipment.
Recommended Torque in Foot Pounds (Newton Meters).*

AMERICAN Bolt Head Markings

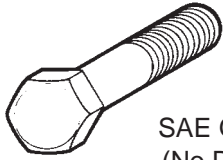

SAE Grade 2
(No Dashes)

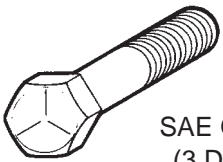

SAE Grade 5
(3 Dashes)

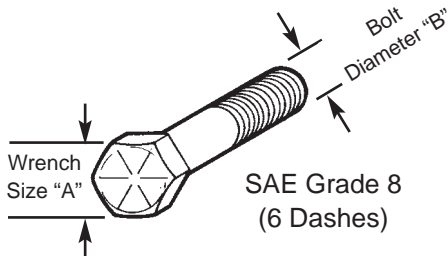

SAE Grade 8
(6 Dashes)

WRENCH SIZE (IN.) "A"	BOLT DIAMETER (IN.) "B" AND THREAD SIZE	SAE GRADE 2	SAE GRADE 5	SAE GRADE 8
7/16	1/4 - 20 UNC	6 (7)	8 (11)	12 (16)
7/16	1/4 - 28 UNF	6 (8)	10 (13)	14 (18)
1/2	5/16 - 18 UNC	11 (15)	17 (23)	25 (33)
1/2	5/16 - 24 UNF	13 (17)	19 (26)	27 (37)
9/16	3/8 - 16 UNC	20 (27)	31 (42)	44 (60)
9/16	3/8 - 24 UNF	23 (31)	35 (47)	49 (66)
5/8	7/16 - 14 UNC	32 (43)	49 (66)	70 (95)
5/8	7/16 - 20 UNF	36 (49)	55 (75)	78 (106)
3/4	1/2 - 13 UNC	49 (66)	76 (103)	106 (144)
3/4	1/2 - 20 UNF	55 (75)	85 (115)	120 (163)
7/8	9/16 - 12 UNC	70 (95)	109 (148)	153 (207)
7/8	9/16 - 18 UNF	79 (107)	122 (165)	172 (233)
15/16	5/8 - 11 UNC	97 (131)	150 (203)	212 (287)
15/16	5/8 - 18 UNF	110 (149)	170 (230)	240 (325)
1-1/8	3/4 - 10 UNC	144 (195)	266 (360)	376 (509)
1-1/8	3/4 - 16 UNF	192 (260)	297 (402)	420 (569)
1-5/16	7/8 - 9 UNC	166 (225)	430 (583)	606 (821)
1-5/16	7/8 - 14 UNF	184 (249)	474 (642)	668 (905)
1-1/2	1 - 8 UNC	250 (339)	644 (873)	909 (1232)
1-1/2	1 - 12 UNF	274 (371)	705 (955)	995 (1348)
1-1/2	1 - 14 UNF	280 (379)	721 (977)	1019 (1381)
1-11/16	1-1/8 - 7 UNC	354 (480)	795 (1077)	1288(1745)
1-11/16	1-1/8 - 12 UNF	397 (538)	890 (1206)	1444 (1957)
1-7/8	1-1/4 - 7 UNC	500 (678)	1120 (1518)	1817 (2462)
1-7/8	1-1/4 - 12 UNF	553 (749)	1241 (1682)	2013 (2728)
2-1/16	1-3/8 - 6 UNC	655 (887)	1470 (1992)	2382 (3228)
2-1/16	1-3/8 - 12 UNF	746 (1011)	1672 (2266)	2712 (3675)
2-1/4	1-1/2 - 6 UNC	870 (1179)	1950 (2642)	3161 (4283)
2-1/4	1-1/2 - 12 UNF	979 (1327)	2194 (2973)	3557 (4820)

METRIC

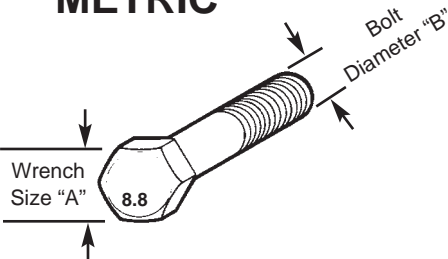

Numbers appearing on bolt heads indicate ASTM class.

Proper torque for metric fasteners used on Bush Hog equipment.
Recommended torque in foot pounds (newton Meters).*

WRENCH SIZE (mm) "A"	BOLT DIA. (mm) "B"	ASTM 4.6	ASTM 8.8	ASTM 9.8	ASTM 10.9
8	5	1.8 (2.4)		5.1 (6.9)	6.5 (8.8)
10	6	3 (4)		8.7 (12)	11.1 (15)
13	8	7.3 (10)		21.1 (29)	27 (37)
16	10	14.5 (20)		42 (57)	53 (72)
18	12	25 (34)	74 (100)	73 (99)	93 (126)
21	14	40 (54)	118 (160)	116 (157)	148 (201)
24	16	62 (84)	167 (226)	181 (245)	230 (312)
30	20	122 (165)	325 (440)		449 (608)
33	22		443 (600)		611 (828)
36	24	211 (286)	563 (763)		778 (1054)
41	27		821 (1112)		1138 (1542)
46	30	418 (566)	1119 (1516)		1547 (2096)

*Use 75% of the specified torque value for plated fasteners. Use 85% of the specified torque values for lubricated fasteners.



BUSH HOG®
Performance You Can Count OnSM

P.O. Box 1039 • Selma, AL 36702-1039
Telephone (334) 874-2700 • www.bushhog.com