

BUSH HOG®

Model PHD2403 Post Hole Digger Operator's Manual

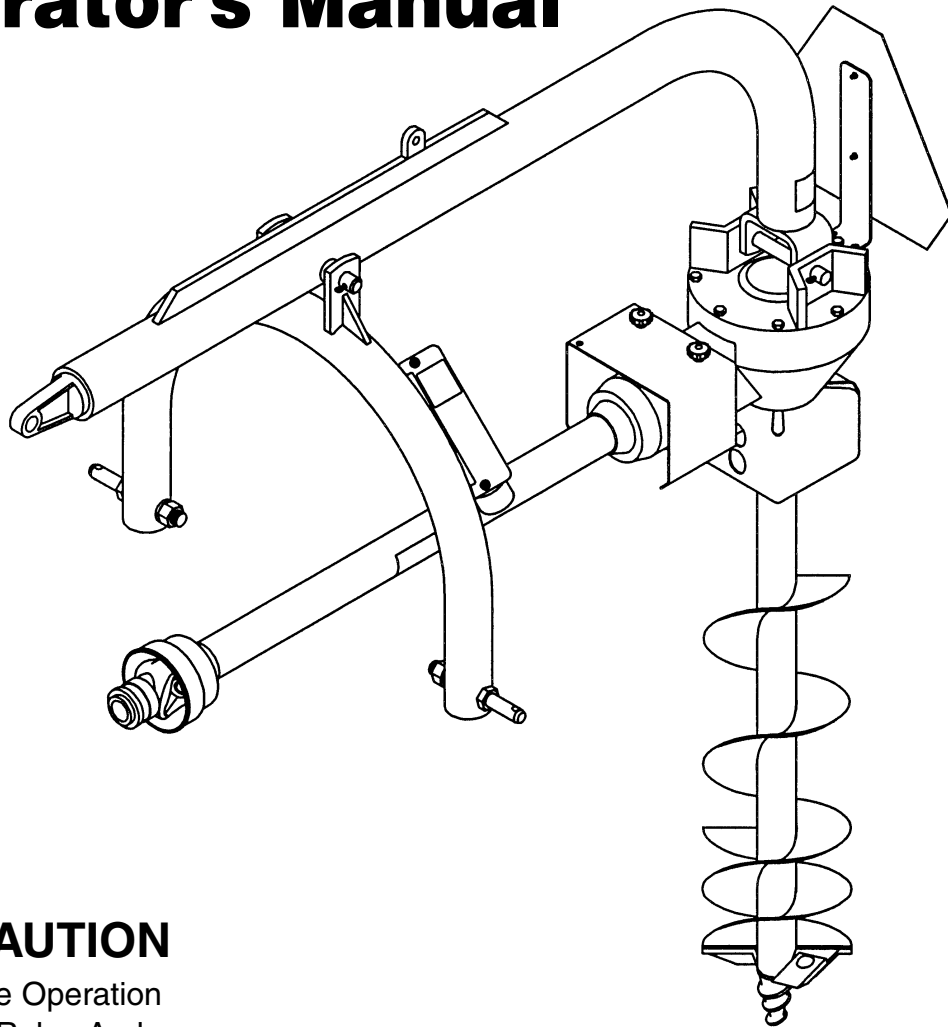

CAUTION

For Safe Operation
Read Rules And
Instructions Carefully

SI NO LEEINGLES, PIDA AYUDA
A AIGUIEN QUE SI LO LEA
PARA QUE LE TRADUZCA LAS
MEDIDAS DE SEGURIDAD.



BUSH HOG®
Performance You Can Count On™

ASSEMBLY • OPERATION • MAINTENANCE

CONGRATULATIONS!

You have invested in the best implement of its type on the market today.

The care you give your Bush Hog implement will greatly determine your satisfaction with its performance and its service life. We urge a careful study of this manual to provide you with a thorough understanding of your new implement before operating, as well as suggestions for operation and maintenance.

If your manual should become lost or destroyed, Bush Hog will be glad to provide you with a new copy. Order from Bush Hog, 2501 Griffin Ave., Selma, Alabama 36703.

As an authorized Bush Hog dealer, we stock genuine Bush Hog parts which are manufactured with the same precision and skill as our original equipment. Our trained service personnel are well informed on methods required to service Bush Hog equipment, and are ready and able to help you.

Should you require additional information or assistance, please contact us.

YOUR AUTHORIZED
BUSH HOG DEALER

BECAUSE BUSH HOG MAINTAINS AN ONGOING PROGRAM OF PRODUCT IMPROVEMENT, WE RESERVE THE RIGHT TO MAKE IMPROVEMENTS IN DESIGN OR CHANGES IN SPECIFICATIONS WITHOUT INCURRING ANY OBLIGATION TO INSTALL THEM ON UNITS PREVIOUSLY SOLD.

BECAUSE OF THE POSSIBILITY THAT SOME PHOTOGRAPHS IN THIS MANUAL WERE TAKEN OF PROTOTYPE MODELS, PRODUCTION MODELS MAY VARY IN SOME DETAIL. IN ADDITION, SOME PHOTOGRAPHS MAY SHOW SHIELDS REMOVED FOR PURPOSES OF CLARITY. **NEVER OPERATE** THIS IMPLEMENT WITHOUT ALL SHIELDS IN PLACE.

PHD2403 Post Hole Digger Operator's Manual

TABLE OF CONTENTS

WARRANTY INFORMATION	2-3
DEALER CHECKLIST	4
FEDERAL LAWS AND REGULATIONS.....	5
IMPORTANT SAFETY INFORMATION	6-14
GENERAL SAFETY AND PREPARATION.....	6-7
PERSONAL PROTECTIVE EQUIPMENT	7
OPERATING SAFETY	8-10
REPAIR AND MAINTENANCE SAFETY	10-11
SAFETY DECALS	13-14
INTENDED USE.....	15
ASSEMBLY INSTRUCTIONS.....	15-17
OPERATING INSTRUCTIONS.....	17-20
GENERAL MAINTENANCE	21
TROUBLE-SHOOTING GUIDE	22-23
PARTS BREAKDOWN ILLUSTRATION	24
AUGER BREAKDOWN ILLUSTRATION	25
HYDRAULIC DOWN FORCE KIT	26
OPTIONAL PARKING STAND	27
TORQUE SPECIFICATIONS	28
SPECIFICATIONS	29
NOTES	29

RETAIL CUSTOMER'S RESPONSIBILITY UNDER THE BUSH HOG WARRANTY

It is the Retail Customer and/or Operator's responsibility to read the Operator's Manual, to operate, lubricate, maintain, and store the product in accordance with all instructions and safety procedures. Failure of the operator to read the Operator's Manual is a misuse of this equipment.

It is the Retail Customer and/or Operator's responsibility to inspect the product and to have any part(s) repaired or replaced when continued operation would cause damage or excessive wear to other parts or cause a safety hazard.

It is the Retail Customer's responsibility to deliver the product to the authorized Bush Hog Dealer, from whom he purchased it, for service or replacement of defective parts which are covered by warranty. Repairs to be submitted for warranty consideration must be made within forty-five (45) days of failure.

It is the Retail Customer's responsibility for any cost incurred by the Dealer for traveling to or hauling of the product for the purpose of performing a warranty obligation or inspection.

TO THE OWNER:

Read this manual before using your Post Hole Digger. This manual is provided to give you the necessary operating and maintenance instructions for keeping your Post Hole Digger in top operating condition. Please read this manual thoroughly. Understand what each control is for and how to use it. Observe all safety signs on the machine and noted throughout the manual for safe operation of implement. Keep this manual handy for ready reference.

Like all mechanical products, it will require cleaning and upkeep.

Use only genuine Bush Hog service parts. Substitute parts will void the warranty and may not meet standards required for safe and satisfactory operation. Record the model and serial number of your Attachment here:

Model: _____

Serial Number: _____



LIMITED WARRANTY

Bush Hog warrants to the original purchaser of any new Bush Hog equipment, purchased from an authorized Bush Hog dealer, that the equipment be free from defects in material and workmanship for a period of two (2) years for non-commercial, state, and municipalities' use and ninety (90) days for commercial use from date of retail sale. The obligation of Bush Hog to the purchaser under this warranty is limited to the repair or replacement of defective parts.

Replacement or repair parts installed in the equipment covered by this limited warranty are warranted for ninety (90) days from the date of purchase of such part or to the expiration of the applicable new equipment warranty period, whichever occurs later. Warranted parts shall be provided at no cost to the user at an authorized Bush Hog dealer during regular working hours. Bush Hog reserves the right to inspect any equipment or parts which are claimed to have been defective in material or workmanship.

NOTICE: Bush Hog is NOT responsible for damage to augers caused by hitting underground objects (rocks, roots, etc.) or for bent augers caused by moving the tractor with the auger in the ground.

DISCLAIMER OF IMPLIED WARRANTIES & CONSEQUENTIAL DAMAGES

Bush Hog's obligation under this warranty, to the extent allowed by law, is in lieu of all warranties, implied or expressed, **INCLUDING IMPLIED WARRANTIES OF MERCHANTABILITY AND FITNESS FOR A PARTICULAR PURPOSE** and any liability for incidental and consequential damages with respect to the sale or use of the items warranted. Such incidental and consequential damages shall include but not be limited to: transportation charges other than normal freight charges; cost of installation other than cost approved by Bush Hog; duty; taxes; charges for normal service or adjustments; loss of crops or any other loss of income; rental of substitute equipment, expenses due to loss, damage, detention or delay in the delivery of equipment or parts resulting from acts beyond the control of Bush Hog.

THIS WARRANTY SHALL NOT APPLY:

1. To vendor items which carry their own warranties, such as hydraulic cylinders, tires, and tubes.
2. If the unit has been subjected to misapplication, abuse, misuse, negligence, fire or other accident.
3. If parts not made or supplied by Bush Hog have been used in connection with the unit, if, in sole judgement of Bush Hog such use affects its performance, stability, or reliability.
4. If the unit has been altered or repaired outside of an authorized Bush Hog dealership in a manner which, in the sole judgement of Bush Hog affects its performance, stability or reliability.
5. To normal maintenance service and normal replacement items such as gearbox lubricant, hydraulic fluid, worn blades, or to normal deterioration of such things as belts, seals, and exterior finish, due to use or exposure.
6. To expendable or wear items such as teeth, chains, center points, belts, springs and other items that in the company's sole judgement is a wear item.

NO EMPLOYEE OR REPRESENTATIVE OF BUSH HOG IS AUTHORIZED TO CHANGE THIS WARRANTY IN ANY WAY OR GRANT ANY OTHER WARRANTY UNLESS SUCH CHANGE IS MADE IN WRITING AND SIGNED BY BUSH HOG'S SERVICE MANAGER, 2501 GRIFFIN AVE., SELMA, ALABAMA 36703.

Record the model number, serial number and date purchased. This information will be helpful to your dealer if parts or service are required.

DEALER PREPARATION CHECK LIST

Post Hole Diggers

BEFORE DELIVERING MACHINE – The following check list should be completed. Use the Operator's Manual as a guide.

- Assembly completed
- Gearbox filled to proper level with oil
- Driveline shields are in place with no damage
- Gearbox and auger shields are in place
- SMV Sign and bracket installed
- All safety decals readable (see decal page)
- All bolts tight to torque specifications given on torque chart
- Operator's manual has been delivered to owner and he has been instructed on the safe and proper use of the post hole digger.

Dealer's
Signature _____

THIS CHECK LIST TO REMAIN IN OPERATOR'S MANUAL
It is the responsibility of the dealer to complete the procedure above before delivery of this implement to the customer.

SAFETY

Federal Laws and Regulations

This section is intended to explain in broad terms the concept and effect of federal laws and regulations concerning employer and employee equipment operators. This section is not intended as a legal interpretation of the law and should not be considered as such.

Employer-Employee Operator Regulations

U.S. Public Law 91-596 (The Williams-Steiger Occupational and Health Act of 1970) OSHA

This Act Seeks:

"...to assure so far as possible every working man and woman in the nation safe and healthful working conditions and to preserve our human resources..."

DUTIES

Sec. 5 (a) Each employer-

- (1) shall furnish to each of his employees employment and a place of employment which are free from recognized hazards that are causing or are likely to cause death or serious physical harm to his employees;
- (2) shall comply with occupational safety and health standards promulgated under this Act.
- (b) Each employee shall comply with occupational safety and health standards and all rules, regulations and orders issued pursuant to this Act which are applicable to his own actions and conduct.

OSHA Training Requirements

Title 29, Code of Federal Regulations Part 1928.57(a)(6). www.osha.gov

Operator instructions. At the time of initial assignment and at least annually thereafter, the employer shall instruct every employee who operates an agricultural tractor and implements in the safe operating practices and servicing of equipment with which they are or will be involved, and of any other practices dictated by the work environment.

Keep all guards in place when the machine is in operation;

Permit no riders on equipment

Stop engine, disconnect the power source, and wait for all machine movement to stop before servicing, adjusting, cleaning or unclogging the equipment, except where the machine must be running to be properly serviced or maintained, in which case the employer shall instruct employees as to all steps and procedures which are necessary to safely service or maintain the equipment.

Make sure everyone is clear of machinery before starting the engine, engaging power, or operating the machine.

The best training information is found in this Operator's Manual. Read, understand, and follow the instructions in this manual.

Employer Responsibilities:

To ensure employee safety during Tractor and Implement operation, it is the employer's responsibility to:

1. Train the employee in the proper and safe operation of the Tractor and Implement.
2. Require that the employee read and fully understand the Tractor and Implement Operator's manual.
3. Permit only qualified and properly trained employees to operate the Tractor and Implement.
4. Maintain the Tractor and Implement in a safe operational condition and maintain all shields and guards on the equipment.
5. Ensure the Tractor is equipped with a functional ROPS and seat belt and require that the employee operator securely fasten the safety belt and operate with the ROPS in the raised position at all times.
6. Forbid the employee operator to carry additional riders on the Tractor or Implement.
7. Provide the required tools to maintain the Tractor and Implement in a good safe working condition and provide the necessary support devices to secure the equipment safely while performing repairs and service.
8. Require that the employee operator stop operation if bystanders or passersby come within 25 feet.

Child Labor Under 16 Years of Age

Some regulations specify that no one under the age of 16 may operate power machinery. It is your responsibility to know what these regulations are in your own area or situation. (Refer to U.S. Dept. of Labor, Employment Standard Administration, Wage & Home Division, Child Labor Bulletin #102.)

To the Owner/Operator/Dealer

All implements with moving parts are potentially hazardous. There is no substitute for a cautious, safe-minded operator who recognizes the potential hazards and follows reasonable safety practices. The manufacturer has designed this implement to be used with all its safety equipment properly attached to minimize the chance of accidents.

BEFORE YOU START!!

**Read the safety messages on the implement and shown in your manual.
Observe the rules of safety and common sense!**





THIS SYMBOL MEANS

- ATTENTION!**
- BECOME ALERT!**
- YOUR SAFETY IS INVOLVED!**

THIS SAFETY ALERT SYMBOL IDENTIFIES IMPORTANT SAFETY WARNING MESSAGES. CAREFULLY READ EACH WARNING MESSAGE THAT FOLLOWS. FAILURE TO UNDERSTAND AND OBEY A SAFETY WARNING, OR RECOGNIZE A SAFETY HAZARD, COULD RESULT IN AN INJURY OR DEATH TO YOU OR OTHERS AROUND YOU. THE OPERATOR IS ULTIMATELY RESPONSIBLE FOR THE SAFETY OF HIMSELF, AS WELL AS OTHERS, IN THE OPERATING AREA OF THE TRACTOR AND ATTACHED EQUIPMENT.

UNDERSTAND SIGNAL WORDS

- | | | |
|--|----------------|---|
|  | DANGER | Indicates an imminently hazardous situation that, if not avoided, WILL result in DEATH OR VERY SERIOUS INJURY. |
|  | WARNING | Indicates a imminently hazardous situation that, if not avoided, COULD result in DEATH OR SERIOUS INJURY. |
|  | CAUTION | Indicates a imminently hazardous situation that, if not avoided, MAY result in MINOR INJURY. |
| IMPORTANT | | Identifies special instructions or procedures that, if not strictly observed, could result in damage to, or destruction of the machine, attachments or the environment. |

NOTE: *Identifies points of particular interest for more efficient and convenient operation or repair.*

If you have questions not answered in this manual or require additional copies or the manual is damaged, please contact your dealer or the manufacturer directly.

IMPORTANT SAFETY INFORMATION!

Working with equipment can lead to injuries. Read this manual, and the manual for your tractor, before assembly or operating, to acquaint yourself with the machines. It is the implement owner's responsibility, if this machine is used by any person other than yourself, is loaned or rented, to make certain that the operator, prior to operating:

1. Reads and understands the operator's manuals.
2. Is instructed in safe and proper use.

-  The use of this equipment is subject to certain hazards which cannot be protected against by mechanical means or product design. All operators of this equipment must read and understand this entire manual, paying particular attention to safety and operating instructions, prior to using. If there is something in this manual you do not understand, ask your supervisor, or your dealer, to explain it to you.

SAFETY INSTRUCTIONS (continued)



EQUIPMENT SAFETY GUIDELINES

Safety of the operator is one of the main concerns in designing and developing a new piece of equipment. Designers and manufacturers build in as many safety features as possible. However, every year many accidents occur which could have been avoided by a few seconds of thought and a more careful approach to handling equipment. You, the operator, can avoid many accidents by observing the following precautions in this section. To avoid personal injury, study the following precautions and insist those working with you, or for you, follow them.

In order to provide a better view, certain photographs or illustrations in this manual may show an assembly with a safety shield removed. However, equipment should never be operated in this condition. Keep all shields in place. If shield removal becomes necessary for repairs, replace the shield prior to use.



Replace any CAUTION, WARNING, DANGER or instruction safety sign that is not readable or is missing. Do not paint over, remove or deface any safety signs or warning signs on your equipment. Observe all safety signs and practice the instruction on them. Review the safety instructions with all users annually.



This equipment is dangerous to children and persons unfamiliar with its operation. The operator should be a responsible adult familiar with farm machinery and trained in this equipment's operations. **Do not allow persons to operate or assemble this unit until they have read this manual and have developed a thorough understanding of the safety precautions and of how it works.**



To prevent injury or death, use a tractor equipped with a Roll-Over Protective System (ROPS). Keep foldable ROPS systems in "locked up" position at all times.



Never use alcoholic beverages or drugs which can hinder alertness or coordination while operating this equipment. Consult your doctor about operating this machine while taking prescription or over the counter medications.



Personal protection equipment including hard hat, safety glasses, safety shoes, and gloves are recommended during assembly, installation, operation, adjustment, maintaining, repairing, removal, or moving the implement. Do not allow long hair, loose fitting clothing or jewelry to be around moving parts.



Never exceed the limits of a piece of machinery. If its ability to do a job, or to do so safely, is in question – **DON'T TRY IT.**



Do not modify the equipment in any way. Unauthorized modification may impair the function and/or safety and could affect the life of the equipment.



In addition to the design and configuration of this implement, including Safety Signs and Safety Equipment, hazard control and accident prevention are dependent upon the awareness, concern, prudence, and proper training of personnel involved in the operation, transport, maintenance, and storage of the machine. Refer also to Safety Messages and Operation Instructions in each of the appropriate sections of the Tractor and Implement Manuals. Pay close attention to the Safety Signs affixed to the Tractor and the Implement.















WARNING Cancer and Reproductive Harm www.P65Warnings.ca.gov

SAFETY INSTRUCTIONS (continued)



OPERATIONAL SAFETY

-  Start tractor only when properly seated in the tractor seat. Starting a tractor in gear can result in injury or death. Do not mount or dismount the tractor while the tractor is moving. Mount or dismount the tractor only when the tractor and all moving parts are completely stopped.
-  Operate the tractor and/or implement controls only while properly seated in the tractor seat with the seat belt securely fastened around you. Inadvertent movement of the tractor or implement may cause serious injury or death.
-  This Post Hole Digger was designed for one-man operation from the tractor seat. It is the responsibility of the operator to see that no one is within twenty-five feet (25') of the digger when it is started. Do not operate the digger with another person near, or in contact with, any part of the digger, PTO driveline, or auger. Serious personal injury or death may result if any attempt is made to assist digger operation by hand.
-  Keep all helpers and bystanders twenty-five feet (25') from an operating digger. Only properly trained people should operate this machine. It is recommended the tractor be equipped with a Rollover Protection System (ROPS) and a seat belt that is used. Always stop the PTO, set brake, shut off the tractor engine, remove the tractor key, and allow auger to come to a complete stop before dismounting tractor. Never leave equipment unattended with the tractor running.
-  Never leave the tractor and implement unattended while the implement is in the lifted position. Accidental operation of lifting lever or a hydraulic failure may cause sudden drop of unit with injury or death by crushing.
-  Know your controls and how to stop tractor, engine, and implement quickly in an emergency. Read this manual and the one provided with your tractor.
-  Clear area of stones, branches or other debris that might be thrown or entangled, causing injury or damage.
-  Operate only in daylight or good artificial light.
-  Make sure driveline spring-activated locking pin or balls operate freely and are seated firmly in tractor PTO stub shaft groove.
-  Do not allow children or others to ride on the tractor with an operator. Riders are subject to injury such as being struck by foreign objects or being thrown off. Riders obstruct the operator's view resulting in unsafe operation. **Never allow anyone to ride on the implement!**
-  Never allow children to play on or around tractor or implement. Children can slip or fall off the equipment and be injured or killed. Inadvertent contact with controls can cause the implement to shift or fall crushing themselves or others.
-  Ensure that all safety shielding and safety signs are properly installed and in good condition. If a safety shield or guard is removed for any reason, it must be replaced before the machine is again operated. Always use, and maintain in place, all power take off guards furnished with the tractor as well as the power take off guards and shields furnished with the digger.

SAFETY INSTRUCTIONS (continued)



OPERATIONAL SAFETY (continued)

This digger is designed for use only on tractors with 540 RPM power take off.



Do not operate the post hole digger near existing fence wire. Fencing wire, loose wire, cable, landscape webbing or other similar debris can become entangled in the auger and be rapidly pulled into the auger along with bystanders in contact with the material. This can result in serious injury or death. Inspect the area before digging and remove any fencing material, wire, cable, chain, rope, landscaping webbing or other similar debris that could become entangled in the auger. Keep all bystanders 25 feet away from the auger and any wire of fencing material near the auger.



Never place yourself or allow anyone between or near the tractor and digger while implement is in operation.



Do not walk or work under a raised digger or attachment unless it is securely blocked or held in position. Do not depend on the tractor hydraulic system to hold the digger or attachment in place.



A heavy load can cause instability of the tractor. Use extreme care during travel. Slow down on turns and watch out for bumps. The tractor may need front counter-weights to counter-balance the weight of the digger.



Do not allow riders on the digger or tractor at any time. There is no safe place for any riders.



Know where the utilities are: Before operating, call your local utilities (call 811 or 1-800-258-0808) for location of buried utility lines, gas, water, sewer, and telephone, as well as any other hazard you may encounter.



Do not allow anyone who is not familiar with the safety rules and operation instructions to use this Post Hole Digger.



Never allow children to operate or be around this digger.



Use stabilizer bars, adjustable sway chains, or sway blocks on your tractor lift arms to keep the Post Hole Digger from swinging side to side. Adjust as tightly as practical for best performance.



Never replace the shear bolt OR auger retaining bolt with any length other than what is specified in this manual. A longer, or protruding fastener is more likely to grab loose clothing or gloves which can result in serious injury or death.



Do not operate digger on steep hillsides. When digging on uneven or hilly terrain, position the tractor with the Post Hole Digger uphill. With the Post Hole Digger downhill, the tractor could tip when attempting to pull the auger from its hole.













NEVER put hands on the post hole digger auger, gearbox, or boom to locate the auger when there is any sign of rotation of the driveline or auger. Post hole diggers are operated by one person from the tractor seat. Keep all bystanders and/or coworkers away from the post hole digger.

SAFETY INSTRUCTIONS (continued)





OPERATIONAL SAFETY (continued)

-  Inspect the entire machine periodically as indicated in the Maintenance Section of this manual. Look for loose fasteners, worn or broken parts, pinched hydraulic hoses, and leaky or loose fittings. Make sure all pins have cotter pins and washers. Serious injury may occur from not maintaining this machine in good working order.
-  To prevent rapid wear of U-Joints and possible failure of drivelines, never lift auger point more than 8" off the ground with PTO operating.
-  To prevent possible instantaneous driveline failure, never move digger from hole-to-hole or transport while auger is rotating. This could lead to injury from flying pieces of the failed driveline.
-  Relieve hydraulic pressure prior to doing any maintenance or repair work on the implement. Place the implement on the ground or securely blocked up, disengage the PTO, and turn off the tractor engine. Push and pull the remote hydraulic lever in and out several times prior to starting any maintenance or repair work.
-  To prevent entanglement and possible serious injury or death, never use body weight to try to push auger into the ground.
-  Worn cutting edges or a slightly rounded center point can seriously effect auger penetration. Check for wear before each use, replace as necessary.
-  Do not shovel dirt away from a rotating auger as the shovel can be caught and thrown by the auger.
-  Do not operate the Post Hole Digger without all safety shields and guards in place.
-  Take all possible precautions when leaving unit unattended: Disengage PTO, lower 3 pt., set parking brake, stop engine and remove key from ignition. Park in level area.
-  Before operating equipment: if you have any questions regarding the proper assembly or operation, contact your dealer or representative.



MAINTENANCE SAFETY

Good maintenance is your responsibility. Poor maintenance is an invitation to trouble.

-  Before working on this machine, drive to a level area, disengage the PTO, lower implement (or if working underneath, raise and block securely), shut off the engine, set the brakes, and remove the ignition keys. Disconnect the PTO shaft from the tractor PTO before servicing the implement.
-  Always use two people to handle heavy, unwieldy components during assembly, installation, removal, or moving the digger.
-  Never work under equipment unless it is blocked securely. Never depend on hydraulic system to keep implement in raised position.

SAFETY INSTRUCTIONS (continued)



MAINTENANCE SAFETY (continued)



Keep all persons away from operator control area while performing adjustments, service, or maintenance.



Periodically tighten all bolts, nuts and screws and check that all cotter pins are properly installed to ensure unit is in a safe condition.



When completing a maintenance or service function, make sure all safety shields and devices are installed before placing unit in service.



Never use your hands to locate a hydraulic leak on attachments. Use a small piece of cardboard or wood. Hydraulic fluid escaping under pressure can penetrate the skin. Openings in the skin and minor cuts are susceptible to infection from hydraulic fluid. If injured by escaping hydraulic fluid, see a doctor at once. Gangrene and death can result. Without immediate medical treatment, serious infection and reactions can occur.

Safety is a primary concern in the design, manufacture, sale, and use of Post Hole Diggers. As manufacturers of Post Hole Diggers, we want to confirm to you, our customers, our concern for safety.

Our current production machines include, as standard equipment, guards or shields for auger adapters, drivelines, input shafts, and safety signs. Older machines can be retrofitted to add these new guards or shields and, of course, safety signs. If you have an older machine which does not have current standard safety equipment, please contact your dealer about bringing your machine up to the current level of safety.

Where replacement parts are necessary for periodic maintenance and servicing, genuine factory replacement parts must be used to restore your equipment to original specifications. The manufacturer will not claim responsibility for use of unapproved parts and/or accessories and other damages as a result of their use.

If equipment has been altered in any way from original design, the manufacturer does not accept any liability for injury or warranty.



TRANSPORT SAFETY



Comply with state and local laws governing highway safety and movement of farm machinery on public roads.



When driving the tractor and equipment on the road or highway under 20 mph (32 kph) at night or during the day, use flashing amber warning lights and a slow moving vehicle (SMV) identification emblem.



Make sure post hole digger transported on tractor rear 3 pt. hitch does not obstruct visibility of tractor's flashing lights or SMV sign.







Reduce speed when transporting mounted implements to avoid bouncing and momentary loss of steering control.

SAFETY INSTRUCTIONS (continued)







TRANSPORT SAFETY (continued)

-  Be aware of the operating conditions. Do not operate the tractor with weak or faulty brakes. When operating down a hill or on wet or rain slick roads, the braking distance increases; use extreme care and reduce your speed in these conditions. When operating in traffic, always use the tractor's flashing warning lights and reduce your speed. Be aware of traffic around you and watch out for the other guy.
-  Always be sure the implement is in the proper raised position and the PTO is turned off for transport.
-  Turn curves or go up or down hills only at a low speed and at a gradual steering angle. Make certain that at least 20% of the tractor's weight is on the front wheels to maintain safe steering. Slow down on rough or uneven surfaces, and loose gravel.
-  Use extreme care and maintain minimum ground speed when transporting on hillside, over rough ground and when operating close to ditches or fences. Be careful when turning sharp corners.
-  Never allow riders on either tractor or implement. Falling off can kill.



STORAGE SAFETY

-  Following operation, or when unhooking, stop the tractor, set the brakes, disengage the PTO, shut off the engine and remove the ignition keys.
-  Use extreme care to keep feet and hands from under the unit and clear of any pinch points. Never stand or allow another person to stand between a running tractor and the unit when disconnecting the implement from the tractor 3-point hitch.
-  Do not park equipment where it will be exposed to livestock for long periods of time. Damage and livestock injury could result.
-  Store the unit in an area away from human activity. Do not permit children to play on or around the stored unit.
-  Make sure all parked machines are on a hard, level surface and engage all safety devices. Storage location should be level and solid to make connecting and unconnecting to power unit easy.

NOTE: The optional parking stand may be used when post hole digger is not in operation. It will help prolong digger's life by keeping the unit off the ground where moisture and debris are more likely to collect causing undue damage to the digger. Also, the parking stand aids in mounting and dismounting the post hole digger to and from the tractor.

SAFETY INSTRUCTIONS (continued)



SAFETY SIGNS

Keep safety signs clean and legible at all times.

Replace safety signs that are missing or have become illegible.

Replaced parts that displayed a safety sign should also display the current sign.

Safety signs are available from your Distributor or Dealer Parts Department or the factory.

How to Install Safety Signs:

Be sure that the installation area is clean and dry. Be sure temperature is above 50°F (10°C).

Decide on the exact position before you remove the backing paper.

Remove the smallest portion of the split backing paper. Align the sign over the specified area and carefully press the small portion with the exposed sticky backing in place.

Slowly peel back the remaining paper and carefully smooth the remaining portion of the sign in place. Small air pockets can be pierced with a pin and smoothed out using the piece of sign backing paper.

SAFETY SIGNS AND DECALS

POST HOLE DIGGER INSTRUCTIONS

1. Fill gearbox to the inspection hole with number 90 weight transmission grease. Check often.
2. Grease universal joints regularly. Check often.
3. Attach stabilizer bars to prevent side swing.
4. Replace shear bolt only with common grade #2 bolts. The use of a hard shear bolt voids all warranty.
5. Disengage PTO when moving.
6. Lift auger periodically to clear hole.
7. DO NOT LET AUGER SCREW INTO GROUND. HOLD BACK WITH HYDRAULIC LIFT SO IT DIGS. DAMAGE TO DIGGER MAY OCCUR IF NOT PROPERLY OPERATED. DO NOT MOVE TRACTOR WITH AUGER IN GROUND.

101015

ON MANUAL TUBE PLATE



ON INPUT GUARD BACKPLATE

NOTICE!
GEARBOX SHIPPED WITHOUT OIL

Fill to proper level with EP-90 gear lubricant. READ operator's manual.

101188

ON GEARBOX

SAFETY SIGNS AND DECALS (continued)



**Know what's below.
Call before you dig.**

101358

! DANGER

**KEEP CLEAR!
ENTANGLEMENT CAN
CAUSE SERIOUS BODILY
INJURY OR DEATH.**



! OPERATOR MUST ALWAYS STAY ON TRACTOR SEAT.
 ! NEVER OPERATE IF ANYONE IS WITHIN TWENTY-FIVE (25) FEET OF AUGER.
 ! NEVER REPLACE SHEARBOLT OR AUGER ATTACHING BOLTS WITH LONGER BOLT.
 ! NEVER ATTEMPT TO HANG ON THE DIGGER TO FORCE IT INTO GROUND-SEVERE INJURY OR DEATH COULD OCCUR.

101032

! WARNING

Cancer and Reproductive Harm
www.P65Warnings.ca.gov

101491

ALL THREE OF ABOVE LOCATED ON POST HOLE DIGGER BOOM

! DANGER ! DANGER ! DANGER

	<p>Rotating Parts Hazard Keep Away</p> <p><i>To Prevent Serious Injury or Death from Rotating Parts: Si no entiende ingles, se prefiere que busque a alguien que interprete las instrucciones para usted.</i></p> <ul style="list-style-type: none"> Read and understand owner's manual before operating. Do not operate without all shields and guards in place. Do not use body weight to force the auger into the ground or to locate auger point when auger is turning. Keep away from auger, cutting head and driveline when engine is running. Never replace shearbolt or auger attaching bolts with longer bolt. 	 <p style="text-align: right; font-size: x-small;">WS101130</p>
---	---	--

LOCATED ON POST HOLE DIGGER BOOM

! DANGER

<p>GUARD MISSING When this is visible DO NOT OPERATE</p>		<p>KEEP CLEAR! Keep Others Away! ENTANGLEMENT HAZARD <i>can cause Serious Injury or Death</i></p>
--	---	---

Si no entiende ingles, se prefiere que busque a alguien que interprete las instrucciones para usted.

- Never manually position the auger or manually force the auger into ground.
- This machine is designed to be operated **ONLY** from the tractor seat.
- Keep everyone clear of all moving parts of the digger while in operation.

WS101131

LOCATED AT TOP OF AUGER CENTER TUBE

REMEMBER: If Safety Signs have been damaged, removed, become illegible or parts replaced without Signs, new Safety Signs must be applied. New Safety Signs are available from your authorized dealer or factory.

INSTRUCTIONS

TRACTOR REQUIREMENTS AND PREPARATION

The Model 2403 3-pt. mounted post hole digger will fit most Category I and Category II tractors equipped with a standard 3-pt. hitch. The Model 2403 Digger will handle up to 24 inch diameter augers.

The Model 2403 post hole digger is designed for use with tractors up to 60 hp. The tractor must have a Power Take Off (PTO) rated for 540 rpm and with a 6-spline, 1³/₈" diameter output shaft.

An optional hydraulic down-pressure kit is available to provide an additional 350-450 lbs. of down-pressure in tough digging conditions.

Check the tractor's 3-pt. hydraulic lift system. It should operate up and down smoothly and have enough power to lift the dirt-loaded auger out of the hole. Refer to your tractor operator's manual or dealer for any adjustments necessary to put the 3-pt. hydraulic lift system in good working order.



WARNING

Power unit must be equipped with ROPS or ROPS cab and seat belt. Keep seat belt securely fastened. Falling off power unit can result in death from being run over or crushed. Keep foldable ROPS systems in "locked up" position at all times.

Check the shield over the PTO stub shaft. Make sure it is in good condition and bolted securely to the tractor. Purchase a new shield if old shield is damaged or missing.

Tractor must be equipped with stabilizer bars, adjustable sway chains, or sway blocks to keep the post hole digger from swinging side to side.

This product is designed to dig holes in the soil when attached to the 3-point hitch and power-take-off of a tractor. It is **not** intended for any other use. Using the product for anything other than digging holes could result in serious injury or death.

ASSEMBLY AND MOUNTING

Refer to the "exploded view" of the post hole digger on page 24 of this manual. Become familiar with the relationship of the various components and parts shown.

Unpack all the bundles and lay out various parts. Start with the yoke (Ref. #2). Place the pull pins (Ref. #17) through the holes in the legs of the yoke and secure with nuts and lock washers.

NOTE: For Category I and II tractors, place the pull pins on the outside of the yoke legs as shown in the diagram. For smaller tractors, it may work better to place the pull pins on the inner side of the yoke legs.

The pins are Category I (7/8" dia.). If your tractor is Category II, then lift arm bushings are required to properly fit the 1¹/₈" dia. Cat. II lift arm balls. (Bushings not supplied.) Place the lift arms of your tractor over the pull pins in the yoke and secure with linchpins (not supplied).

NOTE: Always use adapter bushings when using Category I pins on a Category II hitch. Trying to use Cat. I pins in a Cat. II hitch without bushings will result in a very loose fit and the post hole digger will be unstable.

Pin end of digger boom (Ref. #1) to tractor toplink bracket. Raise boom by hand – check that it doesn't hit any part of toplink bracket (some tractors only). If problem exists, change hole location and re-check. **Failure to check can result in damage to tractor or boom.** Cat. I tractors need toplink bushing. Connect yoke to boom with pin (Ref. #15) and cotter pins.

Install the plastic manual holder on the bottom of the flat plate welded to the yoke. Locate the manual holder with the cap facing away from the post hole digger. Use the two 1/4" x 1" bolts to mount the manual holder.

It is recommended that the pair of gearbox output guards, and the gearbox input guard be assembled on the gearbox before the gearbox is fastened to the boom. Place the gearbox upside down on the floor.

Install the formed metal gearbox output shields (Ref. #6) on the gearbox. A socket with a long extension makes this an easy installation. Use the 3/8" x 3/4" bolts and 3/8" flat washers to fasten the guards.

Clean and check the input shaft of the gearbox. If any nicks or dents have occurred in shipping, lightly file to remove and make the shaft smooth.

Install the input guard backplate (Ref. #7) on the front input end of the gearbox using the four bolts in the gearbox.

Attach the gearbox (Ref. #3) to the boom using the gearbox hanger pin (Ref. #25) and secure it with the two cotter pins (Ref. #26).

INSTRUCTIONS (continued)

GEARBOX OIL FILL

NOTE: The gearbox is shipped WITHOUT lubricant, so it will be necessary to fill before use. With the gearbox in a level position, fill to the side inspection hole with a good 90 wt. gear lubricant. Gearbox holds 168 fluid oz. Check often and add lubricant if necessary.

DRIVELINE ATTACHMENT

The driveline yoke and tractor PTO shaft must be dirt free and greased for attachment.

Figure A

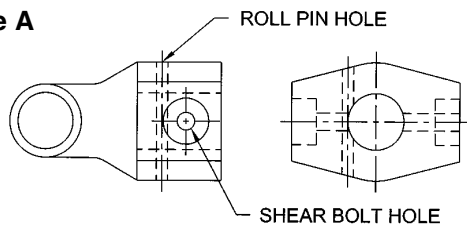

On the implement end of the PTO shaft there is a hole in the yoke just forward of the $\frac{3}{8}$ " shear bolt (see Figure A). This hole is for the $\frac{1}{4}$ " diameter x $2\frac{1}{4}$ " long roll pin (Ref. #21). When this roll pin is driven in this hole, the center of the roll pin engages into the groove on the front of the gearbox input shaft. This prevents the PTO assembly from coming off if the $\frac{3}{8}$ " shear bolt should shear.

Carefully start the $\frac{1}{4}$ " (Ref. #21) roll pin into the hole. At this time, only tap the roll pin about $\frac{1}{4}$ " into the hole. **DO NOT** tap the roll pin far enough into the hole so that it enters the 1.25" diameter shaft hole. If the roll pin is installed too far, you will not be able to install the PTO driveline on the input shaft of the gearbox. (Pre-starting the roll pin now is much easier than trying to put the roll pin in when the driveline end is on the gearbox input shaft.)

Grease the input shaft of the gearbox before installing the PTO shaft. This reduces the chance of the PTO shaft yoke from galling to the input shaft if the shear bolt should break.

Slip the two telescoping ends of the PTO shaft together. Spray WD-40 into the yoke and wipe. This should remove some of the paint and make it easier to slide the yoke onto the input shaft of the gearbox. Install the unsplined end on the gearbox input shaft and bolt it in place with the $\frac{3}{8}$ " x 3" shear bolt (Grade 2) (Ref. #18) and secure with the lock washer and nut.

Now, using a drift punch, tap the $\frac{1}{4}$ " roll pin all the way into the hole.

WARNING

Do not install a longer shear bolt or other longer fastener! A protruding fastener is more likely to grab loose clothing and can cause serious injury or death.

To connect the implement driveline to the tractor PTO output shaft, pull the driveline yoke collar back and align the grooves and splines of the yoke with those of the PTO shaft. Push the driveline yoke onto the PTO shaft, release the locking collar, and position the yoke until the locking collar balls are seated onto the PTO shaft. Push and pull the driveline back and forth several times to ensure a secure attachment.

WARNING

Before operating the Implement, check to make sure the Implement input driveline will not bottom out or become disengaged. Bottoming out occurs when the inner shaft penetrates the outer housing until the assembly becomes solid, it can shorten no more. Bottoming out can cause serious damage to the Tractor PTO by pushing the PTO into the Tractor and through the support bearings or downward onto the PTO shaft, breaking it off. A broken driveline can cause personal injury.

Slowly raise and lower the digger **without** the auger on. Watch to see that the PTO driveline and/or shields do not separate or get into a bind. Check to see if gearbox end will lower to the ground. If it will not go all the way down, then check to see if the PTO shaft is bottoming.

NOTE: Do NOT use any PTO extension adapter between tractor PTO and digger driveline.

When fitting the unit to the tractor, the telescoping driveline must be inspected to ensure that at its most compressed position, the profiles do not "bottom out", and when at its farthest extended position, there is sufficient engagement between the profiles to operate safely. At its shortest length, there must be at least a 1" clearance between each profile end and opposite profile universal joint. At its farthest operating extension, a minimum profile engagement of 6" must be maintained. If driveline has less than 6" overlap, do not use. Contact your dealer.

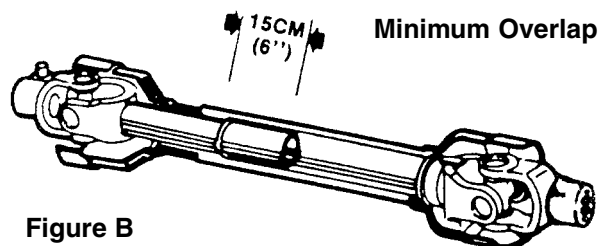

Figure B

INSTRUCTIONS (continued)

With the PTO driveline installed, place the input guard (Ref. #9) on the input guard back plate (Ref. #7) and fasten with the two threaded knobs (Ref. #9).

NOTE: The input guard back and input guard are chained together. This will keep the input guard from being mis-placed and make it more likely to be properly installed.

Install the Slow Moving Vehicle (SMV) bracket on the rear top of the gearbox. This requires removing the center rear bolt of the top cap of the gearbox. Place the bracket in position and re-install the bolt.

Place the SMV sign on the rear of the bracket and fasten with the two #10 - 24 x 1/2" screws and nuts (Ref. #38 and #39).



WARNING

When attaching PTO yoke to tractor PTO shaft, it is important that spring-activated locking pin or balls operate freely and are seated in groove on PTO shaft. A loose shaft could slip off and result in personal injury or damage to equipment.

NOTE: Use stabilizer bars, adjustable sway chains, or sway blocks on your tractor lift arms to keep the post hole digger from swinging side to side. Adjust as tightly as practical for best performance.

Slide the auger over the 2" output shaft of the gearbox and secure it with the two bolts. Use a socket wrench with an extension to tighten the auger retaining bolts. The oval shaped holes in the sides of the two piece output shaft guard will align with the auger bolts.

NOTE: Please refer to the drawings (page 25, Figures B through D) as to the proper mounting pattern for the cutting edges. Correct mounting of the cutting edges will assure a complete cut of earth by the auger.

PREPARATION PROCEDURE

- Thoroughly read and understand your Operator's Manuals.
- Before beginning operation, clear area of objects that wrap around the auger or might be thrown. Contact local utility company (call 811) to make certain there are no buried gas lines, electrical cables, etc., in the work area. Check for ditches, stumps, holes, or other obstacles that could cause the tractor to roll over.
- Layout and mark where you want to dig your holes.
- ALL persons should be at least twenty-five (25') away. Clear the area of helpers, bystanders, especially children. Do not allow anyone to stand behind, or to the side of a rotating auger.
- To dig properly, your digger must be able to raise or lower through the highest and lowest points of your lift arm travel without binding against the tractor frame. Check carefully **BEFORE** attaching the auger. If it does bind, adjust the tractor 3 pt. linkage so that all movement is free.

NOTE: On some tractors it may be necessary to remove the drawbar or slide it to one side. This will prevent the PTO driveline shaft from coming in contact with the drawbar.



CAUTION

Operate the post hole digger only on a tractor with 540 RPM PTO shaft. The tractor's engine speed should not exceed 1200 RPM while digging.

Do not operate the post hole digger near existing fence wire. Fencing wire, loose wire, cable, landscape webbing or other similar debris can become entangled in the auger and be rapidly pulled into the auger along with bystanders in contact with the material. This can result in serious injury or death. Inspect the area before digging and remove any items that could become entangled in the auger. Keep all bystanders 25 feet away from the auger and any wire of fencing material near the auger.

If you have ANY questions, regarding the proper operation of this digger, contact your dealer or the manufacturer.

OPERATING INSTRUCTIONS

PRE-OPERATION CHECKLIST

(OPERATOR RESPONSIBILITY)

- _____ Review and follow safety rules and safety signs on pages 5 through 14.
- _____ Check that post hole digger is properly and securely attached to tractor.
- _____ Make sure driveline spring-activated locking pin or locking balls operate freely and are seated firmly in tractor PTO spline groove.
- _____ Lubricate all grease fitting locations. Make sure PTO driveline slip joint is lubricated.
- _____ Check to be sure gear lube runs out the small check plug on side of gearbox.
- _____ Check that all hardware is properly installed.
- _____ Check to ensure cutting edges are sharp, secure and positioned correctly.
- _____ Check that all shields and guards are properly installed and in good condition.
- _____ Set tractor PTO gear select lever for 540 rpm operation.
- _____ DO NOT operate the unit if the pre-operation inspection reveals any condition affecting safe operation.

OPERATION

This Post Hole Digger was designed for one-man operation from the tractor seat. **It is the responsibility of the operator to see that no one else is within twenty-five feet (25') of the digger when it is operating.**

- Set tractor brakes. Take tractor out of gear. Shift to “Park” (if applicable).
- Do not allow anyone to stand behind, or to the side of a rotating auger.
- Lower auger point slowly to the ground with the PTO disengaged.
- With the auger point lowered to the ground, set the engine speed to idle, then engage the PTO. Make sure the auger point is on the ground before engaging the PTO.
- Increase the speed as required so dirt is conveyed from the hole. Most hole digging is generally best with the tractor at no more than half throttle speed (PTO speed @ approx. 300 rpm).
- Under no circumstances should the PTO be run in excess of 540 rpm.

- In some types of soil, it may be necessary to hold back against the auger screw action by moving the hydraulic control lever to “HOLD” or “RAISE” position to keep the auger from screwing into the ground.
- **NEVER use body weight to help the auger penetrate the ground.** When the ground is too tough to penetrate with your cutting edges and point, sharpen or replace them and try again. These are replaceable parts and must be in good condition to penetrate. (Optional Hydraulic Downpressure Kit is available – order #50072112.)
- If you have difficulty penetrating hard ground, refer to Owner’s Manual Trouble-shooting section for suggestions.
- When the auger has been lowered about a foot or so into the ground, raise the auger almost out of the hole to clear the dirt, then drill deeper and raise the auger again. Repeat this procedure until the desired hole depth is reached.
- **NEVER** allow anyone to shovel dirt away from a rotating auger as the shovel can be caught and thrown by the auger.
- Disengage the power-take-off when traveling between holes.

IT IS ESSENTIAL THAT EVERYONE INVOLVED IN THE ASSEMBLY, OPERATION, TRANSPORT, MAINTENANCE, AND STORAGE OF THIS EQUIPMENT BE AWARE, CONCERNED, PRUDENT, AND PROPERLY TRAINED IN SAFETY.

The post hole digger auger is free-swinging, and care should be taken while transporting the machine. **DO NOT** transport the post hole digger while the PTO is engaged as this could cause the universal joints of the PTO driveline into a sharp operating angle and cause failure of the driveline.

DIGGING A HOLE: Position the tractor so that the auger point is placed where the hole is to be. Lower the auger so that the point touches the ground. The point of the auger should be approximately 3” back of center of the gearbox. As the auger works into the ground, this slight angle will straighten, due to the pivoting action of the boom downward. If the auger has a side tilt, correct with the lift arm adjustment on the tractor hitch.

If the auger tilts too far forward or to the rear, it may be necessary to move the tractor slightly. Be careful not to bend the auger.

OPERATION INSTRUCTIONS (continued)



WARNING

- Never locate auger by putting hands on auger, gearbox, or boom when there is any sign of rotation on the driveline or auger or if the tractor is running.
- Remain on the tractor seat while operating the post hole digger. Assisting the machine by hand can result in possible injury or death.
- Never use body weight to help the auger penetrate the ground.

Engage the tractor PTO with the engine at idle (or below 1000 engine RPM). As the auger penetrates the ground, lower the unit slowly with the 3 pt. hydraulic system. **DO NOT LET THE AUGER SCREW ITSELF INTO THE GROUND!** Auger must dig with the dirt breaking up and being carried to the top by the auger flighting.

Once the hole is dug to the desired depth raise the auger while rotating to bring the dirt out of the hole. To get a clean hole, it is sometimes best to lower the auger into the hole with the auger turning and then, when at the bottom, stop the rotation and raise the auger while not turning. This brings the dirt up with little left in the hole.

For best results, allow the digger to dig about half the required depth, then lift it partially out of the hole to remove dirt and then re-enter hole and finish to the desired depth.

DO NOT LET THE DIGGER DIG SO DEEP THAT THE PTO SHAFT IS RUNNING IN THE DIRT. If hole needs to be deeper, use an auger extension. (Part #50072107)

Once the hole is completed, disengage PTO, raise auger to a safe height, release park brake and pull ahead to the next hole location with tractor.

Never raise point of the auger over 8" off the ground with PTO operating.



CAUTION

Do not shovel dirt away from a turning auger, as the shovel can be caught by the auger and thrown. Do not allow anyone to stand behind or to the side of an operating auger. ALL persons should be at least 25 feet away.

NOTE: Be sure auger is completely retracted from the hole before attempting to move the tractor.

Once the auger is digging a hole, the **tractor cannot be moved.** Make sure brake is set securely. If the tractor does move while the auger is in a hole, **damage to the gearbox or auger can result (not covered by warranty).**

Before dismounting tractor, you must always set park brake, lower the three-point attachment to the ground, turn off tractor and remove ignition key.

Underground utilities – Contact appropriate agencies to determine if hazardous items are buried under the digging site BEFORE DIGGING! Be certain underground utilities have been called to locate underground electric, gas, telephone, and other lines. Call 811 or 1-800-258-0808. Be sure post hole digger operator is properly informed. WHEN IN DOUBT, DO NOT DIG!

Cutting edges and fishtail type center points are replaceable. They should be sharpened or replaced when worn. In hard digging conditions, a fishtail type center point is more aggressive.

NOTE: If you have a rocky or large root soil condition, it is recommended that a heavy duty auger be used.

If you encounter rocks or roots that catch the auger and cause shear bolts to break, then remove the auger from the hole and use a large, heavy pry bar to break up the obstructing rock. A large root may have to be chopped to remove.



DANGER

Do not attempt to free the auger by hand while the PTO is connected. Disconnect the PTO driveline from the tractor before attempting to free the auger.

If auger becomes lodged below ground, **DO NOT** attempt to lift auger out of ground by hydraulic lift power alone. Turn tractor off and disconnect PTO driveline from the tractor. Reverse the rotation of the auger by several turns. This can be accomplished by using a large pipe wrench and turning the auger backwards until it clears. Extreme rocking or lifting loads while trying to clear stuck augers can cause auger, gearbox, or boom failure.

OPERATION INSTRUCTIONS (continued)

NOTE: Be careful when raising the auger as high as your tractor's 3 pt. hitch can go. This can put the PTO shaft universal joints at an extreme angle and cause damage to the PTO shaft! It is best to raise the auger just enough to clear the hole when the PTO is engaged.

It is recommended NOT to raise the auger while PTO is running more than eight (8) inches above the ground.

NOTE: Never exceed the recommended auger capacity of the post hole digger. The Model 2403 standard duty digger is designed for use with augers up to 24-inch diameter. Use of an incorrect auger or auger extension can cause equipment damage, loss of operator control and personal injury.

TRANSPORTING

Pay particular close attention to the Safety Messages regarding transport. Avoid unnecessary injuries and equipment damage by exercising cautious, conscientious travel procedures.

Read all safety warnings in the front of the manual.

Attaching the implement to the tractor increases the overall length of the working unit. Allow additional clearance for the implement to swing when turning.



CAUTION

When traveling on public roads, whether at night or during the day, use accessory light and devices for adequate warnings to operators of other vehicles. Comply with all federal, state and local laws.

DO NOT OPERATE PTO DURING TRANSPORT.

Raise the post hole digger as high as possible for transporting.



WARNING

Be aware of the operating conditions. Do not operate the tractor with weak or faulty brakes. When operating down a hill or on wet or rain slick roads, the braking distance increases; use extreme care and reduce your speed in these conditions. When operating in traffic, always use the tractor's flashing warning lights and reduce your speed.

Transport to and from your digging site at a safe speed and in such a manner that faster moving vehicles may pass safely. A slow moving vehicle sign should always be properly displayed when using a public road or right-of way.

REMOVING DIGGER FROM TRACTOR

Post hole diggers when off the tractor, can be an awkward piece of equipment to handle.

Always shut the tractor completely down, place the transmission in park, disengage the PTO and set the parking brake before you or anyone else attempts to connect or disconnect the implement.

Storage location should be level and solid to make connecting and disconnecting easy. Store in a clean, dry location away from children and livestock. Keep the driveline yoke from sitting in dirt or water.

Use extreme care to keep feet and hands from under the unit and clear of any pinch points. Never stand or allow another person to stand between a running tractor and the unit when disconnecting the implement from the 3-point hitch.

The optional parking stand may be used when Post Hole Digger is not in operation. The parking stand aids in mounting and dismounting the Post Hole Digger to and from the tractor.

POST HOLE DIGGER OPTIONS

- 1. Heavy Duty Augers:** For rocky or tough soil conditions. Check with dealer for availability.
- 2. 12" Auger Extension:** Available for situations where deeper holes are required. **NOTE:** Smaller tractors may not raise auger high enough to clear hole when 12" auger extension is used. Order part #50072107.
- 3. Hydraulic Down Force Kit:** For tough, hard soil conditions. This will allow operator to put 300-400 lbs. of down force on the auger for tough or hard ground. Tractor must have auxiliary hydraulic outlet. Order part #50072112 for Model 2403 Post Hole Diggers. (See page 26).
- 4. Parking Stand Kit:** Kit allows the post hole digger to be stored in an upright position. Makes connecting and disconnecting from tractor an easy one man operation. Order part #50072111. (See page 27).

OWNER SERVICE

The information in this section is written for operators who possess basic mechanical skills. Should you need help, your dealer has trained service technicians available. For your protection, read and follow all safety information in this manual.

WARNING

- ▲ Lower post hole digger to ground or block securely, turn tractor engine off, remove key and disconnect PTO driveline from tractor PTO before performing any service or maintenance.
- ▲ Before working underneath, raise 3 pt. hitch to desired position and block securely. Hydraulic system leakdown and failure of mechanical or hydraulic system can cause equipment to drop.
- ▲ Keep all persons away from operator control area while performing adjustments, service or maintenance.

ROUTINE MAINTENANCE

DAILY CHECKS:

1. Check that all bolts, nuts, and screws are tight. Checking the bolts and nuts on the cutting blades is particularly important in rocky soil.
2. Check daily the level of the gearbox oil and top up to the correct level. Check for gearbox oil leaks. It should be noted that no warranty claim can be submitted on a gearbox that has run dry. It is essential that the gearbox is kept correctly filled with gearbox oil.
3. Grease the PTO shaft daily.
4. Check the wear on the cutting blades. Sharpen them routinely with an angle grinder or replace when worn down too far. Keep at least two sets of cutting blades, bolts, and nuts as spares.

LUBRICATION INFORMATION

The accompanying chart gives the frequency of lubrication in operating hours, based on normal conditions. Severe or unusual conditions may require more frequent lubrication.

Do not let excess grease collect on or around parts, particularly when operating in sandy areas.

Use an SAE 90W gear lube in gearbox.

Use a lithium grease of NO. 2 consistency with a MOLY (molybdenum disulfide) additive for all locations. Be sure to clean fittings thoroughly before attaching grease gun. When applied according to the lubrication chart, one good pump of most guns is sufficient. Do not over grease.

LUBRICATION CHART

REF NO.	DESCRIPTION	FREQUENCY
1	Front U-Joint	8 Hrs.
2	Rear U-Joint	8 Hrs.
3	Rear PTO yoke on gearbox input shaft	8 Hrs.
4	Gearbox – Fill to proper level <i>(Gearbox holds 168 fluid oz.)</i>	Check Daily

NOTE: Grease the rear PTO driveline yoke on the input shaft of the gearbox. This reduces the chance of the PTO yoke galling to the input shaft if the shear bolt should break. If digging conditions are breaking a number of shear bolts, then grease this location more often.

BEFORE EACH USE:

- A. Driveline Universal Joints – Apply multi-purpose grease to fittings.
- B. Driveline Guard – Apply 2-3 shots of multi-purpose grease to plastic fittings.
- C. Driveline Shaft – Disconnect PTO driveline, pull two sections apart, and apply thin coat of multi-purpose grease to inside of outer (female) section. Reassemble sections and install. Pull each section to be sure driveline and shields are securely connected. Make certain PTO shielding is in good condition.

AT THE END OF THE SEASON:

1. Drain and change the oil in your gearbox.
2. Check and replace, where necessary, blades, bolts, nuts on the machine.
3. Clean machine and touch up any rust spots that may have appeared.
4. Replace any safety signs if damaged or painted over.
5. Make sure PTO driveline yoke and gearbox input shaft are clean and free of burrs. Keep well lubricated to prevent galling of yoke and input shaft when shear bolt becomes sheared.
6. Keep all shields in place. Order new shields if damaged or missing.
7. Keep cutting edges sharp. Sharp cutting edges dig easier and better. Outer cutting edges on larger augers wear faster than inner cutting edges; switching teeth will even wear.
8. Store implement in clean, dry location, away from children, animals, or traffic area.

TROUBLE-SHOOTING GUIDE

PROBLEM	POSSIBLE CAUSE	POSSIBLE REMEDY
Auger will not dig.	1. Shear bolt sheared.	Install new Grade 2 shear bolt.
	2. Teeth dull.	Sharpen or replace teeth.
	3. Ground too dry and hard.	Order optional down force kit, or wait until it rains. (May have to replace center point.)
	4. Auger turning too fast and bouncing.	Reduce speed.
	5. Tall grass has wrapped around auger teeth.	Remove grass.
	6. Auger encountering rocks, roots, or other obstruction.	Lift auger from hole and remove obstruction or change location.
	7. Auger teeth improperly positioned.	See operator's manual for proper tooth pattern. (Page 25)
Auger digs so far, but will not dig deeper.	1. PTO driveline assembly "bottoms out" and does not allow auger to lower any further.	Remove auger from digger and lower digger for inspection. Gearbox should lower to the ground; if not, PTO driveline assembly may need to be shortened. Maintain minimum 6" overlap of driveline tubes.
	2. Soil could have hardpan layer below surface.	Use optional Down Pressure Kit to assist pushing auger into the ground.
	3. PTO driveline interferes with swinging drawbar.	Swing drawbar out of the way or remove.
Post hole digger sways side to side.	1. No sway bars or sway blocks on tractor.	Add stabilizers to lower 3-point lift arms.
	2. Lift arms not adjusted evenly.	Adjust lift arms to be level with each other.
	3. Post hole digger is mounted with excessive looseness in the hitch connecting points.	Use proper size pins or bushings.
Auger is bent and/or auger flighting is bent.	1. Tractor moved on its own while auger was turning in the hole.	Always make sure gear selector is in neutral or park and brakes are set.
	2. Operator moved tractor excessively with auger in hole to try to straighten hole being dug at an angle.	Be careful not to damage gearbox or auger when moving tractor. While digging, move tractor in very small increments to keep the hole straight.
	3. Auger is encountering rocks, roots or other obstructions.	Lift auger from hole and remove obstruction or change location. Use H.D. Auger.
	4. Shear bolt has been replaced with a harder bolt.	Replace with Grade 2 bolt per instructions.
Auger screws itself into the ground.	1. Operator did not lower 3-point hitch to the ground slowly.	Lower 3-point hitch slowly to ground.
	2. Faulty tractor hydraulics for the 3-point hitch.	Repair hydraulic for the 3-point hitch.
	3. Tractor is too small to handle the post hole digger.	Mount post hole digger on a larger tractor.
Driveline comes off input shaft of gearbox.	1. Shear bolt is broken and roll pin is missing in driveline yoke at the gearbox input shaft.	Replace shear bolt and roll pin.

TROUBLE-SHOOTING GUIDE (continued)

PROBLEM	POSSIBLE CAUSE	POSSIBLE REMEDY
Driveline is damaged.	1. Raising auger too high with PTO engaged causing excessive joint operating angle.	Stop driveline rotation before raising auger too high.
	2. Auger swings while moving from hole to hole with PTO engaged causing excessive PTO joint operating angle.	Always disengage PTO before moving tractor.
	3. Having to raise the auger with an extension too high in order to remove it from the hole causing excessive joint operating angle.	Stop driveline rotation while auger is still in the hole and before the Post Hole Digger is high enough to cause drive line damage.
	4. Shear bolt has been replaced with a harder bolt.	Use Grade 2 bolt per instructions.
	5. Driveline has not been properly lubricated.	Lubricate driveline per instructions.
	6. PTO was engaged while tractor engine was running at high RPM.	Slow engine down to an idle before engaging PTO.
	7. Driveline contacts ground before hole is completely dug.	Pin boom to yoke per "Depth Adjustment" instructions. May Need to use an auger extension.
	8. Operating PTO at high RPM.	Never Run PTO above 300 RPM.
	9. Tractor is a "low profile model" (one that is low to the ground). Due to the low height of the tractor, the digger must be raised higher to have the bottom of the auger clear the ground.	Generally, low profile model tractors can only use 30 inch long augers (standard auger length is 42"). Use a different tractor or purchase 30" long augers.
Tractor stalls.	1. Auger is encountering rocks or roots or other foreign object.	Remove object or change hole location.
	2. Tractor idle is not set correctly.	Tune tractor engine.
PTO driveline "galls" or "friction welds" to input shaft of gearbox.	1. No lubrication on input shaft of gearbox to allow yoke of PTO driveline to turn freely on input shaft when shear bolt is sheared.	Always keep input shaft greased. Implement end yoke and gearbox input pinion may have to be replaced.
	1. Shear bolt on input shaft has been replaced with a harder bolt	Replace with Grade 2 bolt as per instructions.
Gearbox failure.	1. No oil in gearbox.	Add oil and check per instructions.
	2. Oil not changed per instructions.	Change oil.
	3. Shear bolt has been replaced with a harder bolt.	Replace with Grade 2 bolt per instructions.
	4. Bent output shaft is due to operator moving tractor when auger is in hole.	Retrain operator.
Gearbox overheating.	1. Low on lubricant.	Fill to proper level.
	2. Improper type lubricant.	Replace with proper lubricant.
Excessive vibration.	1. PTO driveline bearing cross is worn.	Replace bearing cross assembly.

MODEL 2403 POST HOLE DIGGER ILLUSTRATION

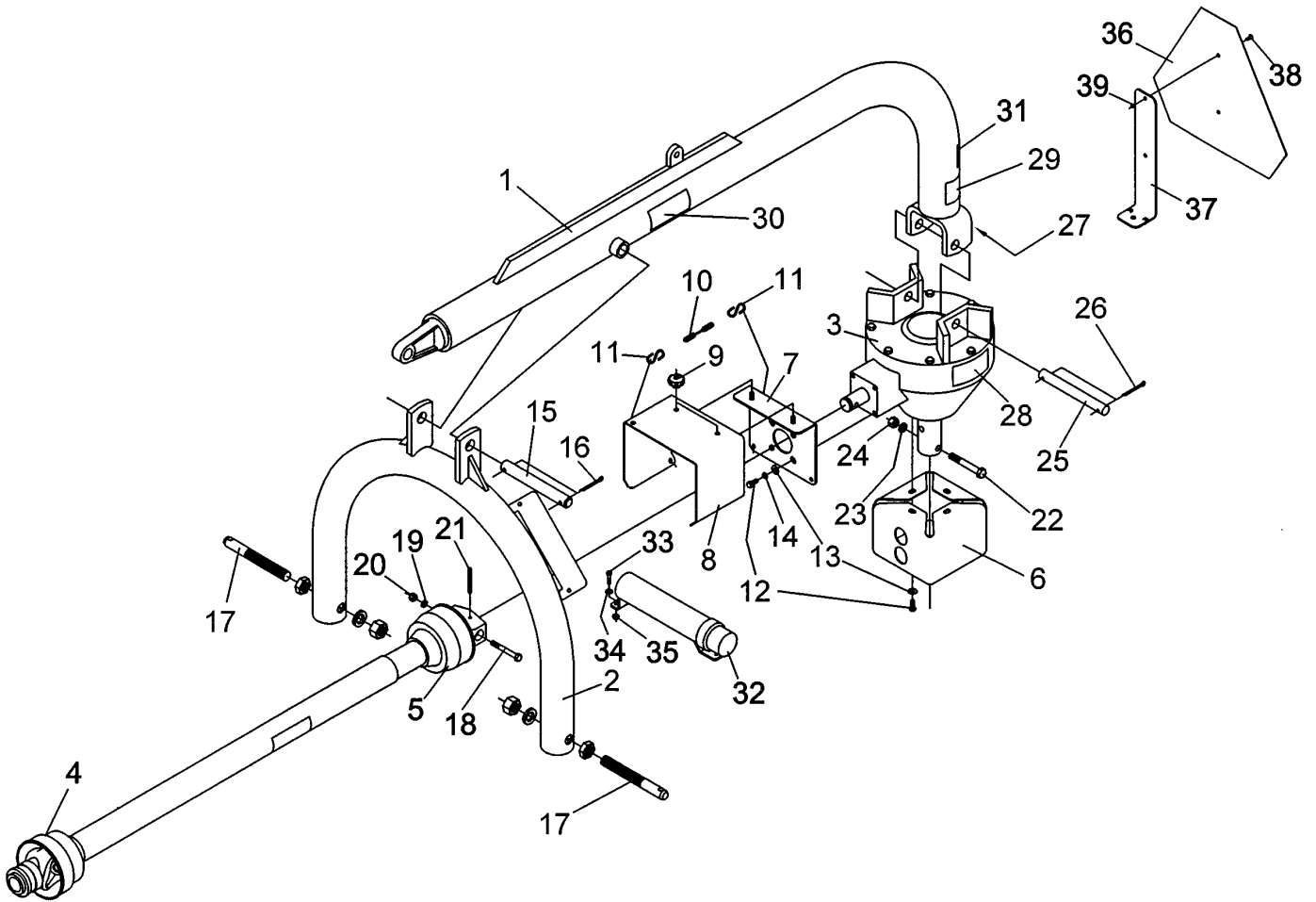

AUGER PARTS ILLUSTRATION

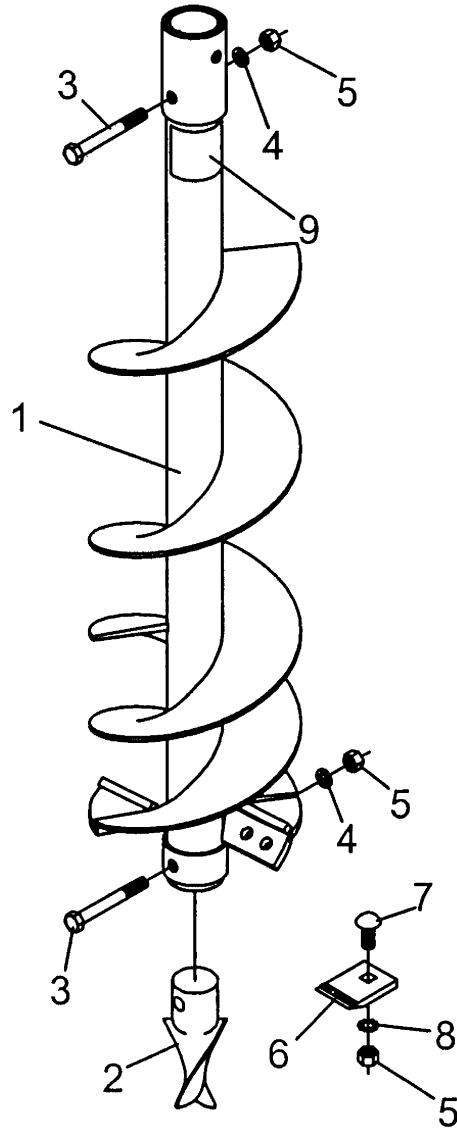

AUGER TEETH MOUNTING PATTERNS (Regular Duty Augers)



FIG.
B
6"

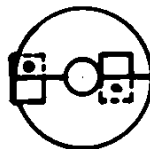

FIG.
C
9"

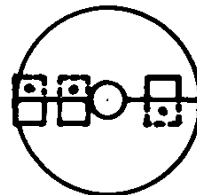

FIG.
D
12"

DOWN FORCE KIT INSTRUCTIONS

KIT #50072112 (FOR MODEL 2403 POST HOLE DIGGER)

INSTALLATION

1. Refer to the parts illustration and install the Down Force Kit parts as shown. Remove the boom lift pin that connects yoke assembly to the post hole digger boom.
2. Place pivot plates (1) on inside of yoke assembly and replace boom lift pin. Secure with cotter pin previously removed.
3. Install bolt (2), spacer (4), and lock nut (3) in middle hole.
4. Install second bolt (2), two spacer sleeves (5), base end of cylinder (6), and lock nut (3) in top hole.
5. With cylinder retracted, attach cylinder to lug on top of boom with $\frac{1}{2}$ " x 2" bolt (7) and nut (8).
6. Install pressure hose (10) to top port on the relief valve. Attach male coupler (not supplied) to other end of hose (10) and connect to tractor remote outlet.
7. Attach adapter (13) and return hose (11) to side port on the relief valve. Connect return hose directly to tractor hydraulic reservoir.

NOTE: DO NOT CONNECT THE RETURN HOSE TO A REMOTE OUTLET. Remote outlet ports are blocked in the neutral position and will damage the hydraulic cylinder or other parts when boom is raised.

OPERATION

Lower the Post Hole Digger in the usual manner and allow the auger to dig. As down force is needed, apply it carefully and in small amounts by using the control lever on the tractor remote outlet. It will be necessary to continue lowering the lift arms as the auger digs. Applying too much down force at one time can stall the auger and possibly cause the shear bolt on the post hole digger input shaft to shear. **NOTE: REPLACE THE SHEAR BOLT WITH A GRADE #2 (SOFT) BOLT ONLY.** Using a (HARD) bolt can damage the auger, PTO driveline or gearbox and void the warranty.

The boom can be raised in the normal manner without relieving the down force cylinder pressure. Hydraulic cylinder will retract.

NOTE: DAMAGE CAN OCCUR IF HOSES ARE NOT CONNECTED CORRECTLY. If the return hydraulic hose is connected to the other tractor remote outlet instead of directly to the tractor hydraulic reservoir, severe damage will possibly occur to the hydraulic cylinder and post hole digger when the boom is raised. Make sure hydraulic hoses are connected correctly.

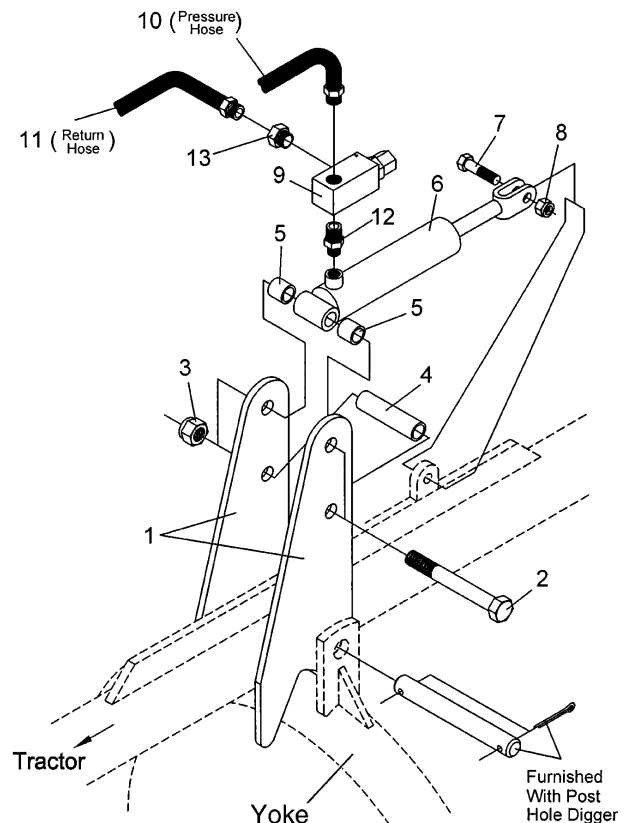

OPTIONAL PARKING STAND

KIT #50072111 (FOR MODEL 2403 POST HOLE DIGGER)

1. Remove auger from digger.
2. Remove hardware (5 & 6) and output shield (7) from bottom of gearbox.
3. Place parking stand base plate (4) and output shield (7) over the output shaft. Secure to the bottom of the gearbox using four bolts (5) and flat washers (6) previously removed.
4. Install auger to output shaft using two bolts previously removed.
5. Raise digger to the transport position.
6. Insert the two stand legs (2) into the socket on the front of the parking stand base plate. Secure with two locking pins (3).
7. Lower digger until the two legs and the auger form a tripod. This will support the post hole digger in a vertical position.
8. Remove 3 point arms and driveline from the tractor. Then disconnect the boom from tractor.
9. Attach the PTO hook (1) to the boom of the digger.
10. Hang the driveline from the hook to help prevent dirt and debris from accumulating in the locking collar on the driveline PTO yoke.

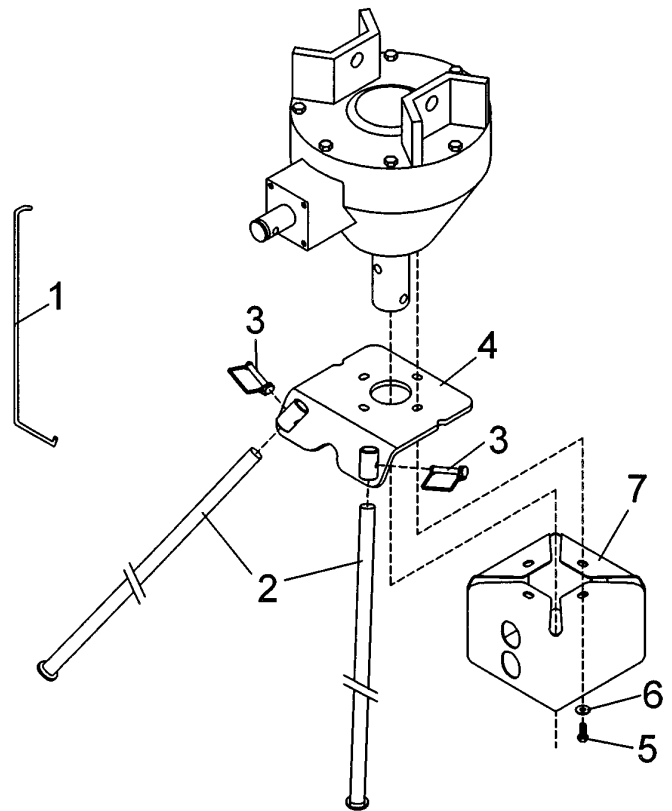

The Parking Stand Kit has a plate that bolts to the bottom of the gearbox. Two removable legs go into sockets welded on the plate. The legs are pinned in place. The two legs and the auger form a tripod which supports the post hole digger in a vertical position. A formed hook keeps the PTO driveline end off the ground.

This makes connecting or removing the post hole digger from the tractor a one man job.

Make sure the post hole digger will be located on a solid surface and in a location away from children, animals, or traffic areas.







PARKING STAND PARTS

Ref. #	Description	Qty.
1	PTO Hook	1
2	Leg Stand	2
3	Lock Pin 5/16"	2
4	Parking Stand Base Plate	1
5	5/16" NC x 3/4" Hex Head	4
6	5/16" Flat Washer	4
7	Output Shield (2 Piece)	2

PROPER TORQUE FOR FASTENERS

The charts below list the correct tightening torque for fasteners. When bolts are to be tightened or replaced, refer to the charts to determine the grade of bolt and the proper torque.

BOLT CLASSIFICATION AND IDENTIFICATION CHART

INCH		METRIC	
SAE GRADE	BOLT HEAD MARKINGS	CLASS	BOLT HEAD MARKINGS
2		5.8	
5		8.8	
8		10.9	

Recommended torque for all Standard Unplated Nuts and Bolts, provided:

- A. Surface finish is oxide coated, oil quenched or bright.
- B. All thread surfaces are clean and lubricated with SAE-30 engine oil or equivalent.
- C. Joints are rigid. That is, no gaskets or compressible materials are used.
- D. When re-using nuts or bolts, use minimum torque values.

NOTE: Multiply the standard torque by:

- .65 when finished jam nuts are used.
- .70 when Molykote, white lead or similar mixtures are used as lubricants.
- .75 when phosphate coated and oiled bolts or nuts are used.
- .85 when cadmium or zinc dichromate bolts or nuts are used.
- .90 when hardened surfaces are used under the nut or bolt head (this applies to standard unplated hardware only).



STANDARD TORQUE DATA FOR INCH NUTS AND BOLTS (Foot Pounds)

RECOMMENDED TORQUE IN FOOT POUNDS

Bolt Diameter	SAE Grade 2	SAE Grade 5	SAE Grade 8
1/4"	6	11	14
5/16"	13	21	25
3/8"	23	38	55
7/16"	37	55	80
1/2"	57	85	120
9/16"	82	125	180
5/8"	111	175	230
3/4"	200	300	440

STANDARD TORQUE DATA FOR METRIC NUTS AND BOLTS (Foot Pounds)

RECOMMENDED TORQUE IN FOOT POUNDS

Bolt Diameter	 Class 5.8		 Class 8.8		 Class 10.9	
	Min.	Max.	Min.	Max.	Min.	Max.
6	5	6	8	9	11	13
7	9	10	14	15	19	21
8	13	14	20	23	28	31
10	25	28	40	45	54	61
12	43	49	70	78	95	106
14	70	78	111	125	151	170
16	108	121	172	194	233	263
18	149	168	238	268	324	364
20	210	237	336	378	458	515
22	287	323	458	616	624	702
24	363	409	581	654	791	890

SPECIFICATIONS

MODEL 2403

Tractor Category	Category 1 and Category 2
Gearbox	Special alloy pinion gears and tapered roller bearings – 4:1 ration.
Gears	Heat-treated to Rockwell C30-40 to a depth of .030-.040
Driveline	Equipped with quick-tach yoke to fit standard 6-spine PTO (completely shielded)
Cutting Edges	Sold separately.
Center Point	Sold separately. Fishtail Type.
Auger	6", 9", or 12" Regular Duty; 6", 9", 12", 18", or 24" Heavy Duty sizes available.
Boom	3-1/2" O.D. high strength tubing with welded top reinforcing rib.
A-frame	2-7/8" high strength tubing.
Safety Shields	On driveline, gearbox "U" joint and gearbox output shaft.
Shear Bolt	Replaceable. On input shaft to protect driveline, auger and gears.
Options	Hydraulic down force kit, 12" auger extension, and parking stand.

NOTES:

TO THE OWNER/OPERATOR/DEALER

To keep your implement running efficiently and safely, read your manual thoroughly and follow these directions and the Safety Messages in this Manual. The Table of Contents clearly identifies each section where you can easily find the information you need.

The OCCUPATIONAL SAFETY AND HEALTH ACT (1928.51 Subpart C) makes these minimum safety requirements of tractor operators:

REQUIRED OF THE OWNER:

1. Provide a Roll-Over-Protective Structure that meets the requirements of this Standard; and
2. Provide Seat belts that meet the requirements of this paragraph of this Standard and SAE J4C; and
3. Ensure that each employee uses such Seat belt while the tractor is moving; and
4. Ensure that each employee tightens the Seat belt sufficiently to confine the employee to the protected area provided by the ROPS

REQUIRED OF THE OPERATOR:

1. Securely fasten seat belt if the tractor has a ROPS.
2. Where possible, avoid operating the tractor near ditches, embankments, and holes.
3. Reduce speed when turning, crossing slopes, and on rough, slick, or muddy surfaces.
4. Stay off slopes too steep for safe operation.
5. Watch where you are going - especially at row ends, on roads, and around trees.
6. Do not permit others to ride.
7. Operate the tractor smoothly - no jerky turns, starts, or stops.
8. Hitch only to the drawbar and hitch points recommended by the tractor manufacturer.
9. When the tractor is stopped, set brakes securely and use park lock, if available.

-
- x Keep children away from danger all day, every day...
 - x Equip tractors with rollover protection (ROPS) and keep all machinery guards in place...
 - x Please work, drive, play and live each day with care and concern for your safety and that of your family and fellow citizens.



BUSH HOG®

2501 Griffin Avenue • Selma, AL 36703

(334) 874-2700

www.bushhog.com