

# BUSH HOG®

# CULTIPACKERS CP SERIES

MODELS  
CP960, CP972, CP984, CP996  
CP1560, CP1572, CP1584, CP1596  
CP1660, CP1672, CP1684, CP1696

Revised: 05/22

MATERIAL HANDLING PARTS MANUAL

## PARTS MANUAL SECTION 54



An Operator's Manual was shipped with the equipment . The Operator's Manual is an integral part of the safe operation of this machine and must be maintained with the unit at all times. **READ, UNDERSTAND, and FOLLOW** the Safety and Operation Instructions contained in this manual before operating the equipment. If the Operator's Manual is not with the equipment, contact your dealer or Bush Hog to obtain a Free copy before operating the equipment.



### BUSH HOG®

2501 Griffin Ave.  
Selma, AL 36703  
Parts Ordering 1-800-304-2836  
www.bushhog.com

### ATENCIÓN!

LEA EL INSTRUCTIVO

Si No Lee Ingles, Pida Ayuda a Alguien  
Que Si Lo Lea Para Que le Traduzca las  
Medidas de Seguridad.



**MEMBER OF THE  
ALAMO GROUP**  
ALWAYS ON THE CUTTING EDGE®

© 2011 Alamo Group Inc.

## PARTS ORDERING GUIDE

The following instructions are offered to help eliminate needless delay and error in processing purchase orders for the equipment in this section.

1. The Parts Section is prepared in logical sequence and grouping of parts that belong to the basic machine featured in this manual. Part Numbers and Descriptions are given to help locate the parts and quantities required.
2. The Purchase Order must include the name and address of the person or organization ordering the parts, who should be charged, and if possible, the serial number of the machine for which the parts are ordered.
3. The Purchase Order must clearly list the quantity of each part, the complete and correct part number (be sure to include all periods), and the basic name of the part.
4. The Manufacturer reserves the right to substitute parts where applicable.
5. Some parts are unlisted items which are special production items not normally stocked and are subject to special handling. Request a quotation for such parts before sending a Purchase Order.
6. The Manufacturer reserves the right to change prices without prior notice.



For maximum safety and to guarantee optimum product reliability, always use genuine BUSH HOG Parts. The use of inferior replacement parts may cause premature or catastrophic failure which could result in serious injury or death. Direct any questions regarding parts to:

**BUSH HOG**  
**2501 Griffin Ave.**  
**Selma, AL 36703**  
**[www.bushhog.com](http://www.bushhog.com)**  
**Contact Us**  
**800-304-2836**



**BUSH HOG®**

# To the Owner/Operator/Dealer

All implements with moving parts are potentially hazardous. There is no substitute for a cautious, safe-minded operator who recognizes the potential hazards and follows reasonable safety practices. The manufacturer has designed this implement to be used with all its safety equipment properly attached to minimize the chance of accidents.

**BEFORE YOU START!** Read the safety messages on the implement and shown in your manual. Observe the rules of safety and common sense!





# DANGER

FAILING TO FOLLOW SAFETY MESSAGES AND OPERATING INSTRUCTION CAN CAUSE SERIOUS BODILY INJURY OR EVEN DEATH TO OPERATOR AND OTHERS IN THE AREA.

<p>1.</p> 	<p>2. NO RIDERS. NO CHILDREN OPERATORS</p> 	<p>3. USE SAFETY SHOES, HARD HAT, SAFETY GLASSES, SEAT BELTS, ROPS &amp; OPS.</p> 	<p>4. BLOCK UP SECURELY BEFORE WORKING UNDER.</p> 
---	--	--	---

1. Study and understand Operator's Manuals, Safety Decals, and Instructional Decals for tractor and implement to prevent misuse, abuse, and accidents. Practice before operating in a confined area or near passersby.
  - Learn how to stop engine suddenly in an emergency. Be alert for passersby and especially children.
2. Allow no children on or near folding mower or tractor. Allow no riders on tractor or implement. Falling off may cause serious injury or death from being run over by tractor or mower or contact with rotating blades.
3. Operate only with tractor having Roll-Over Protective Structure (ROPS) and with seat belt securely fastened to prevent injury and possible death from falling off or tractor overturn.
  - Personal Protective Equipment such as Hard Hat, Safety Glasses, Safety Shoes, & Ear Plugs are recommended.
4. Block up or support raised machine and all lifted components securely before putting hands or feet under or working underneath any lifted component to prevent crushing injury or death from sudden dropping or inadvertent operation of controls. Make certain area is clear before lowering or folding.
5. Before transporting, put Lift Lever in detent or full-lift position. Install Transport Safety Devices securely on folding mowers. Put Booms securely in Transport Rest.
  - Folding and Boom Mowers have raised center of gravity. Slow down when turning and on hillsides.
6. Make certain that SMV sign, warning lights, and reflectors are clearly visible. Follow local traffic codes.
7. Never operate with Cutting Head or Folding Section raised if passersby, bystanders, or traffic are in the area to reduce possibility of injury or death from objects thrown by Blades under Guards or mower structure.
8. Before dismounting, secure implement in transport position or lower to ground.
  - Put tractor in park position or set brake, disengage PTO, stop engine, remove key, and wait until noise of rotation has ceased to prevent crushing by entanglement in rotating parts which could cause injury or death.
  - Never mount or dismount a moving vehicle. Crushing from runover may cause serious injury or death.

<p>5. TRANSPORT SAFELY, LOCK UP.</p> 	<p>6. USE SMV, LIGHTS, &amp; REFLECTORS.</p> 	<p>7. DO NOT OPERATE WITH CUTTER OR WING RAISED</p> 	<p>8. DO NOT MOUNT OR DISMOUNT WHILE MOVING.</p> 
--	--	--	--

02967827

## WARRANTY INFORMATION:

Read and understand the complete Warranty Statement found in this Manual. Fill out the Warranty Registration Form in full and return it to within 30 Days. Make certain the Serial Number of the Machine is recorded on the Warranty Card and on the Warranty Form that you retain.

# LIMITED WARRANTY



Bush Hog warrants to the original purchaser of any new Bush Hog equipment, purchased from an authorized Bush Hog dealer, that the equipment be free from defects in material and workmanship for a period of one (1) year for non-commercial, state and municipalities' use and ninety (90) days for commercial use from date of retail sale. The obligation of Bush Hog to the purchaser under this warranty is limited to the repair or replacement of defective parts.

Replacement or repair parts installed in the equipment covered by this limited warranty are warranted for ninety (90) days from the date of purchase of such part or to the expiration of the applicable new equipment warranty period, whichever occurs later. Warranted parts shall be provided at no cost to the user at an authorized Bush Hog dealer during regular working hours. Bush Hog reserves the right to inspect any equipment or parts which are claimed to have been defective in material or workmanship.

## DISCLAIMER OF IMPLIED WARRANTIES & CONSEQUENTIAL DAMAGES

Bush Hog's obligation under this limited warranty, to the extent allowed by law, is in lieu of all warranties, implied or expressed, **INCLUDING IMPLIED WARRANTIES OF MERCHANTABILITY AND FITNESS FOR A PARTICULAR PURPOSE** and any liability for incidental and consequential damages with respect to the sale or use of the items warranted. Such incidental and consequential damages shall include but not be limited to: transportation charges other than normal freight charges; cost of installation other than cost approved by Bush Hog; duty; taxes; charges for normal service or adjustment; loss of crops or any other loss of income; rental of substitute equipment, expenses due to loss, damage, detention or delay in the delivery of equipment or parts resulting from acts beyond the control of Bush Hog.

### THIS LIMITED WARRANTY SHALL NOT APPLY:

1. To vendor items which carry their own warranties, such as engines, tires, and tubes.
2. If the unit has been subjected to misapplication, abuse, misuse, negligence, fire or other accident.
3. If parts not made or supplied by Bush Hog have been used in connection with the unit, if, in the sole judgement of Bush Hog such use affects its performance, stability or reliability.
4. If the unit has been altered or repaired outside of an authorized Bush Hog dealership in a manner which, in the sole judgement of Bush Hog, affects its performance, stability or reliability.
5. To normal maintenance service and normal replacement items such as gearbox lubricant, hydraulic fluid, worn blades, or to normal deterioration of such things as belts and exterior finish due to use or exposure.
6. To expendable or wear items such as teeth, chains, sprockets, belts, springs and any other items that in the company's sole judgement is a wear item.

NO EMPLOYEE OR REPRESENTATIVE OF BUSH HOG IS AUTHORIZED TO CHANGE THIS LIMITED WARRANTY IN ANY WAY OR GRANT ANY OTHER WARRANTY UNLESS SUCH CHANGE IS MADE IN WRITING AND SIGNED BY BUSH HOG'S SERVICE MANAGER, 2501 GRIFFIN AVE., SELMA, ALABAMA 36703.



Record the model number, serial number and date purchased. This information will be helpful to your dealer if parts or service are required.

MODEL NUMBER \_\_\_\_\_

SERIAL NUMBER \_\_\_\_\_

DATE OF RETAIL SALE \_\_\_\_\_

MAKE CERTAIN THE WARRANTY  
HAS BEEN FILED WITH BUSH HOG  
SELMA, ALABAMA

# INDEX

<b>ITEM</b>	<b>PAGE NUMBER</b>
CP960, CP972, CP984, CP996 Cultipachers .....	.54-1-1
CP1560, CP1572, CP1884, CP1596 Cultipackers .....	.54-1-2
CP1660, CP1672, CP1684, CP1696 Cultipackers .....	.54-1-3
Safety Decals and Marking Decals .....	.54-1-4



## CULTIPACKER

### MODELS CP960, CP972, CP984, CP996

### 3 Pt. Lift 9.5" Gray Iron Notched Wheels - 1.75" Axle

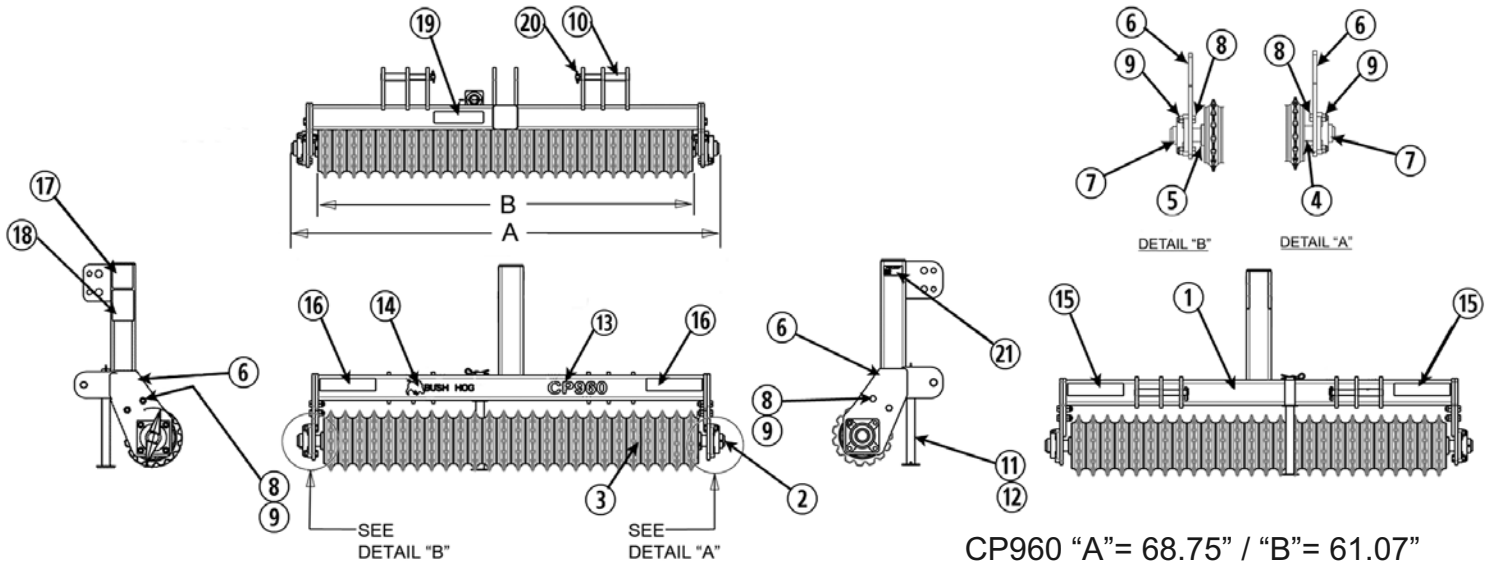

CP960 "A"= 68.75" / "B"= 61.07"  
 CP972 "A"= 81.06" / "B"= 73.28"  
 CP984 "A"= 93.38" / "B"= 85.32"  
 CP996 "A"= 105.75" / "B"= 97.70"

REF. NO.	PART NO.	DESCRIPTION	QTY.	NOTES
1	-----	Cultipacker Frame	1	Non Replaceable
2	50079012	Axle CP960	1	
	50079017	Axle CP972	1	
	50079019	Axle CP984	1	
	50079021	Axle CP996	1	
3	50078776	Wheel, 9.64" Notched/Gray Iron	A/R	26 CP960, 31 CP972, 37 CP984, 42 CP996
4	50079013	Axle Spacer CP960	1	
	50079018	Axle Spacer CP972 & CP996	1	
	50079020	Axle Spacer CP984	1	
5	50079014	Locking Collar	1	
6	50079015	Side Plate	2	
7	50078777	Bearing	2	
8	20947	Capscrew 5/8" x 2" Gr.5	12	
9	45020BH	Locknut 5/8" Nylock	12	
10	99342	Pul Pin CAT 1 & 2	2	
11	50039221	Retainer Pin	1	
12	50079016	Jackstand	1	
13	50078876	Model Decal CP960	1	
	50078878	Model Decal CP972	1	
	50078880	Model Decal CP984	1	
	50078882	Model Decal CP996	1	
14	50083387	Bush Hog Decal, 1.5" x 9.85"	1	
15	50031212	Amber Reflector	2	
16	50031214	Red Reflector	2	
17	89141	Caution Decal	1	
18	90960BH	Warning Decal	1	
19	00725746	Peligro Decal	1	
20	2850005	Lynch Pin, 7/16"	2	
21	-----	Serial No. Decal	1	Non Replaceable
22	50079010	Operators Manual	1	Not Shown

## CULTIPACKER MODELS CP1560, CP1572, CP1584, CP1596 3 Pt. Lift 15" Gray Iron Smooth Wheels - 2" Axle

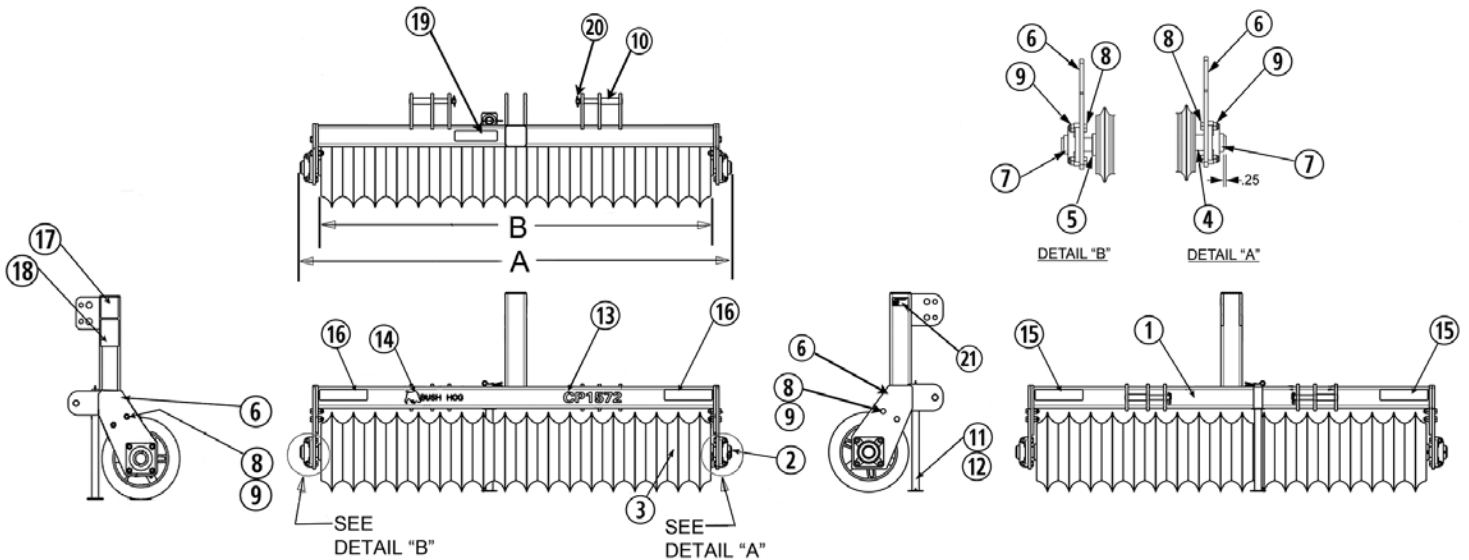

CP1560 "A"= 68.75" / "B"= 61.07"  
 CP1572 "A"= 81.06" / "B"= 73.28"  
 CP1584 "A"= 93.38" / "B"= 85.32"  
 CP1596 "A"= 105.75" / "B"= 97.70"

REF. NO.	PART NO.	DESCRIPTION	QTY.	NOTES
1	-----	Cultipacker Frame	1	Non Replaceable
2	50079022	Axle CP1560	1	
	50079029	Axle CP1572	1	
	50079030	Axle CP1584	1	
	50079031	Axle CP1596	1	
3	50079023	Wheel, 15" Smooth/Gray Iron	A/R	15 CP1560, 18 CP1572, 21 CP1584, 24 CP1596
4	50079024	Axle Spacer	1	
5	50079025	Locking Collar 2" Axle	1	
6	50079026	Side Plate	2	
7	50079027	Bearing 2"	2	
8	20947	Capscrew 5/8" x 2" Gr.5	12	
9	45020BH	Locknut 5/8" Nylock	12	
10	99342	Pull Pin CAT 1& 2	2	
11	50039221	Retainer Pin	1	
12	50079028	Jackstand	1	
13	50078884	Model Decal CP1560	1	
	50078886	Model Decal CP1572	1	
	50078888	Model Decal CP1584	1	
	50078890	Model Decal CP1596	1	
14	50083387	Bush Hog Decal, 1.5" x 9.85"	1	
15	50031212	Amber Reflector	2	
16	50031214	Red Reflector	2	
17	89141	Caution Decal	1	
18	90960BH	Warning Decal	1	
19	00725746	Peligro Decal	1	
20	2850005	Lynch Pin, 7/16"	2	
21	-----	Serial No. Decal	1	Non Replaceable
22	50079010	Operators Manual	1	Not Shown



## CULTIPACKER MODELS CP1660, CP1672, CP1684, CP1696 3 Pt. Lift 16.3" Gray Iron Notched Wheels - 2" Axle

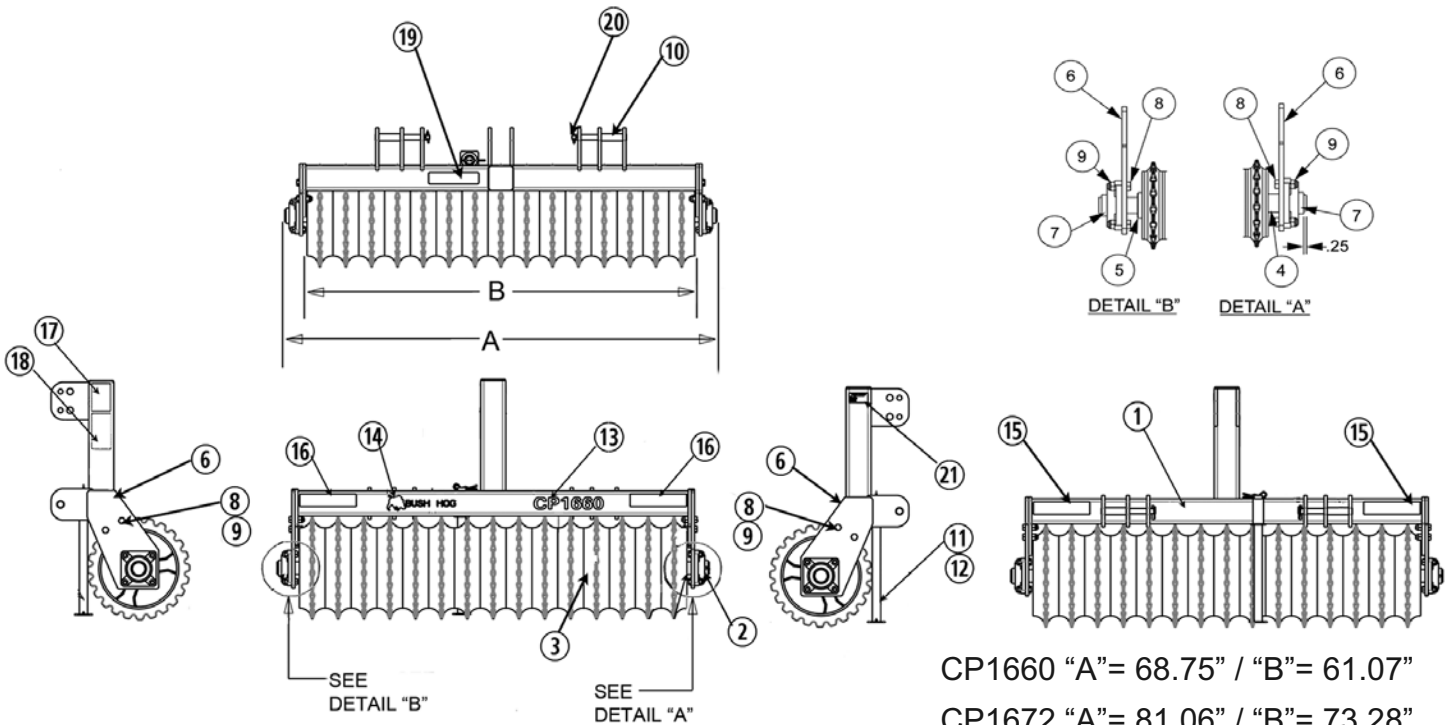

CP1660 "A"= 68.75" / "B"= 61.07"

CP1672 "A"= 81.06" / "B"= 73.28"

CP1684 "A"= 93.38" / "B"= 85.32"

CP1696 "A"= 105.75" / "B"= 97.70"

REF. NO.	PART NO.	DESCRIPTION	QTY.	NOTES
1	-----	Cultipacker Frame	1	Non Replaceable
2	50079022	Axle CP1660	1	
	50079029	Axle CP1672	1	
	50079030	Axle CP1684	1	
	50079031	Axle CP1696	1	
3	50079032	Wheel, 16.3" Notched/Gray Iron	A/R	15 CP1660, 18 CP1672, 21 CP1684, 24 CP1696
4	50079033	Axle Spacer	1	
5	50079025	Locking Collar 2" Axle	1	
6	50079026	Side Plate	2	
7	50079027	Bearing 2"	2	
8	20947	Capscrew 5/8" x 2" Gr.5	12	
9	45020BH	Locknut 5/8" Nylock	12	
10	99342	Pull Pin CAT 1 & 2	2	
11	50039221	Retainer Pin	1	
12	50079028	Jackstand	1	
13	50078892	Model Decal CP1660	1	
	50078894	Model Decal CP1672	1	
	50078896	Model Decal CP1684	1	
	50078898	Model Decal CP1696	1	
14	50083387	Bush Hog Decal, 1.5" x 9.85"	1	
15	50031212	Amber Reflector	2	
16	50031214	Red Reflector	2	
17	89141	Caution Decal	1	
18	90960BH	Warning Decal	1	
19	00725746	Peligro Decal	1	
20	2850005	Lynch Pin, 7/16"	2	
21	-----	Serial No. Decal	1	Non Replaceable
22	50079010	Operators Manual	1	Not Shown

# SAFETY DECALS & BUSH HOG MARKING

## MODEL CP Series Cultipackers

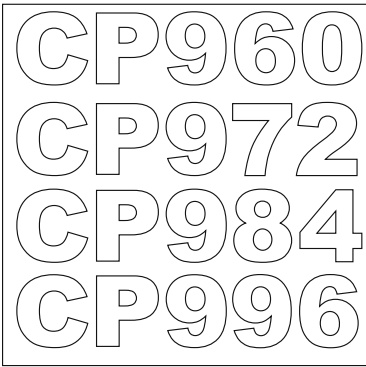

1

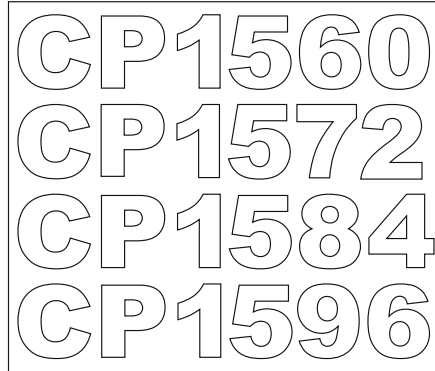

2

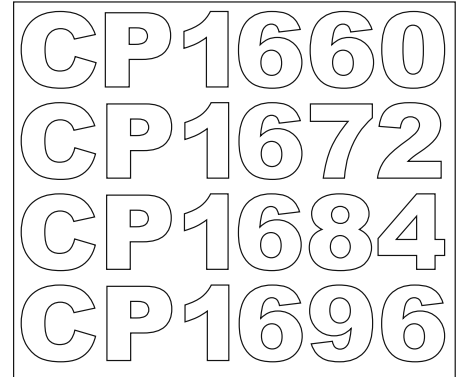

3

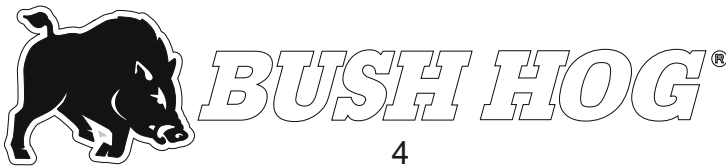

4



7



8



5



6

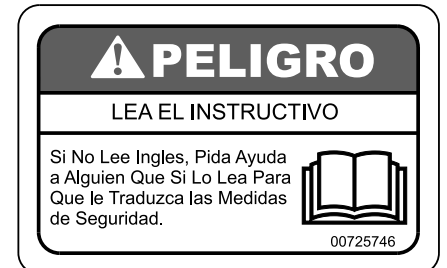

9

REF. NO.	PART NO.	DESCRIPTION	QTY.
1	50078876	Model Decal CP960	1
	50078878	Model Decal CP972	1
	50078880	Model Decal CP984	1
	50078882	Model Decal CP996	1
2	50078884	Model Decal CP1560	1
	50078886	Model Decal CP1572	1
	50078888	Model Decal CP1584	1
	50078890	Model Decal CP1596	1
3	50078892	Model Decal CP1660	1
	50078894	Model Decal CP1672	1
	50078896	Model Decal CP1684	1
	50078898	Model Decal CP1696	1
4	50083387	Bush Hog Decal	1
5	50031212	Amber Reflector	2
6	50031214	Red Reflector	2
7	89141	Caution Decal	1
8	90960BH	Warning Decal	1
9	00725746	Peligro Decal	1





**BUSH HOG<sup>®</sup>**

2501 Griffin Avenue • Selma, AL 36703

[www.bushhog.com](http://www.bushhog.com)