



# BUSH HOG®

# SUBSOILER

## MODEL SS1

Published 09/22

Part No.50072474

## OPERATOR'S MANUAL



This Operator's Manual is an integral part of the safe operation of this machine and must be maintained with the unit at all times. **READ, UNDERSTAND, and FOLLOW** the Safety and Operation Instructions contained in this manual before operating the equipment. *C01-Cover str*



FC-SS-0005

## BUSH HOG®

2501 Griffin Ave.  
Selma, AL 36703  
334-874-2700  
www.bushhog.com

Bush Hog Web Page



www.algqr.com/bwe

**¡ATENCIÓN!**  
LEA EL INSTRUCTIVO



Si No Lee Ingles, Pida  
Ayuda a Alguien  
Que Se Lo Lea Para Que le  
Traduzca Las  
Medidas de Seguridad

**A™ MEMBER OF THE  
ALAMO GROUP**  
ALWAYS ON THE CUTTING EDGE®

©2022 Alamo Group Inc.

## To the Owner/Operator/Dealer

All implements with moving parts are potentially hazardous. There is no substitute for a cautious, safe-minded operator who recognizes the potential hazards and follows reasonable safety practices. The manufacturer has designed this implement to be used with all its safety equipment properly attached to minimize the chance of accidents.

**BEFORE YOU START!** Read the safety messages on the implement and shown in your manual. Observe the rules of safety and common sense!

For future reference, record your Bush Hog product model number and serial number.

Dealer		Telephone		Model Number	
Owner		Purchase Date		Serial Number	



FC-SS-0006

### WARRANTY INFORMATION:

Read and understand the complete Warranty Statement found in this Manual. Fill out the Warranty Registration Form in full and return it to within 30 Days. Make certain the Serial Number of the Machine is recorded on the Warranty Card and on the Warranty Form that you retain.

# Table of Contents

<b>SAFETY SECTION .....</b>	<b>1 - 1</b>
GENERAL SAFETY INSTRUCTIONS AND PRACTICES .....	1 - 2
OPERATOR SAFETY INSTRUCTIONS AND PRACTICES .....	1 - 3
EQUIPMENT OPERATION SAFETY INSTRUCTIONS AND PRACTICES .....	1 - 5
CONNECTING OR DISCONNECTING SAFETY INSTRUCTIONS AND PRACTICES .....	1 - 7
MAINTENANCE AND SAFETY INSTRUCTIONS AND PRACTICES .....	1 - 7
STORAGE AND PARKING SAFETY INSTRUCTIONS AND PRACTICES.....	1 - 8
TRANSPORTING SAFETY INSTRUCTIONS AND PRACTICES .....	1 - 9
CONCLUDING SAFETY INSTRUCTIONS AND PRACTICES .....	1 - 10
PARTS INFORMATION .....	1 - 10
DECAL LOCATION .....	1 - 11
DECAL DESCRIPTION .....	1 - 12
FEDERAL LAWS AND REGULATIONS .....	1 - 13
<b>INTRODUCTION SECTION .....</b>	<b>2 - 1</b>
ATTENTION OWNER/OPERATOR.....	2 - 4
BUSH HOG LIMITED WARRANTY .....	2 - 5
<b>ASSEMBLY SECTION.....</b>	<b>3 - 1</b>
DEALER SET-UP INSTRUCTIONS .....	3 - 2
<b>OPERATION SECTION .....</b>	<b>4 - 1</b>
STANDARD EQUIPMENT AND SPECIFICATIONS .....	4 - 2
OPERATOR REQUIREMENTS .....	4 - 3
TRACTOR REQUIREMENTS .....	4 - 4
ROPS and Seat Belt.....	4 - 4
Tractor Horsepower.....	4 - 4
Front End Weight.....	4 - 4
GETTING ON AND OFF THE TRACTOR .....	4 - 5
Boarding the Tractor.....	4 - 5
Dismounting the Tractor .....	4 - 5
STARTING THE TRACTOR .....	4 - 6
CONNECTING THE IMPLEMENT TO THE TRACTOR .....	4 - 7
Connecting the Implement.....	4 - 7
PRE-OPERATION INSPECTION AND SERVICE .....	4 - 8
Tractor Pre-Operation Inspection/Service .....	4 - 8
Subsoiler Pre-Operation Inspection/Service.....	4 - 9
TRACTOR PRE-OPERATION INSPECTION .....	4 - 10
SUB SOILER PRE-OPERATION INSPECTION .....	4 - 11
DRIVING THE TRACTOR AND IMPLEMENT .....	4 - 12
Starting the Tractor.....	4 - 13
Brake and Differential Lock Setting .....	4 - 13
Driving the Tractor and Sub Soiler .....	4 - 14
OPERATING THE TRACTOR AND IMPLEMENT.....	4 - 14
Operating the Sub Soiler .....	4 - 14

# Table of Contents

SHUTTING DOWN THE IMPLEMENT .....	4 - 15
DISCONNECTING THE CULTIVATOR FROM THE TRACTOR.....	4 - 15
IMPLEMENT STORAGE .....	4 - 15
TRANSPORTING THE TRACTOR AND IMPLEMENT .....	4 - 16
Transporting on Public Roadways.....	4 - 17
Hauling the Tractor and Implement .....	4 - 19
<b>MAINTENANCE SECTION .....</b>	<b>5 - 1</b>
GENERAL MAINTENANCE.....	5 - 2
PROPER TORQUE FOR FASTENERS .....	5 - 2

# **SAFETY SECTION**

Safety Section 1-1

# SAFETY

## GENERAL SAFETY INSTRUCTIONS AND PRACTICES

A careful operator is the best operator. Safety is of primary importance to the manufacturer and should be to the owner/operator. Most accidents can be avoided by being aware of your equipment, your surroundings, and observing certain precautions. The first section of this manual includes a list of Safety Messages that, if followed, will help protect the operator and bystanders from injury or death. Read and understand these Safety Messages before assembling, operating or servicing this Implement. This equipment should only be operated by those persons who have read the manual, who are responsible and trained, and who know how to do so responsibly.



The Safety Alert Symbol combined with a Signal Word, as seen below, is used throughout this manual and on decals which are attached to the equipment. The Safety Alert Symbol means: "ATTENTION! BECOME ALERT! YOUR SAFETY IS INVOLVED!" The Symbol and Signal Word are intended to warn the owner/operator of impending hazards and the degree of possible injury faced when operating this equipment.

**Practice all usual and customary safe working precautions and above all--remember safety is up to YOU. Only YOU can prevent serious injury or death from unsafe practices.**



Indicates an imminently hazardous situation that, if not avoided, WILL result in DEATH OR VERY SERIOUS INJURY.



Indicates an imminently hazardous situation that, if not avoided, COULD result in DEATH OR SERIOUS INJURY.



Indicates an imminently hazardous situation that, if not avoided, MAY result in MINOR INJURY.

**Important**

Identifies special instructions or procedures that, if not strictly observed, could result in damage to, or destruction of the machine, attachments or the environment.

**NOTE:** *Identifies points of particular interest for more efficient and convenient operation or repair.* (SG-1) str

READ, UNDERSTAND, and FOLLOW the following Safety Messages. Death or serious injury may occur unless care is taken to follow the warnings and instructions stated in the Safety Messages. Always use good common sense to avoid hazards. (SG-2) str



Si no lee ingles, pida ayuda a alguien que si lo lea para que le traduzca las medidas de seguridad. (SG-3) str

**¡ LEA EL INSTRUCTIVO!**



# SAFETY

SAFETY

## OPERATOR SAFETY INSTRUCTIONS AND PRACTICES

### **⚠ WARNING**

Never crawl under a raised Implement supported solely by the Tractor 3-Point hitch. Release of the control lever or mechanical failure will result in the Implement falling and possible injury or death. Always securely block up the Implement before crawling underneath to perform repairs and service. (S3PT-19) str

### **⚠ DANGER**

Never operate the Tractor or Implement until you have read and completely understand this Manual, the Tractor Operator's Manual, and each of the Safety Messages found in the Manual or on the Tractor and Implement. Learn how to stop the tractor engine suddenly in an emergency. Never allow inexperienced or untrained personnel to operate the Tractor or Implement without supervision. Make sure the operator has fully read and understood the manuals prior to operation.

(SG-4)str



### **⚠ WARNING**

The operator and all support personnel should wear hard hats, safety shoes, safety glasses, and proper hearing protection at all times for protection from injury including injury from items that may be thrown by the equipment. (SG-16)str

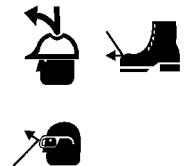

### **⚠ CAUTION**

PROLONGED EXPOSURE TO LOUD NOISE MAY CAUSE PERMANENT HEARING LOSS! Tractors with or without an Implement attached can often be noisy enough to cause permanent hearing loss. We recommend that you always wear hearing protection if the noise in the Operator's position exceeds 80db. Noise over 85db over an extended period of time will cause severe hearing loss. Noise over 90db adjacent to the Operator over an extended period of time will cause permanent or total hearing loss. **NOTE:** *Hearing loss from loud noise [from tractors, chain saws, radios, and other such sources close to the ear] is cumulative over a lifetime without hope of natural recovery.* (SG-17)str



### **⚠ WARNING**

Always read carefully and comply fully with the manufacturer's instructions when handling oil, solvents, cleansers, and any other chemical agent. (SG-22)str



### **⚠ DANGER**

KEEP AWAY FROM ROTATING ELEMENTS to prevent entanglement and possible death or serious injury. (SG-24)str



# SAFETY

**⚠ DANGER**

Never allow children to play on or around Tractor or Implement. Children can slip or fall off the Equipment and be killed or injured. Inadvertent contact with controls can cause the Implement to shift or fall crushing themselves or others. (SG-25) str

**⚠ DANGER**

DO NOT use drugs or alcohol immediately before or while operating the Tractor and Implement. Drugs and alcohol will affect an operator's alertness and coordination and therefore affect the operator's ability to operate the equipment safely. Before operating the Tractor or Implement, an operator on prescription or over-the-counter medication must consult a medical professional regarding any side effects of the medication that would hinder their ability to operate the Equipment safely. NEVER knowingly allow anyone to operate this equipment when their alertness or coordination is impaired. Serious injury or death to the operator or others could result if the operator is under the influence of drugs or alcohol. (SG-27) str



**⚠ WARNING**

Prolonged operation may cause operator boredom and fatigue affecting safe operation. Take scheduled work breaks to help prevent these potentially impaired operating conditions. Never operate the Implement and Tractor in a fatigued or bored mental state which impairs proper and safe operation. (SG-32) str

**⚠ WARNING**

Use extreme caution when getting onto the Implement to perform repairs, maintenance and when removing accumulated material. Only stand on solid flat surfaces to ensure good footing. Use a ladder or raised stand to access high spots which cannot be reached from ground level. Slipping and falling can cause serious injury or death. (SG-33) str

**⚠ DANGER**

DO NOT operate this Implement on a Tractor that is not properly maintained. Should a mechanical or Tractor control failure occur while operating, immediately shut down the Tractor and perform repairs before resuming operation. Serious injury and possible death could occur from not maintaining this Implement and Tractor in good operating condition. (SG-36) str



# SAFETY

## EQUIPMENT OPERATION SAFETY INSTRUCTIONS AND PRACTICES



There are obvious and hidden potential hazards in the operation of this implement as in all power-driven or pulled equipment. REMEMBER! This machine is often operated in rough terrain conditions that include tall grass, weeds, gullies, holes, slopes, hidden obstructions and the like. Serious injury or even death may occur unless care is taken to assure the safety of the operator and bystanders in the area. Do not operate this machine with anyone in the immediate area. (S3PT-07) str



This Implement may be wider than the Tractor. Be careful when operating or transporting this equipment to prevent the Implement from running into or striking sign posts, guard rails, concrete abutments or other solid objects. Such an impact could cause the Implement and Tractor to pivot violently resulting in loss of steering control, death, or serious injury. Never allow the Implement to contact obstacles. (S3PT-12)str



Be sure you have adequate knowledge of the property you will be working on. Take time to make yourself aware of any area underground lines or cables. Contact with buried lines or cable could result in **serious injury** or **death**. If in doubt about buried utility lines call 811 before digging or 1-800-258-0808. (SBH-6) str



Never leave the Implement and Power Unit unattended while the Implement is in the raised position. Accidental operation of a lifting lever or a hydraulic failure may cause the implement to suddenly fall causing serious injury or possible death to anyone who might inadvertently be under the Implement. Lower the implement carefully to the ground. Do not put hands or feet under lifted components. (SPU-03) str



Operate this Equipment only with a Tractor equipped with an approved roll-over-protective system (ROPS). Always wear seat belts. Death or serious injury could result from falling off the tractor, particularly during a turnover when the operator could be pinned under the ROPS. (SG-7) str



BEFORE leaving the tractor seat lower the implement, set the parking brake and/or set the tractor transmission in parking gear, disengage the PTO, stop the engine, remove the key, and wait for all moving parts to stop. Place the tractor shift lever into a low range or parking gear to prevent the tractor from rolling. Never dismount a Tractor that is moving or while the engine is running. Operate the Tractor controls from the tractor seat only. (SG-9)str

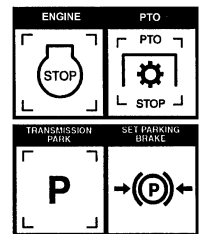

Never allow children or other persons to ride on the Tractor or Implement. Falling off can result in death or serious injury. (SG-10)str



# SAFETY



Never allow children to operate, ride on, or come close to the Tractor or Implement. Usually, 16-17 year-old children who are mature and responsible can operate the implement with adult supervision, if they have read and understand the Operator's Manuals, been trained in proper operation of the tractor and Implement, and are physically large enough to reach and operate the controls easily. (SG-11) str



Do not mount or dismount the Tractor while the tractor is moving. Mount the Tractor only when the Tractor and all moving parts are completely stopped. Dismounting a moving power unit can result in a crushing hazard that can cause death or serious injury. (SG-12) str



Start tractor only when properly seated in the Tractor seat. Starting a tractor in gear can result in death or serious injury. Read the Tractor operators manual for proper starting instructions. (SG-13) str



Never run the Tractor engine in a closed building or without adequate ventilation. The exhaust fumes can be hazardous to your health. (SG-23) str



Operate the Tractor and/or Implement controls only while properly seated in the Tractor seat with the seat belt securely fastened around you. Inadvertent movement of the Tractor or Implement may cause death or serious injury. (SG-29)str



In case of mechanical difficulty during operation, place the transmission in the park position, set the parking brake, shut down all power, including the PTO and the engine and remove the key. Wait until all rotating motion has stopped before dismounting. (SG-39) str



Do Not operate this equipment in areas where insects such as bees, may attack you and/or cause you to lose control of the equipment. If you must enter in such areas, use a tractor with an enclosed Cab and close the windows to prevent insects from entering. If a tractor cab is not available, wear suitable clothing including head, face, and hand protection to shield you from the insects. Attacking insects can cause you to lose control of the tractor, which can result in serious injury or death to you or bystanders. Never dismount a moving tractor. (SG-40) str

# SAFETY

## CONNECTING OR DISCONNECTING SAFETY INSTRUCTIONS AND PRACTICES



Always shut the Tractor completely down, place the transmission in park, and set the parking brake before you or anyone else attempts to connect or disconnect the Implement and Tractor hitches. (S3PT-15) str

## MAINTENANCE AND SAFETY INSTRUCTIONS AND PRACTICES



Never crawl under a raised Implement supported solely by the Tractor 3-Point hitch. Release of the control lever or mechanical failure will result in the Implement falling and possible injury or death. Always securely block up the Implement before crawling underneath to perform repairs and service. (S3PT-19) str



Never leave the Tractor and Implement unattended while the Implement is in the lifted position. Accidental operation of lifting lever or a hydraulic failure may cause sudden drop of unit with injury or death by crushing. To properly park the implement when disconnecting it from the tractor, lower the stand and put the retaining pin securely in place, or put a secure support under the A-Frame. Lower the implement carefully to the ground. Do not put hands or feet under lifted components. (S3PT-01) str



Keep fingers clear of adjusting holes. A sudden movement could cause injury or even amputate fingers. KEEP CHILDREN AWAY WHEN MAKING ADJUSTMENTS. (SBL-3) str



Always maintain the safety signs in good readable condition. If the safety signs are missing, damaged, or unreadable, obtain and install replacement safety signs immediately. (SG-5) str



Do not modify or alter this Implement. Do not permit anyone to modify or alter this Implement, any of its components or any Implement function. (SG-8) str



Never work under the Implement, the framework, or any lifted component unless the Implement is securely supported or blocked up to prevent sudden or inadvertent falling which could cause death or serious injury. (SG-14) str



Never attempt to lubricate, adjust, or remove material from the Implement while it is in motion or while tractor engine is running. (SG-20) str

# SAFETY

**WARNING**

Periodically inspect all moving parts for wear and replace when necessary with authorized service parts. Look for loose fasteners, worn or broken parts, and leaky or loose fittings. Make sure all pins have cotter pins and washers. Serious injury may occur from not maintaining this machine in good working order. (SG-21) str



**DANGER**

Do Not fill fuel tank while engine is running. Refuel only after engine has cooled down. If fuel is spilled, move machine away from the area of the spill and avoid creating any source of ignition until the spill has been cleaned up. (SG-28) str

**WARNING**

Perform service, repairs and lubrication according to the maintenance section. Ensure the unit is properly lubricated as specified in the lubrication schedule and all bolts and nuts are properly torqued. Failure to properly service, repair and maintain this Implement in good operating condition could cause component failure and possible serious injury or even death. (SG-35str)

**WARNING**

Use caution and wear protective gloves when handling sharp objects such as blades, knives, and other cutting edges. Be alert to worn component surfaces which have sharp edges. Sharp surfaces can inflict severe laceration injuries if proper hand protection is not worn. (SG-37) str

**WARNING**

Cancer and Reproductive Harm [www.P65Warnings.ca.gov](http://www.P65Warnings.ca.gov)

## STORAGE AND PARKING SAFETY INSTRUCTIONS AND PRACTICES

**DANGER**

A rear Implement can fall if not properly supported. Always use the stand on the front hitch (if equipped) or block up securely to prevent falling and possible crushing injury and/or other injury from holding or lifting heavy components. Use the stand to stabilize the implement during storage. (S3PT-3) str

# SAFETY

## TRANSPORTING SAFETY INSTRUCTIONS AND PRACTICES

### **WARNING**

Be particularly careful when transporting the Implement with the Tractor. Turn curves or go up hills only at a low speed and using a gradual steering angle. Rear mounted implements move the center of gravity to the rear and remove weight from the front wheels. Make certain, by adding front ballast, that at least 20% of the tractor's weight is on the front wheels to prevent rearing up, loss of steering control or Tractor tip-over. Slow down on rough or uneven surfaces to prevent loss of steering control which could result in property damage or possible injury. Do not transport unless 3-Point lift lever is fully raised and in the latched transport position. Dropping implement in transport can cause serious damage to the tractor and/or Implement and possibly cause the operator or others to be killed or injured. (S3PT-02)str

### **WARNING**

Make certain that the "Slow Moving Vehicle" (SMV) sign is installed in such a way as to be clearly visible and legible. When transporting the Equipment use the Tractor flashing warning lights and follow all local traffic regulations. (SG-6)str

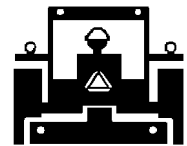

### **WARNING**

Transport only at speeds where you can maintain control of the equipment. Serious accidents and injuries can result from operating this equipment at high speeds. Understand the Tractor and Implement and how it handles before transporting on streets and highways. Make sure the Tractor steering and brakes are in good condition and operate properly.



Before transporting the Tractor and Implement, determine the proper transport speeds for you and the equipment. Make sure you abide by the following rules:

Test the tractor at a slow speed and increase the speed slowly. Apply the Brakes smoothly to determine the stopping characteristics of the Tractor and Implement. As you increase the speed of the Tractor the stopping distance increases. Determine the maximum transport speed not to exceed 20 mph (30 kph) for transporting this equipment.

Test the equipment at a slow speed in turns. Increase the speed through the turn only after you determine that the equipment can be operated at a higher speed. Use extreme care and reduce your speed when turning sharply to prevent the tractor and implement from turning over. Determine the maximum turning speed for you and this equipment before operating on roads or uneven ground.

Only transport the Tractor and Implement at the speeds which allow you to properly control the equipment.

Be aware of the operating conditions. Do not operate the Tractor with weak or faulty brakes or worn tires. When operating down a hill or on wet or rain slick roads, the braking distance increases: use extreme care and reduce your speed. When operating in traffic always use the Tractor's flashing warning lights and reduce your speed. Be aware of traffic around you and watch out for the other guy. (SG-19)str



# SAFETY

## **CONCLUDING SAFETY INSTRUCTIONS AND PRACTICES**

In addition to the design and configuration of this Implement, including Safety Signs and Safety Equipment, hazard control and accident prevention are dependent upon the awareness, concern, prudence, and proper training of personnel involved in the operation, transport, maintenance, and storage of the machine. Refer also to Safety Messages and operation instruction in each of the appropriate sections of the Tractor and Equipment Manuals. Pay close attention to the Safety Signs affixed to the Tractor and Equipment. (SG-18)str

## **PARTS INFORMATION**

Bush Hog products are designed utilizing specifically matched system components to ensure optimum equipment performance. These parts are made and tested to Bush Hog specifications. Non-genuine "will fit" parts do not consistently meet these specifications. The use of "will fit" parts may reduce equipment performance, void warranties, and present a safety hazard. Use genuine Bush Hog parts for economy and safety. (SPBH-2)str

SEE YOUR BUSH HOG DEALER

Operator's & Parts Manuals



[www.algqr.com/bpm](http://www.algqr.com/bpm)

SAFETY

# SAFETY

SAFETY

## DECAL LOCATION

**NOTE:** Bush Hog supplies safety decals on this product to promote safe operation. Damage to the decals may occur while in shipping, use, or reconditioning. Bush Hog cares about the safety of its customers, operators, and bystanders, and will replace the safety decals on this product in the field, free of charge (Some shipping and handling charges may apply). Contact your Bush Hog dealer to order replacement decals.

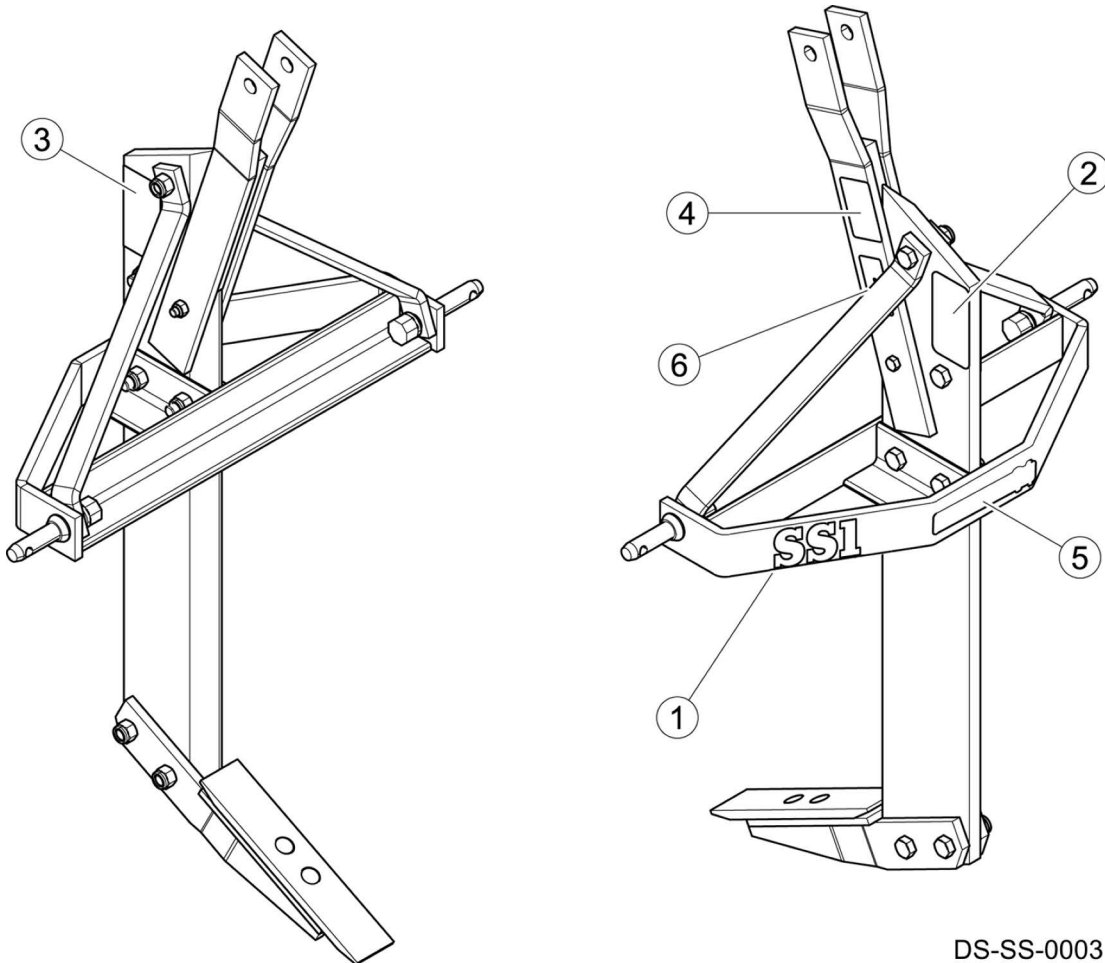

DS-SS-0003

ITEM	PART NO.	QTY	TYPE	DESCRIPTION
1.	50073326	1	LOGO	Model SS1
2.	50057097	1	CAUTION	Read Operator's Manual
3.	90960BH	1	WARNING	Implement Adjustments
4.	00725746	1	DANGER	Translate
5.	50062087	1	LOGO	Bush Hog Name
6.	NFS	1	SERIAL PLT	Serial Number Plate
7.	D960	1	WARNING	Proposition 65 (not shown)

# SAFETY

## DECAL DESCRIPTION

SAFETY

**! WARNING**



**TO AVOID SERIOUS INJURY OR DEATH:**

**1. DURING RAKE ADJUSTMENTS:**

- \* AVOID RAKE SWING DOWNHILL WHEN INDEX PINS ARE REMOVED; PLACE TRACTOR ON LEVEL GROUND.
- \* KEEP FINGERS AWAY FROM ADJUSTING HOLES.
- \* KEEP BODY, HANDS AND FEET CLEAR FROM ELEVATED RAKE AND MOVING PARTS.

**2. DURING RAKE OPERATION:**

- \* AVOID HIGH SPEED OVER ROUGH TERRAIN OR SLOPES.

90960BH

**! WARNING**

**Cancer and Reproductive Harm**

www.P65 Warnings.ca.gov D960

**! CAUTION**



**TO AVOID SERIOUS INJURY OR DEATH:**

- READ OPERATORS MANUAL BEFORE OPERATING AND FOLLOW ALL PRECAUTIONS (CONTACT DEALER FOR MANUAL).
- IT IS RECOMMENDED OPERATOR USE ROLLOVER PROTECTIVE SYSTEM AND SEAT BELT EQUIPPED TRACTOR FOR ALL IMPLEMENT OPERATIONS.
- ADD TRACTOR FRONT END WEIGHTS REQUIRED FOR TRACTOR STABILITY.
- LOWER IMPLEMENT TO GROUND, STOP ENGINE, PLACE TRANSMISSION IN NEUTRAL OR PARK, SET PARKING BRAKE AND REMOVE KEY BEFORE DISMOUNTING TRACTOR OR ADJUSTING IMPLEMENT.
- ALLOW NO RIDERS.
- TRANSPORT BLADE IN FULL RAISED POSITION WITH TILT AND OFFSET ANGLES AT "ZERO" POSITION.

50057097

**! PELIGRO**

LEA EL INSTRUCTIVO

Si No Lee Ingles, Pida Ayuda a Alguien Que Si Lo Lea Para Que le Traduzca las Medidas de Seguridad.



00725746



# SAFETY

## FEDERAL LAWS AND REGULATIONS

This section is intended to explain in broad terms the concept and effect of federal laws and regulations concerning employer and employee equipment operators. This section is not intended as a legal interpretation of the law and should not be considered as such.

### **Employer-Employee Operator Regulations**

U.S. Public Law 91-596 (The Williams-Steiger Occupational and Health Act of 1970) OSHA

#### **This Act Seeks:**

“...to assure so far as possible every working man and woman in the nation safe and healthful working conditions and to preserve our human resources...”

#### **DUTIES**

Sec. 5 (a) Each employer-

(1) shall furnish to each of his employees employment and a place of employment which are free from recognized hazards that are causing or are likely to cause death or serious physical harm to his employees;

(2) shall comply with occupational safety and health standards promulgated under this Act.

(b) Each employee shall comply with occupational safety and health standards and all rules, regulations and orders issued pursuant to this Act which are applicable to his own actions and conduct.

### **OSHA Training Requirements**

***Title 29, Code of Federal Regulations Part 1928.57(a)(6).*** [www.osha.gov](http://www.osha.gov)

Operator instructions. At the time of initial assignment and at least annually thereafter, the employer shall instruct every employee who operates an agricultural tractor and implements in the safe operating practices and servicing of equipment with which they are or will be involved, and of any other practices dictated by the work environment.

Keep all guards in place when the machine is in operation;

Permit no riders on equipment

Stop engine, disconnect the power source, and wait for all machine movement to stop before servicing, adjusting, cleaning or unclogging the equipment, except where the machine must be running to be properly serviced or maintained, in which case the employer shall instruct employees as to all steps and procedures which are necessary to safely service or maintain the equipment.

Make sure everyone is clear of machinery before starting the engine, engaging power, or operating the machine.

### **Employer Responsibilities:**

To ensure employee safety during Tractor and Implement operation, it is the employer's responsibility to:

1. Train the employee in the proper and safe operation of the Tractor and Implement.
2. Require that the employee read and fully understand the Tractor and Implement Operator's Manual.
3. Permit only qualified and properly trained employees to operate the Tractor and Implement.
4. Maintain the Tractor and Implement in a safe operational condition and maintain all shields and guards on the equipment.
5. Ensure the Tractor is equipped with a functional ROPS and seat belt and require that the employee operator securely fasten the safety belt and operate with the ROPS in the raised position at all times.
6. Forbid the employee operator to carry additional riders on the Tractor or Implement.
7. Provide the required tools to maintain the Tractor and Implement in a good safe working condition and provide the necessary support devices to secure the equipment safely while performing repairs and service.
8. Require that the employee operator stop operation if bystanders or passersby come within 300 feet.

### **Child Labor Under 16 Years of Age**

Some regulations specify that no one under the age of 16 may operate power machinery. It is your responsibility to know what these regulations are in your own area or situation. (Refer to U.S. Dept. of Labor, Employment Standard Administration, Wage & Home Division, Child Labor Bulletin #102.)



# **INTRODUCTION SECTION**

Introduction Section 2-1

# INTRODUCTION

This Sub Soiler is designed with care and built with quality materials by skilled workers. Proper assembly, maintenance, and operating practices, as described in this manual, will help the owner/operator get years of satisfactory service from the machine.

The purpose of this manual is to familiarize and instruct. The Assembly Section instructs the owner/operator in the correct assembly of the Sub Soiler.

Careful use and timely service saves extensive repairs and costly downtime losses. The Operation and Maintenance Sections of the manual train the owner/operator how to work the Sub Soiler correctly and attend to appropriate maintenance.

Safety is of primary importance to the owner/operator and to the manufacturer. The first section of this manual includes a list of Safety Messages, that, if followed, will help protect the operator and bystanders from injury or death. Many of the Safety Messages will be repeated throughout the manual. The owner/operator/dealer should know these Safety Messages before assembly and be aware of the hazards of operating this implement during assembly, use, and maintenance. The Safety Alert Symbol combined with a Signal Word, as seen below, is intended to warn the owner/operator of impending hazards and the degree of possible injury faced when operating this machine.



Indicates a hazardous situation that, if not avoided, WILL result in DEATH OR VERY SERIOUS INJURY.



Indicates a hazardous situation that, if not avoided, COULD result in DEATH OR SERIOUS INJURY.



Indicates a hazardous situation that, if not avoided, MAY result in MINOR OR MODERATE INJURY.



Identifies special instructions or procedures that, if not strictly observed, could result in damage to, or destruction of the machine, attachments or the environment.

# INTRODUCTION



FC-SS-0005

The Bush Hog 3-point standard duty subsoiler from Bush Hog is the right tool for you when breaking up a hardpan developed over years of use. Soils can become deeply compacted in areas tracked by heavy equipment during timber harvesting, firefighting, fuel reduction, cultivation, or other forest management operations. Layers of compacted soil restrict the movement of water, air, and roots, reducing the survival and growth of trees and other plants. This subsoiler is available with a single shank equipped with a replaceable tip capable of ripping the soil a depth of 19 inches. The beveled edge of the high carbon steel shank, combined with a heat-treated replaceable plow point, allows you to cut through the soil with minimal ground disturbance; shear pin protection is provided. The SS1 is designed for 25-45 Horsepower tractors with CAT I Standard and Quick Hitch.

Literature Page



[www.algqr.com/ble](http://www.algqr.com/ble)

## **WARNING**

At least 20% of the tractor's weight must be on the front tires with the implement lifted to provide adequate traction for safe steering under good conditions. Slow down on hills, rough terrain, and curves.

Front and rear, and left and right are determined by the normal direction of travel (the same as on your automobile).

Carefully read the Operator's Manual completely, understand the Safety Messages and instructions, and know how to operate correctly both the tractor and Blade.

SS1 09/22

Introduction Section 2-3

# INTRODUCTION

## **ATTENTION OWNER/OPERATOR**

BEFORE OPERATING THIS MACHINE

1. Carefully read the Operator's Manual, completely understand the Safety Messages and instructions, and know how to operate correctly both the tractor and implement.
2. Fill out the Warranty Card in full. Be sure to answer all questions, including the Serial Number of the implement. Mail within 30 days of delivery date of this implement.

**NOTE:** *Warranties are honored only if completed "Owner Registration and Warranty" forms are received by Alamo Group within thirty days of delivery of the implement.*

3. Record the Rake Model and Serial Numbers on the Warranty page at the front of the Operator's Manual. Keep this as part of the permanent maintenance file for the implement.

 **WARNING**

**TO AVOID DEATH OR SERIOUS INJURY:**

- ONLY use genuine Bush Hog replacement parts, which have been validated and tested to use on Bush Hog equipment by the manufacturer.
- The equipment manufacturer cannot verify the material or structural integrity of third-party supplied non-genuine replacement parts.
- Using non-genuine parts can result in the part failing, creating hazardous conditions for operator and bystanders.

Contact local dealer or Bush Hog about repair parts at:  
2501 Griffin Ave., Selma, AL 36701  
Customer Service: 800-363-6096.  
Email: [contactus@bushhog.com](mailto:contactus@bushhog.com)



**WARNING**

**Cancer and Reproductive Harm**

[www.P65Warnings.ca.gov](http://www.P65Warnings.ca.gov)

D859

# INTRODUCTION

## BUSH HOG LIMITED WARRANTY



INTRODUCTION

Bush Hog warrants to the original purchaser of any new Bush Hog equipment, purchased from an authorized Bush Hog dealer, that the equipment be free from defects in material and workmanship for a period of one (1) year for non-commercial, state and municipalities' use and ninety (90) days for commercial use from date of retail sale. The obligation of Bush Hog to the purchaser under this warranty is limited to the repair or replacement of defective parts.

Replacement or repair parts installed in the equipment covered by this limited warranty are warranted for ninety (90) days from the date of purchase of such part or to the expiration of the applicable new equipment warranty period, whichever occurs later. Warranted parts shall be provided at no cost to the user at an authorized Bush Hog dealer during regular working hours. Bush Hog reserves the right to inspect any equipment or parts which are claimed to have been defective in material or workmanship.

### DISCLAIMER OF IMPLIED WARRANTIES & CONSEQUENTIAL DAMAGES

Bush Hog's obligation under this limited warranty, to the extent allowed by law, is in lieu of all warranties, implied or expressed, **INCLUDING IMPLIED WARRANTIES OF MERCHANTABILITY AND FITNESS FOR A PARTICULAR PURPOSE** and any liability for incidental and consequential damages with respect to the sale or use of the items warranted. Such incidental and consequential damages shall include but not be limited to: transportation charges other than normal freight charges; cost of installation other than cost approved by Bush Hog; duty; taxes; charges for normal service or adjustment; loss of crops or any other loss of income; rental of substitute equipment, expenses due to loss, damage, detention or delay in the delivery of equipment or parts resulting from acts beyond the control of Bush Hog.

### THIS LIMITED WARRANTY SHALL NOT APPLY:

1. To vendor items which carry their own warranties, such as engines, tires, and tubes.
2. If the unit has been subjected to misapplication, abuse, misuse, negligence, fire or other accident.
3. If parts not made or supplied by Bush Hog have been used in connection with the unit, if, in the sole judgment of Bush Hog such use affects its performance, stability or reliability.
4. If the unit has been altered or repaired outside of an authorized Bush Hog dealership in a manner which, in the sole judgment of Bush Hog, affects its performance, stability or reliability.
5. To normal maintenance service and normal replacement items such as gearbox lubricant, hydraulic fluid, worn blades, or to normal deterioration of such things as belts and exterior finish due to use or exposure.
6. To expendable or wear items such as teeth, chains, sprockets, belts, springs and any other items that in the company's sole judgment is a wear item.

NO EMPLOYEE OR REPRESENTATIVE OF BUSH HOG IS AUTHORIZED TO CHANGE THIS LIMITED WARRANTY IN ANY WAY OR GRANT ANY OTHER WARRANTY UNLESS SUCH CHANGE IS MADE IN WRITING AND SIGNED BY BUSH HOG'S SERVICE MANAGER, 2501 GRIFFIN AVE., SELMA, ALABAMA 36703.



Record the model number, serial number and date purchased. This information will be helpful to your dealer if parts or service are required.

MODEL NUMBER \_\_\_\_\_

SERIAL NUMBER \_\_\_\_\_

MAKE CERTAIN THE WARRANTY HAS BEEN FILED WITH BUSH HOG SELMA, ALABAMA

DATE OF RETAIL SALE \_\_\_\_\_



**BUSH HOG®**





# ASSEMBLY SECTION

Assembly Section 3-1

# ASSEMBLY

## **DEALER SET-UP INSTRUCTIONS**

The Bush Hog SS1 Subsoiler is shipped fully assembled from the factory. Refer to the parts drawing or contact a Bush Hog dealer for further assistance if needed.



Always use personal protection devices such as eye and ear protectors during assembly.

ASSEMBLY

# OPERATION SECTION

Operation Section 4-1

# OPERATION

## SS1 HEAVY DUTY SUBSOILER

### 1. OPERATING INSTRUCTIONS

Your Subsoiler should now be assembled and inspected for any evidence of defective or damaged parts before use. Any evidence of damage should be reported to your dealer immediately.

This section of the Operator's Manual is designed to familiarize, instruct, and educate safe and proper implement use to the operator. Pictures contained in this section are intended to be used as a visual aid to assist in explaining the operation of a cultivator and are not necessarily of this implement. Some pictures may show shields removed for purposes of clarity. NEVER OPERATE this implement without all shields in place and in good operational condition. The operator must be familiar with the subsoiler and tractor operation and all associated safety practices before operating the subsoiler and tractor. Proper operation of the subsoiler as detailed in this manual, will help ensure years of safe and satisfactory use of the subsoiler.

**READ AND UNDERSTAND THE ENTIRE OPERATING INSTRUCTIONS AND SAFETY SECTION OF THIS MANUAL AND THE TRACTOR MANUAL BEFORE ATTEMPTING TO USE THE TRACTOR AND IMPLEMENT.** If you do not understand any of the instructions, contact your nearest authorized dealer for a full explanation. Pay close attention to all safety signs and safety messages contained in this manual and those affixed to the implement and tractor. OPS-U- 0001str

READ, UNDERSTAND, and FOLLOW the following Safety Messages. Death or serious injury may occur unless care is taken to follow the warnings and instructions stated in the Safety Messages. Always use good common sense to avoid hazards. (SG-2str)



### 2. STANDARD EQUIPMENT AND SPECIFICATIONS

	SS1 Sub Soiler
	Sub Soiler (Standard)
Hitch	CAT 1 Std & Quick Hitch
Overall Width	32-3/8"
Overall Height	50"
Horsepower	25 - 45 HP
Weight	113 lbs
Shank Size	3/4" x 6"
Number of Shanks	1
Cutting Point	1/2" x 2-1/2" x 12"

# OPERATION

## 3. OPERATOR REQUIREMENTS

Safe operation of the unit is the responsibility of a qualified operator. A qualified operator has read and understands the implement and tractor Operator's Manuals and is experienced in implement and tractor operation and all associated safety practices. In addition to the safety messages contained in this manual, safety signs are affixed to the implement and tractor. If any part of the operation and safe use of this equipment is not completely understood, consult an authorized dealer for a complete explanation.

If the operator cannot read the manuals for themselves or does not completely understand the operation of the equipment, it is the responsibility of the supervisor to read and explain the manuals, safety practices, and operating instructions to the operator.

Safe operation of equipment requires that the operator wear approved Personal Protective Equipment (PPE) for the job conditions when attaching, operating, servicing, and repairing the equipment. PPE is designed to provide operator protection and includes the following safety wear:

### PERSONAL PROTECTIVE EQUIPMENT (PPE)

- Always Wear Safety Glasses (with side shields marked to comply with ANSI Z87)
- Hard Hat
- Steel Toe Safety Footwear
- Gloves
- Hearing Protection
- Close Fitting Clothing
- Respirator or Filter Mask (depends on operating conditions)

OPS-U- 0002str

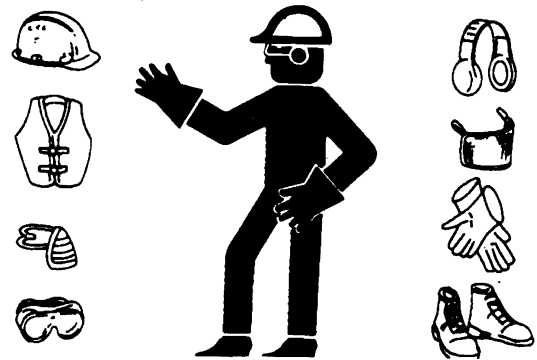

DO NOT use drugs or alcohol immediately before or while operating the Tractor and Implement. Drugs and alcohol will affect an operator's alertness and coordination and therefore affect the operator's ability to operate the equipment safely. Before operating the Tractor or Implement, an operator on prescription or over-the-counter medication must consult a medical professional regarding any side effects of the medication that would hinder their ability to operate the Equipment safely. NEVER knowingly allow anyone to operate this equipment when their alertness or coordination is impaired. Serious injury or death to the operator or others could result if the operator is under the influence of drugs or alcohol. (SG-27) str

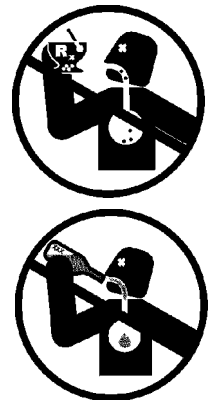

# OPERATION

## **4. TRACTOR REQUIREMENTS**

Operating the cultivator with a tractor that does not meet the following requirements may cause tractor or implement damage and be a potential danger to the operator and passersby..

### **Tractor Requirements and Capabilities**

- ASABE approved Roll-Over Protective Structure (ROPS) or ROPS cab and seat belt.
- Tractor Safety Devices ..... Slow Moving Vehicle (SMV) emblem, lighting, PTO master shield
- Tractor Horsepower ..... 25 - 45 HP
- Front End Weights ..... As needed to maintain 20% weight on front axle

### **4.1 ROPS and Seat Belt**

The tractor must be equipped with a Roll-Over-Protective-Structure (ROPS) (tractor cab or roll-bar) and seat belt to protect the operator from falling off the tractor, especially during a roll over where the driver could be crushed and killed. Only operate the tractor with the ROPS in the raised position and seat belt fastened. Tractor models not equipped with a ROPS and seat belt should have these life saving features installed by an authorized dealer. OPS-U- 0003str



Operate this Equipment only with a Tractor equipped with an approved roll-over-protective system (ROPS). Always wear seat belts. Death or serious injury could result from falling off the tractor, particularly during a turnover when the operator could be pinned under the ROPS. (SG-7) str



### **4.2 Tractor Horsepower**

The power required to operate this implement is determined by the tractor PTO horsepower. For most operating conditions, this implement requires a tractor with at least 25 HP to 45 HP range. Operating these implements with a tractor that does not have adequate power may damage the tractor engine. Exceeding the recommended horsepower may cause aerator damage by overpowering the unit in heavy operating conditions.

### **4.3 Front End Weight**

A minimum of 20% total tractor weight must be maintained on the tractor front end at all times. Front end weight is critical to maintain steering control and to prevent the tractor from rearing up while driving. If the front end is too light, add weight until a minimum of 20% total weight is reached on the front tires. Front weights and weight carriers can be purchased through an authorized tractor dealership. OPS-U-0005 str

# OPERATION

## 5. GETTING ON AND OFF THE TRACTOR

Before getting onto the tractor, the operator must read and completely understand the implement and tractor operator manuals. If any part of either manual is not completely understood, consult an authorized dealer for a complete explanation. OPS-U- 0007str



Do not mount or dismount the Tractor while the tractor is moving. Mount the Tractor only when the Tractor and all moving parts are completely stopped. Dismounting a moving power unit can result in a crushing hazard that can cause death or serious injury. (SG-12) str



### 5.1 Boarding the Tractor

Use both hands and equipped handrails and steps for support when boarding the tractor. Never use control levers for support when mounting the tractor. Seat yourself in the operator's seat and secure the seat belt around you.

Never allow passengers to ride on the tractor or attached equipment. Riders can easily fall off and be seriously injured or killed from falling off and being ran over. It is the operator's responsibility to forbid all extra riders at all times. OPS-U- 0008str



Never allow children to operate, ride on, or come close to the Tractor or Implement. Usually, 16-17 year-old children who are mature and responsible can operate the implement with adult supervision, if they have read and understand the Operator's Manuals, been trained in proper operation of the tractor and Implement, and are physically large enough to reach and operate the controls easily. (SG-11) str



Never allow children or other persons to ride on the Tractor or Implement. Falling off can result in death or serious injury. (SG-10)str



### 5.2 Dismounting the Tractor

Before dismounting, park the tractor and implement on a reasonably level surface, apply the parking brake, idle the engine down, disengage the PTO, and lower the implement to the ground. Shut down the tractor engine according to the operator's manual, remove the key, and wait for all motion to completely stop. Never leave the seat until the tractor, its engine and all moving parts have come to a complete stop.

Use hand rails and steps when exiting the tractor. Be careful of your step and use extra caution when mud, ice, snow or other matter has accumulated on the steps or hand rails. Use all handrails and steps for support and never rush or jump off the tractor. OPS-U- 0009 str



BEFORE leaving the tractor seat lower the implement, set the parking brake and/or set the tractor transmission in parking gear, disengage the PTO, stop the engine, remove the key, and wait for all moving parts to stop. Place the tractor shift lever into a low range or parking gear to prevent the tractor from rolling. Never dismount a Tractor that is moving or while the engine is running. Operate the Tractor controls from the tractor seat only. (SG-9)str

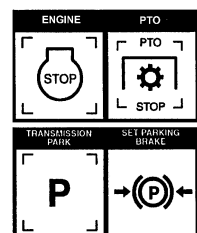

# OPERATION

## **6. STARTING THE TRACTOR**

The operator must have a complete understanding of the placement, function, and operational use of all tractor controls before starting the tractor. Review the tractor operator's manual and consult an authorized dealer for tractor operation instructions if needed.

### **Essential Tractor Controls:**

- Locate the light control switch.
- Locate the engine shut off control.
- Locate the brake pedals and the clutch.
- Locate the PTO control.
- Locate the 3-point hitch control lever.
- Locate the hydraulic remote control levers

### **Before starting the tractor ensure the following:**

- Conduct all pre-start operation inspection and service according to the tractor operator's manual.
- Make sure all guards, shields, and other safety devices are securely in place.
- The parking brake is on.
- The PTO control lever is disengaged.
- The 3-point hitch control lever is in the lowered position.
- The hydraulic remote control levers are in the neutral position.
- The tractor transmission levers are in park or neutral.

Refer to the tractor owner's manual for tractor starting procedures. Only start the tractor while seated and belted in the tractor operator's seat. Never bypass the ignition switch by short circuiting the starter solenoid. After the tractor engine is running, avoid accidental contact with the tractor transmission to prevent sudden and unexpected tractor movement. OPS-U-0028str



Never run the Tractor engine in a closed building or without adequate ventilation. The exhaust fumes can be hazardous to your health. (SG-23) str



Start tractor only when properly seated in the Tractor seat. Starting a tractor in gear can result in death or serious injury. Read the Tractor operators manual for proper starting instructions. (SG-13) str





# OPERATION

## **7. CONNECTING THE IMPLEMENT TO THE TRACTOR**

Use extreme caution when connecting the implements to the tractor. The implement should be securely resting at ground level or setting on blocks. Keep hands and feet from under the units and clear of pinch points between the tractor hitch arms and implement pins. *OPS-0011\_B str*

IMPORTANT: Scan this QR Code with your smart phone to link to the PAMI Safe Implement Hitching Manual for more information on correctly connecting agricultural tractors to implements. Or type in your internet browser the following web address: [www.algqr.com/hme](http://www.algqr.com/hme) *Ops-0008-MISC str*



OPERATION

### **7.1 Connecting the Implement**

1. Shorten or remove the tractor drawbar to avoid interference when raising and lowering the equipment.
2. Board the tractor and start the engine. Position the tractor to the equipment with the 3-point lift arms positioned between the respective set of equipments.

**NOTE:** Set the 3-point lift control to "Position Control" so that the lift arms maintain a constant height when attaching the equipment. See the Tractor Operator's Manual for correct settings when attaching 3-point equipment..

3. Turn off the tractor engine, set the parking brake,
4. Lift one arm at a time, align arm end hole between the set of holes of A-Frame lift lugs. Insert hitch pin through the lug and arm holes and insert retaining pin into hitch pin. Walk around to opposite side and repeat procedure for remaining lift arm and hitch pin.
5. Extend or retract the 3-point top link to align top end hole with the holes of the cultivator top link. Insert the top link pin and retain with cotter pin.
6. Adjust any lower link check chains guide blocks, or sway blocks to prevent the equipment from swaying side to side and possible contact with tractor rear tires.



# OPERATION

## **8. PRE-OPERATION INSPECTION AND SERVICE**

Before each use, a pre-operation inspection and service of the implement and tractor must be performed. This includes routine maintenance and scheduled lubrication, inspecting that all safety devices are equipped and functional, and performing needed repairs. DO NOT operate the unit if the pre-operation inspection reveals any condition affecting safe operation. Perform repairs and replacement of damaged and missing parts as soon as noticed. By performing a thorough pre-operation inspection and service, valuable down time and repair cost can be avoided. OPS-U-0029str



Periodically inspect all moving parts for wear and replace when necessary with authorized service parts. Look for loose fasteners, worn or broken parts, and leaky or loose fittings. Make sure all pins have cotter pins and washers. Serious injury may occur from not maintaining this machine in good working order. (SG-21 )str

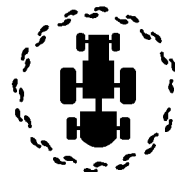

OPERATION

### **8.1 Tractor Pre-Operation Inspection/Service**

Refer to the tractor operator's manual to ensure a complete pre-operation inspection and scheduled service is performed according to the manufacturers recommendations. The following are some of the items that require daily service and inspection:

- Tire condition/air pressure
- Wheel lug bolts
- Steering linkage
- PTO shield
- SMV sign is clean and visible
- Tractor's lights are clean and functional
- Tractor Seat belt is in good condition
- ROPS is in the raised position
- No tractor oil leaks
- Radiator free of debris
- Engine oil level and condition
- Engine coolant level and condition
- Power brake fluid level
- Power steering fluid level
- Fuel condition and level
- Sufficient lubrication at all lube points
- Air filter condition OPS-U-0030 str



# OPERATION

## 8.2 Subsoiler Pre-Operation Inspection/Service

Before each use, a complete inspection and service is required to ensure the aerator is in good and safe working condition. Damaged and/or broken parts should be repaired and/or replaced immediately. To ensure the aerator is ready for operation, conduct the following. *OPS-SS-0001 str*

### **WARNING**

Periodically inspect all moving parts for wear and replace when necessary with authorized service parts. Look for loose fasteners, worn or broken parts, and leaky or loose fittings. Make sure all pins have cotter pins and washers. Serious injury may occur from not maintaining this machine in good working order. (SG-21 )str



The operator's manual and safety signs affixed on the unit contain important instructions on the safe and proper use of the equipment. Maintain these important safety features on the implement in good condition to ensure the information is available to the operator at all times.

- Ensure the manual canister is secured to the equipment with the operator's manual inside.
- Ensure all safety signs are in place and legible. Replace missing, damaged, and illegible decals. *OPS-U- 0011 str*



Op-14

# OPERATION

## TRACTOR PRE-OPERATION INSPECTION



Tractor ID# \_\_\_\_\_ Make: \_\_\_\_\_

Date: \_\_\_\_\_ Shaft: \_\_\_\_\_



Before conducting the inspection, make sure the tractor engine is off, all rotation has stopped and the tractor is in park with the parking brake engaged. Make sure the mower is resting on the ground or securely blocked up and all hydraulic pressure has been relieved.

**OPERATION**

Item	Condition at Start of Shift	Specific Comments if not OK
The flashing lights function properly		
The SMV Sign is clean and visible		
The tires are in good condition with proper pressure		
The wheel lug bolts are tight		
The tractor brakes are in good condition		
The steering linkage is in good condition		
There are no visible oil leaks		
The hydraulic controls function properly		
The ROPS or ROPS Cab is in good condition		
The seatbelt is in place and in good condition		
The 3-point hitch is in good condition		
The drawbar pins are securely in place		
The PTO master shield is in place		
The engine oil level is full		
The brake fluid level is full		
The power steering fluid level is full		
The fuel level is adequate		
The engine coolant fluid level is full		
The radiator is free of debris		
The air filter is in good condition		

Operator's Signature: \_\_\_\_\_

**DO NOT OPERATE an UNSAFE TRACTOR or MOWER**

# OPERATION

## SUB SOILER PRE-OPERATION INSPECTION



Sub Soiler ID# \_\_\_\_\_

Date: \_\_\_\_\_

Make: \_\_\_\_\_

Shift: \_\_\_\_\_



**WARNING**

Before conducting the inspection, make sure the tractor engine is off, all rotation has stopped and the tractor is in park with the parking brake engaged. Make sure the blade is resting on the ground or securely blocked up and all hydraulic pressure has been relieved.

Item	Condition at Start of Shift	Specific Comments if not OK
The Operator's Manual has been read and understood		
All safety decals are in place and legible		
The hitch connection pins are properly retained		
There are no cracks in the Hitch		
All bolts are in place and properly tightened		
All grease fittings and lubrication points have been serviced		
Check for chips, cracked or worn parts		

Operator's Signature: \_\_\_\_\_

**DO NOT OPERATE an UNSAFE TRACTOR or IMPLEMENT**

OPERATION

# OPERATION

## 9. DRIVING THE TRACTOR AND IMPLEMENT

Safe tractor transport requires the operator possess a thorough knowledge of the model being operated and precautions to take while driving with an attached implement. Ensure the tractor has the capacity to handle the weight of the implement and the tractor operating controls are set for safe transport. To ensure safety while driving the tractor with an attached implement, review the following. OPS-U- 0012str



This Implement may be wider than the Tractor. Be careful when operating or transporting this equipment to prevent the Implement from running into or striking sign posts, guard rails, concrete abutments or other solid objects. Such an impact could cause the Implement and Tractor to pivot violently resulting in loss of steering control, death, or serious injury. Never allow the Implement to contact obstacles. (S3PT-12)str



Transport only at speeds where you can maintain control of the equipment. Serious accidents and injuries can result from operating this equipment at high speeds. Understand the Tractor and Implement and how it handles before transporting on streets and highways. Make sure the Tractor steering and brakes are in good condition and operate properly.



Before transporting the Tractor and Implement, determine the proper transport speeds for you and the equipment. Make sure you abide by the following rules:

Test the tractor at a slow speed and increase the speed slowly. Apply the Brakes smoothly to determine the stopping characteristics of the Tractor and Implement. As you increase the speed of the Tractor the stopping distance increases. Determine the maximum transport speed not to exceed 20 mph (30 kph) for transporting this equipment.

Test the equipment at a slow speed in turns. Increase the speed through the turn only after you determine that the equipment can be operated at a higher speed. Use extreme care and reduce your speed when turning sharply to prevent the tractor and implement from turning over. Determine the maximum turning speed for you and this equipment before operating on roads or uneven ground.



Only transport the Tractor and Implement at the speeds which allow you to properly control the equipment.

Be aware of the operating conditions. Do not operate the Tractor with weak or faulty brakes or worn tires. When operating down a hill or on wet or rain slick roads, the braking distance increases: use extreme care and reduce your speed. When operating in traffic always use the Tractor's flashing warning lights and reduce your speed. Be aware of traffic around you and watch out for the other guy. (SG-19)str

# OPERATION

## **9.1 Starting the Tractor**

The procedure to start the tractor is model specific. Refer to the tractor operator's manual for starting procedures for your particular tractor. Consult an authorized dealer if the starting procedure is unclear. Ensure the 3-point control lever is in the lowered position and the PTO is disengaged before starting the tractor. OPS-U-0033str



## **9.2 Brake and Differential Lock Setting**

Make sure the tractor brakes are in good operating condition. Tractor brakes can be set to operate independently allowing single rear wheel braking action or locked together to provide simultaneous rear wheel braking. FOR MOST DRIVING AND OPERATING CONDITIONS, THE BRAKE PEDALS SHOULD BE LOCKED TOGETHER TO PROVIDE THE MOST EFFECTIVE BRAKING ACTION.

Always disengage the tractor differential lock when turning. When engaged the differential lock will prevent or limit the tractor from turning. During normal cutting conditions, locking the differential provides no benefit and should not be used.

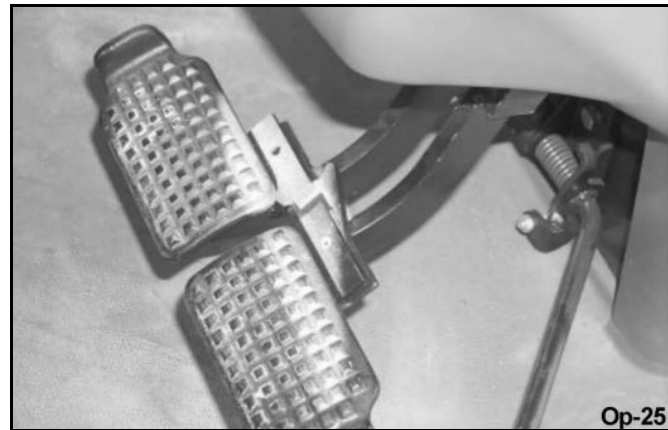

### **WARNING**

Be aware of the operating conditions. Do not operate the Tractor with weak or faulty brakes. When operating down a hill or on wet or rain slick roads, the braking distance increases. Use extreme care and reduce your speed in these conditions. When operating in traffic, always use the Tractor's flashing warning lights and reduce your speed. Be aware of traffic around you and watch out for the other guy. OPS-U- 0013 str

# OPERATION

## **9.3 Driving the Tractor and Sub Soiler**

Start off driving at a slow speed and gradually increase your speed while maintaining complete control of the tractor and unit. Moving slowly at first will also prevent the tractor from rearing up and loss of steering control. The tractor should never be operated at speeds that cannot be safely handled or which will prevent the operator from stopping quickly during an emergency. If the power steering or engine ceases operating, stop the tractor immediately as the tractor will be difficult to control.

Perform turns with the tractor and units at slow speeds to determine how the tractor with an attached cultivator handles a turn. Determine the safe speed to maintain proper control of the tractor when making turns. When turning with a towed implement, the overall working length of the unit is increased. Allow additional clearance for the units when turning.

To avoid overturns, drive the tractor with care and at safe speeds, especially when operating over rough ground, crossing ditches or slopes, and turning corners. Tractor wheel tread spacing should be increased when working on inclines or rough ground to reduce the possibility of tipping.

Use extreme caution when operating on steep slopes. Keep the tractor in a low gear when going downhill. DO NOT coast or free-wheel downhill. *OPS-SS-0002 str*

## **10. OPERATING THE TRACTOR AND IMPLEMENT**

**THE OPERATOR MUST COMPLETELY UNDERSTAND HOW TO OPERATE THE TRACTOR AND IMPLEMENT AND ALL CONTROLS BEFORE ATTEMPTING TO OPERATE.**

The operator must read and understand the Safety and Operation Sections of the implement and tractor operator's manuals. These manuals must be read and explained to any operator who cannot read. Never allow someone to operate the implement and tractor without complete operating instructions.

Before starting any operation, the operator must become familiar with the area to be worked in and any obstacles and hazards contained within to ensure safety to the operator, bystanders, and equipment. Special attention should be paid to foreign debris, rough terrain, steep slopes, and passersby and animals in the area. *OPS-U- 0015 str*

### **10.1 Operating the Sub Soiler**

Before using the Sub Soiler on any job, first remove any sticks, limbs, rocks, concrete or debris from the area. Before cultivating any area that employs irrigation or uses a sprinkler system, mark sprinklers heads with flags so they can be avoided. Locate and avoid any shallow buried telephone, TV, electrical cables or gas lines.



Never allow riders for any reason.



# OPERATION

## 11.SHUTTING DOWN THE IMPLEMENT

To shut down the implement, first bring the tractor to a complete stop.

Park the tractor on a level surface, place the transmission in park or neutral and apply the parking brake, lower the attached implement to the ground, shut down the engine, remove the key, before exiting the tractor.

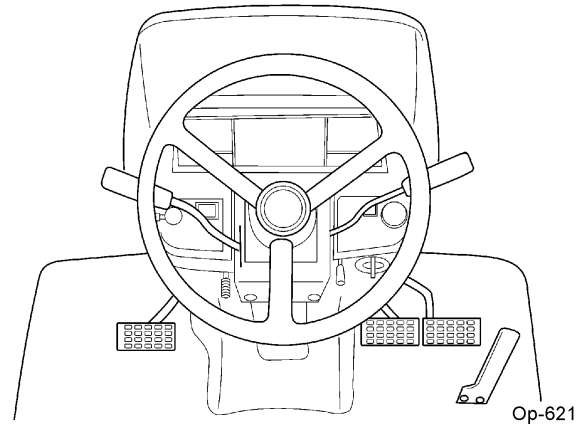

## 12.DISCONNECTING THE CULTIVATOR FROM THE TRACTOR

Before disconnecting the cultivator, all movement must cease. Move the implement to a level storage location and lower the unit to the ground. If the cultivator is not resting securely on the ground, block the implement up securely before attempting to disconnect it from the tractor.

Use extreme care to keep feet and hands from under the cultivator and clear of any pinch points. OPS- C-0003 str



Always shut the Tractor completely down, place the transmission in park, and set the parking brake before you or anyone else attempts to connect or disconnect the Implement and Tractor hitches. (S3PT-15) str

## 13.IMPLEMENT STORAGE

Properly preparing and storing the cultivator at the end of the season is critical to maintaining its appearance and to help ensure years of dependable service. The following are suggested storage procedures:

- Thoroughly clean all debris off the unit to prevent damage from rotting grass and standing water.
- Lubricate all grease points as detailed in the maintenance section.
- Tighten all bolts and pins to the recommended torque.
- Check the unit for worn and damaged parts. Perform repairs and make replacements immediately so that the unit will be ready for use at the start of the next season.
- Store the unit in a clean, dry place with the implement resting securely on blocks or at ground level.
- Use spray touch-up enamel where necessary to prevent rust and maintain the appearance of the unit.



Never allow children to play on or around Tractor or Implement. Children can slip or fall off the Equipment and be killed or injured. Inadvertent contact with controls can cause the Implement to shift or fall crushing themselves or others. (SG-25) str

# OPERATION

## 14. TRANSPORTING THE TRACTOR AND IMPLEMENT

Inherent hazards of operating the tractor and implement and the possibility of accidents are not left behind when you finish working in an area. Therefore, the operator must employ good judgment and safe operation practices when transporting the tractor and implement between locations. By using good judgment and following safe transport procedures, the possibility of accidents while moving between locations can be substantially minimized. OPS-U- 0017str



**WARNING** Transport only at speeds where you can maintain control of the equipment. Serious accidents and injuries can result from operating this equipment at high speeds. Understand the Tractor and Implement and how it handles before transporting on streets and highways. Make sure the Tractor steering and brakes are in good condition and operate properly.



Before transporting the Tractor and Implement, determine the proper transport speeds for you and the equipment. Make sure you abide by the following rules:

Test the tractor at a slow speed and increase the speed slowly. Apply the Brakes smoothly to determine the stopping characteristics of the Tractor and Implement. As you increase the speed of the Tractor the stopping distance increases. Determine the maximum transport speed not to exceed 20 mph (30 kph) for transporting this equipment.

Test the equipment at a slow speed in turns. Increase the speed through the turn only after you determine that the equipment can be operated at a higher speed. Use extreme care and reduce your speed when turning sharply to prevent the tractor and implement from turning over. Determine the maximum turning speed for you and this equipment before operating on roads or uneven ground.

Only transport the Tractor and Implement at the speeds which allow you to properly control the equipment.



Be aware of the operating conditions. Do not operate the Tractor with weak or faulty brakes or worn tires. When operating down a hill or on wet or rain slick roads, the braking distance increases: use extreme care and reduce your speed. When operating in traffic always use the Tractor's flashing warning lights and reduce your speed. Be aware of traffic around you and watch out for the other guy. (SG-19)str



**DANGER** Never allow children or other persons to ride on the Tractor or Implement. Falling off can result in death or serious injury. (SG-10)str



# OPERATION

Before transporting the tractor on a public roadway or boarding a trailer for transport, the tractor brake pedals should be locked together. Locking the pedals ensures that both wheels brake simultaneously while stopping, especially when making an emergency stop.

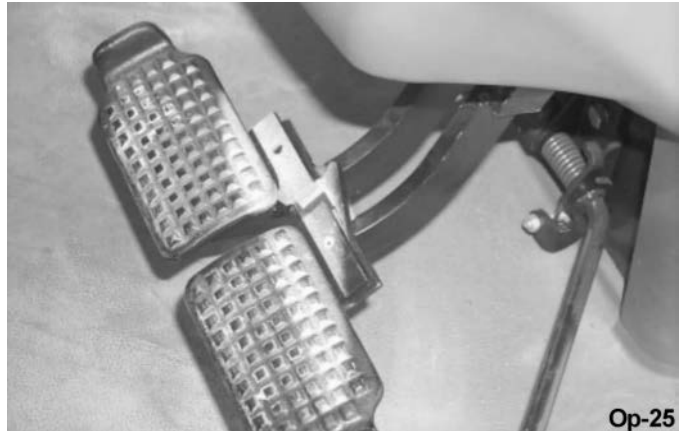

Use extreme caution and avoid hard applications of the tractor brakes when towing heavy loads at road speeds. Never tow the implement at speeds greater than 20 MPH (32 kph). OPS-U-0018str

## 14.1 Transporting on Public Roadways

Extreme caution should be used when transporting the tractor and implement on public roadways. The tractor must be equipped with all required safety warning features including a SMV emblem and flashing warning lights to alert drivers of the tractor's presence. Remember that roadways are primarily designed for automotive drivers and most drivers will not be looking out for you, therefore, you must look out for them. Check your side view mirrors frequently and remember that vehicles will approach quickly because of the tractor's slower speed. Be extremely cautious when the piece of equipment that you are towing is wider than the tractor tire width and/or extends beyond your lane of the road. OPS-BL-0003str



Only tow the Implement behind a properly sized and equipped Tractor which exceeds the weight of the Implement by at least 20%. DO NOT tow the Implement behind a truck or other type of vehicle. Never tow the Implement and another Implement connected in tandem. Never tow the Implement at speeds over 20 MPH. (STI-06)str



Never allow children or other persons to ride on the Tractor or Implement. Falling off can result in death or serious injury. (SG-10)str



Make certain that the "Slow Moving Vehicle" (SMV) sign is installed in such a way as to be clearly visible and legible. When transporting the Equipment use the Tractor flashing warning lights and follow all local traffic regulations. (SG-6)str

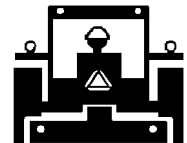

# OPERATION

## OPERATION

The SMV (Slow-Moving Vehicle) emblem is universal symbol used to alert drivers of the presence of equipment traveling on roadways at a slow speed. SMV signs are a triangular bright orange with reflective red trim for both easy day and night visibility. Make sure the SMV sign is clean and visible from the rear of the unit before transporting the tractor and implement on a public roadway. Replace the SMV emblem if faded, damaged, or no longer reflective. OPS-U- 0020str



Make sure that all tractor flashing warning lights, headlights, and brake/tail lights are functioning properly before proceeding onto public roads. While newer model tractors have plenty of lighting to provide warning signals and operating lighting, most older models are only equipped with operating lights. Consult an authorized tractor dealer for lighting kits and modifications available to upgrade the lighting on older tractor models. OPS-U- 0021str



When operating on public roads, have consideration for other road users. Pull to the side of the road occasionally to allow all following traffic to pass. Do not exceed the legal speed limit set in your country for agricultural tractors. Always stay alert when transporting the tractor and implement on public roads. Use caution and reduce speed if other vehicles or pedestrians are in the area.

Reduce speed before turning or applying the brakes. Ensure that both brake pedals are locked together when operating on public roads. OPS-U- 0023 str



# OPERATION

## **14.2 Hauling the Tractor and Implement**

Before transporting a loaded tractor and implement, measure the height and width dimensions and gross weight of the complete loaded unit. Ensure that the load will be in compliance with the legal limits set for the areas that will be traveled through. OPS-U- 0024str



Use adequately sized and rated trailers and equipment to transport the tractor and implement. Consult an authorized dealer to determine the proper equipment required. Using adequately sized chains, heavy duty straps, cables and/or binders, securely tie down both the front and rear of the tractor utilizing the proper tie down locations as specified by the tractor manufacturer. OPS-U-0025 str



Arrange the chains so that when tightened, the chains are pulling downward and against themselves. Carefully tighten the securing chains or other fasteners using boomers or binders to apply maximum tension. Use extreme care when attaching and removing the securing devices as the extreme tension involved when released has the potential to inflict serious injury.

While hauling the tractor and implement, make occasional stops to check that the tractor and implement have not moved or shifted and that the securing chains have maintained tension. If during transport a hard braking, sharp turning, or swerving action was performed, stop at the next safe location to inspect the security of the load. OPS-U-0026str





# **MAINTENANCE SECTION**

Maintenance Section 5-1

# MAINTENANCE

## GENERAL MAINTENANCE



Make certain that you wear gloves and safety glasses when performing maintenance.

1. Grease all grease fittings and lubrication points before each use.
2. Inspect the implement for any worn or damaged parts and replace with a genuine Rhino part.
3. Make sure all safety decals are intact and legible.
4. Check unit for cracks and chips and repair if necessary. Consult your Rhino dealer before any repair is made. Any unauthorized repairs will void the warranty
5. Keep tires inflated to the proper specification found in this manual if implement is equipped with tires.
6. Check all bolt and nuts to insure they are properly torqued. Consult the torque chart found in this manual for torque values.
7. Repack transport wheels, gauge wheels and coulter bearings yearly!

MAINTENANCE

## PROPER TORQUE FOR FASTENERS

The chart lists the correct tightening torque for fasteners. When bolts are to be tightened or replaced, refer to this chart to determine the grade of bolts and the proper torque except when specific torque values are assigned in manual text.

Recommended Torque in Foot Pounds Unless Otherwise Stated in the Manual\*

**NOTE:** *These values apply to fasteners as received from supplier, dry or when lubricated with normal engine oil. They do not apply if special graphited or molydisulphide greases or other extreme pressure lubricants are used. This applies to both UNF fine and UNC coarse threads.*



# MAINTENANCE

MAINTENANCE

## TORQUE SPECIFICATIONS - DRY TORQUE

Proper torque for American fasteners.  
Recommended Torque in Foot Pounds (Newton Meters).\*

### AMERICAN Bolt Head Markings

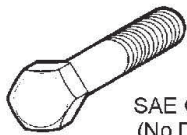

SAE Grade 2  
(No Dashes)

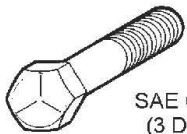

SAE Grade 5  
(3 Dashes)

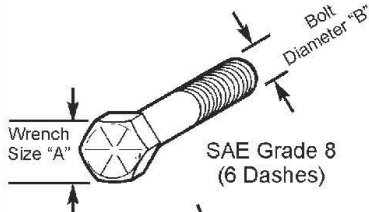

SAE Grade 8  
(6 Dashes)

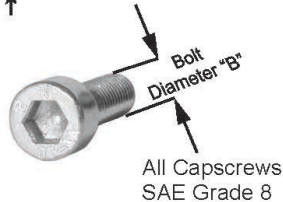

WRENCH SIZE (IN.) "A"	BOLT DIAMETER (IN.) "B" AND THREAD SIZE	SAE GRADE 2	SAE GRADE 5	SAE GRADE 8
7/16	1/4 - 20 UNC	6 (7)	8 (11)	12 (16)
7/16	1/4 - 28 UNF	6 (8)	10 (13)	14 (18)
1/2	5/16 - 18 UNC	11 (15)	17 (23)	25 (33)
1/2	5/16 - 24 UNF	13 (17)	19 (26)	27 (37)
9/16	3/8 - 16 UNC	20 (27)	31 (42)	44 (60)
9/16	3/8 - 24 UNF	23 (31)	35 (47)	49 (66)
5/8	7/16 - 14 UNC	32 (43)	49 (66)	70 (95)
5/8	7/16 - 20 UNF	36 (49)	55 (75)	78 (106)
3/4	1/2 - 13 UNC	49 (66)	76 (103)	106 (144)
3/4	1/2 - 20 UNF	55 (75)	85 (115)	120 (163)
7/8	9/16 - 12 UNC	70 (95)	109 (148)	153 (207)
7/8	9/16 - 18 UNF	79 (107)	122 (165)	172 (233)
15/16	5/8 - 11 UNC	97 (131)	150 (203)	212 (287)
15/16	5/8 - 18 UNF	110 (149)	170 (230)	240 (325)
1-1/8	3/4 - 10 UNC	144 (195)	266 (360)	376 (509)
1-1/8	3/4 - 16 UNF	192 (260)	297 (402)	420 (569)
1-5/16	7/8 - 9 UNC	166 (225)	430 (583)	606 (821)
1-5/16	7/8 - 14 UNF	184 (249)	474 (642)	668 (905)
1-1/2	1 - 8 UNC	250 (339)	644 (873)	909 (1232)
1-1/2	1 - 12 UNF	274 (371)	705 (955)	995 (1348)
1-1/2	1 - 14 UNF	280 (379)	721 (977)	1019 (1381)
1-11/16	1-1/8 - 7 UNC	354 (480)	795 (1077)	1288(1745)
1-11/16	1-1/8 - 12 UNF	397 (538)	890 (1206)	1444 (1957)
1-7/8	1-1/4 - 7 UNC	500 (678)	1120 (1518)	1817 (2462)
1-7/8	1-1/4 - 12 UNF	553 (749)	1241 (1682)	2013 (2728)
2-1/16	1-3/8 - 6 UNC	655 (887)	1470 (1992)	2382 (3228)
2-1/16	1-3/8 - 12 UNF	746 (1011)	1672 (2266)	2712 (3675)
2-1/4	1-1/2 - 6 UNC	870 (1179)	1950 (2642)	3161 (4283)
2-1/4	1-1/2 - 12 UNF	979 (1327)	2194 (2973)	3557 (4820)

### METRIC

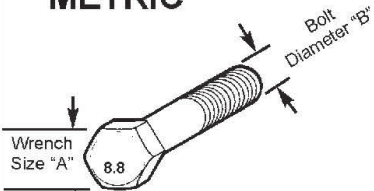

Numbers appearing on bolt heads indicate ASTM class.

Proper torque for Metric fasteners.  
Recommended torque in Foot Pounds (Newton Meters).\*

WRENCH SIZE (mm) "A"	BOLT DIA. (mm) "B"	ASTM 4.6	ASTM 8.8	ASTM 9.8	ASTM 10.9
8	5	1.8 (2.4)		5.1 (6.9)	6.5 (8.8)
10	6	3 (4)		8.7 (12)	11.1 (15)
13	8	7.3 (10)		21.1 (29)	27 (37)
16	10	14.5 (20)		42 (57)	53 (72)
18	12	25 (34)	74 (100)	73 (99)	93 (126)
21	14	40 (54)	118 (160)	116 (157)	148 (201)
24	16	62 (84)	167 (226)	181 (245)	230 (312)
30	20	122 (165)	325 (440)		449 (608)
33	22		443 (600)		611 (828)
36	24	211 (286)	563 (763)		778 (1054)
41	27		821 (1112)		1138 (1542)
46	30	418 (566)	1119 (1516)		1547 (2096)

\*Use 75% of the specified torque value for plated fasteners. Use 85% of the specified torque values for lubricated fasteners.

Mnt-B-0005





## TO THE OWNER/OPERATOR/DEALER

To keep your implement running efficiently and safely, read your manual thoroughly and follow these directions and the Safety Messages in this Manual. The Table of Contents clearly identifies each section where you can easily find the information you need.

The OCCUPATIONAL SAFETY AND HEALTH ACT (1928.51 Subpart C) makes these minimum safety requirements of tractor operators:

### REQUIRED OF THE OWNER:

1. Provide a Roll-Over-Protective Structure that meets the requirements of this Standard; and
2. Provide Seat belts that meet the requirements of this paragraph of this Standard and SAE J4C; and
3. Ensure that each employee uses such Seat belt while the tractor is moving; and
4. Ensure that each employee tightens the Seat belt sufficiently to confine the employee to the protecte-darea provided by the ROPS

### REQUIRED OF THE OPERATOR:

1. Securely fasten seat belt if the tractor has a ROPS.
2. Where possible, avoid operating the tractor near ditches, embankments, and holes.
3. Reduce speed when turning, crossing slopes, and on rough, slick, or muddy surfaces.
4. Stay off slopes too steep for safe operation.
5. Watch where you are going - especially at row ends, on roads, and around trees.
6. Do not permit others to ride.
7. Operate the tractor smoothly - no jerky turns, starts, or stops.
8. Hitch only to the drawbar and hitch points recommended by the tractor manufacturer.
9. When the tractor is stopped, set brakes securely and use park lock, if available.

**X** Keep children away from danger all day, every day...

**X** Equip tractors with rollover protection (ROPS) and keep all machinery guards in place...

**X** Please work, drive, play and live each day with care and concern for your safety and that of your family and fellow citizens.



**BUSH HOG<sup>®</sup>**

**SUB SOILER  
SS1**

---

SS1 Sub Soiler 09/22  
Printed U.S.A

P/N 50072474