



BUSH HOG®

RMB 1445

REAR MOUNT BOOM MOWER

Published 08/22

Part No. 50068815

OPERATOR'S MANUAL



This Operator's Manual is an integral part of the safe operation of this machine and must be maintained with the unit at all times. **READ, UNDERSTAND, and FOLLOW** the Safety and Operation Instructions contained in this manual before operating the equipment. *C01-Cover_B str*

Important Operating and Safety Instructions are found in the Mower Safety Video that can be instantly accessed on the internet at: www.algqr.com/bve

Safety Video



www.algqr.com/bve



BC-0004-A

BUSH HOG®

2501 Griffin Ave.
Selma, AL 36703
334-874-2700
www.bushhog.com

Bush Hog Web Page



www.algqr.com/bwe

¡ATENCIÓN!
LEA EL INSTRUCTIVO



Si No Lee Ingles, Pida
Ayuda a Alguien
Que Se Lo Lea Para Que le
Traduzca Las
Medidas de Seguridad

**A™ MEMBER OF THE
ALAMO GROUP**
ALWAYS ON THE CUTTING EDGE®

! PERIGO	! GEFAHR
<p>Caso você não leia inglês: antes de operar o equipamento, peça para alguém traduzir as mensagens de segurança ou visite a web e obtenha tais mensagens ou os decalques traduzidos.</p>	<p>Falls Sie nicht Englisch sprechen: Bevor Sie die Geräte in Betrieb nehmen, bitten Sie eine Englisch sprechende Person darum, Ihnen die Sicherheitsmeldung zu übersetzen, oder besuchen Sie die Website; dort finden Sie übersetzte Aufkleber und Sicherheitsmeldungen.</p>
<p>Manual do Operador</p>   <p>www.algqr.com/bbp</p>	<p>Benutzerhandbuch</p>   <p>D825 www.algqr.com/bbg</p>

! PERIGO	! GEFAHR
<p>Caso você não leia inglês: antes de operar o equipamento, peça para alguém traduzir as mensagens de segurança ou visite a web e obtenha tais mensagens ou os decalques traduzidos.</p>	<p>Falls Sie nicht Englisch sprechen: Bevor Sie die Geräte in Betrieb nehmen, bitten Sie eine Englisch sprechende Person darum, Ihnen die Sicherheitsmeldung zu übersetzen, oder besuchen Sie die Website; dort finden Sie übersetzte Aufkleber und Sicherheitsmeldungen.</p>
<p>Manual do Operador</p>   <p>www.algqr.com/bbp</p>	<p>Benutzerhandbuch</p>   <p>D825 www.algqr.com/bbg</p>

Safety Video



www.algqr.com/bve

Operator's & Parts Manuals



www.algqr.com/bpm

General Safety



www.algqr.com/bme



www.algqr.com/bve

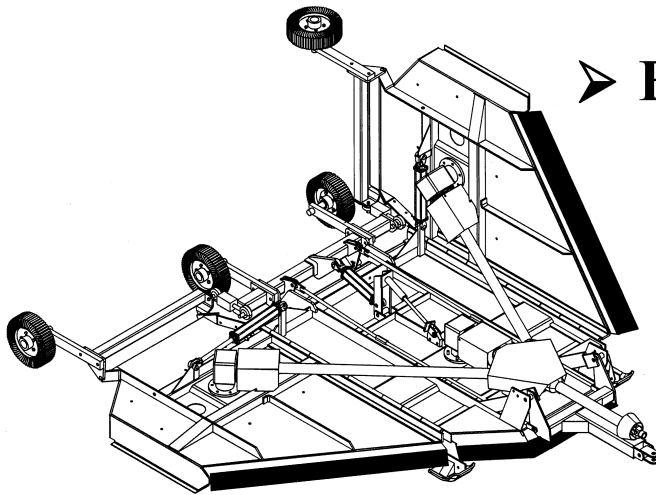

➤ **BE SAFE!**

➤ **BE ALERT!**

➤ **BE ALIVE!**

➤ **BE TRAINED
before operating
the Mower!**



Safety Training Makes the Difference

In order to reduce accidents and enhance the safe operation of mowers, *Bush Hog*, in cooperation with other industry manufacturers has developed the AEM/FEMA Industrial and Agricultural Mower Safety Practices video and guide book.

The video will familiarize and instruct mower-tractor operators in safe practices when using industrial and agricultural mowing equipment. It is important that Every Mower Operator be educated in the operation of their mowing equipment and be able to recognize the potential hazards that can occur while operating a mower. This video, along with the mower operator's manual and the warning messages on the mower, will significantly assist in this important education.

Your Authorized *Bush Hog* Dealer may have shown this video and presented you a DVD Video when you purchased your mower. If you or any mower operator have not seen this video, **Watch the Video, Read this Operator's Manual, and Complete the Video Guidebook** before operating your new mower. If you do not understand any of the instructions included in the video or operator's manual or if you have any questions concerning safety of operation, contact your supervisor, dealer or *Bush Hog*.

If you would like a VHS video tape of the video, please mail AEMVideo@alamo-group.com or Fax AEM VHS Video at (830) 372-9529 or mail in a completed copy of the form on the back of this page to AEM VHS Video 1502 E Walnut Street, Seguin, TX 78155. and request the VHS video version. Please include your name, mailing address, mower model and serial number.

Every operator should be trained for each piece of equipment (Tractor and Mower), understand the intended use, and the potential hazards before operating the equipment.

The information and material listed above along with this Operator's Manual can assist you in meeting the OSHA requirement for annual operator training.

OSHA TRAINING REQUIREMENTS

The following training requirements have been taken from Title 29, Code of Federal Regulations Part 1928.57 (a)(6). www.osha.gov

Operator Instructions. At the time of initial assignment and at least annually thereafter, the employer shall instruct every employee who operates an agricultural tractor or implement in the safe operating practices and servicing of equipment with which they are or will be involved, and of any other practices dictated by the work environment.

Bush Hog will provide one (1) AEM Mower Safety Practices Video

Please Send Me:

- VHS Format – AEM/FEMA Mower Operator Safety Video
- DVD Format – AEM/FEMA Mower Operator Safety Video
- Mower Operator's Manual
- AEM Mower Operator's Safety Manual

Requester Name: _____ Phone: _____

Requester Address: _____

City: _____

State: _____

Zip Code: _____

Mower Model: _____ Serial Number: _____

Date Purchased: _____ Dealer Salesperson: _____

Dealership Name: _____ Dealership Location: _____

Mail to:

AEM Video Services
1502 E. Walnut Street
Seguin, TX 78155

Or Fax to:

(830) 372-9529

Or email to:

AEMVideo@alamo-group.com

To the Owner/Operator/Dealer

This Operator's Manual is an integral part of the safe operation of this machine and must be maintained with the implement at all times. A Manual canister is provided on the implement where this manual can be properly stored. If you lose or damage this manual a free replacement manual can be obtained from an authorized Bush Hog dealer or by downloading the manual from the Bush Hog website www.bushhog.com

BEFORE YOU START! READ, UNDERSTAND, and FOLLOW the information provided in this manual, the AEM Mower Safety manual and the power unit operator's manual carefully to learn how to operate and service your machine properly. Failure to do so could result in personal injury to you and bystanders. All implements with moving parts are potentially hazardous. Every effort has been made to ensure that the machine is safe but operators must avoid engaging in unsafe practices and follow the written instructions provided. The manufacturer has designed this implement to be used with all its safety equipment properly attached to minimize the chance of accidents.

SAFETY FIRST. Completely read and understand the safety section of this manual before operating this equipment. Do not allow anyone to operate this equipment who has not fully read and understood this manual. Contact your Dealer to explain any instructions that you do not fully understand.

The care you give your Bush Hog will greatly determine your satisfaction with its performance and its service life. Carefully read and follow the instructions in this manual to provide you with a thorough understanding of your new implement and its intended use and service requirements.

Replacement Parts information is located in a separate Parts Manual. Bush Hog mowers use balanced and matched system components for blade carriers, blades, cuttershafts, knives, knife hangers, rollers, drivetrain components, and bearings. These parts are made and tested to Bush Hog specifications. Non-genuine "will fit" parts do not consistently meet these specifications. The use of "will fit" parts may reduce mower performance, void warranties, and present a safety hazard. Use genuine Bush Hog mower parts for economy and safety.

For future reference, record your Bush Hog product model number and serial number.

Dealer		Telephone		Model Number	
Owner		Purchase Date		Serial Number	

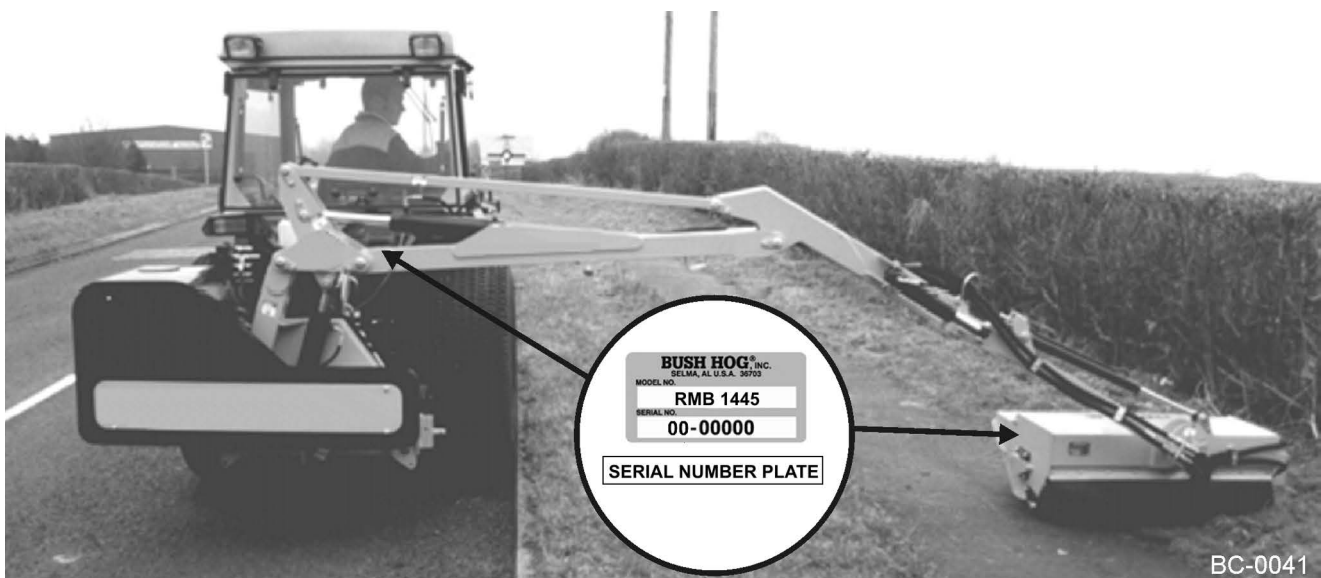

DEALER to CUSTOMER Pre-Delivery / Operation Instructions

Dealer should inform the Purchaser of this product of Warranty terms, provisions, and procedures that are applicable. Dealer should also inform the Purchaser to review the contents of the Operator's Manual including safety equipment, safe operation and maintenance, to review the Safety Signs on the implement (and tractor if possible) and of Purchaser's responsibility to train his/her operators in safe operation procedures.

- **IMPLEMENTS:** I have explained that Deflectors, Chain Guards, or Solid Skirts must be installed and maintained in good repair
- **DRIVELINES:** I have made certain that all driveline, gearbox, and other shields are in good repair and fastened securely in place to prevent injuries from entanglement or thrown objects.
- **HYDRAULIC MACHINES:** I have explained the necessity of using clean hydraulic oil, changing filters as instructed, stopping leaks, damage caused by operating with over-heated oil, caring for hoses, using hoses of proper rating, maintaining the specified operating pressure and the potential hazard of oil's penetrating the skin.
- **FOLDING-TYPE IMPLEMENTS:** I have explained that it is not possible to guard against thrown objects when the head is lifted off ground and that operator is responsible to watch out for persons in the area. I have explained that the lifted mower head or boom can contact overhead obstructions with damage to cables and telephone lines and possible injury. I have explained that the extended head or boom or retracted boom can contact power lines with resulting electrocution, injury or death and that operator is responsible for keeping clear of such hazards.

PRE-DELIVERY SERVICE CHECK AND ADJUST OR LUBRICATE AS REQUIRED

See Operator's Manual for Details

Inspection Performed - Warranty and Safety Procedures Explained - Installation Complete

LUBRICATION & HYDRAULICS

- Gearbox (Oil Levels)
- Hydraulic Oil Level (External Tank)
- Tractor Hydraulic Oil Level
- Hydraulic Hoses (Not Kinked Tighten Connections)
- Front Pump Drive (Assembly Is Tight And Shaft Properly Aligned)

MOWER

- Spindle And Motor Bolts Properly Torqued
- Spindle Oil Level
- Blade Carrier Bolts Properly Torqued/Retaining Pin In Place
- Mower Cutting Height And Level Adjusted
- Cutting Shaft Bearings Lubricated
- All Hardware Properly Torqued
- Tire and Air Pressure/Lug Nuts (Correct Torque)
- Wheel Bearings (Check, Grease, and Pre-load)

ATTACHMENTS & INSTALLATION

- Deflectors Front And Rear
- Shredding Attachments
- Correct Blade Rotation Direction
- Axle Arms And Beams
- Tongue And Control Rods (Installed And Adjusted)
- All Bolts - Pins And Nuts (Proper Torque)

MOWER TO TRACTOR CONNECTIONS

- Draw Bar Length (Check And Set)
- A-Frame Pivot & Links
- Control Rods (Adjusted Equal)
- Axle Height (Adjusted)
- Cutting Height (Adjust)
- Mount Kit - Pre-Operation Check Complete
- Mower Wing (Adjust Level With The Center)
- Mower Wing (Check For Proper Raising Operation)
- C.V. Drivelines (Check Max Turn Radius)
- Pull Type Hitch (Height Adjustment)
- Mounting Hardware Properly Torqued

SAFETY ITEMS

- Protective Shields (Operation And Installation)
- Driveline Clutch (Torque Limiter) (Adjust And Run In)
- Safety Decals (Installed)
- Operator's Manual (Supplied)
- Tractor PTO Shield (Installed)
- S.M.V. Emblem (Installed If Needed)
- Tongue Jack (Installation and Operation)
- Safety Tow Chain (Installed)
- ADMA Driveline Safety Manual Supplied
- AEM Mower Safety Manual (Supplied in Canister)
- AEM Mower Safety Video has been shown to Purchaser

Table of Contents

SAFETY SECTION	1 - 1
SAFETY MESSAGES	1 - 2
OPERATOR SAFETY	1 - 3
CRUSHING HAZARDS	1 - 4
CONNECTING OR DISCONNECTING IMPLEMENT SAFETY	1 - 5
THROWN OBJECT HAZARDS	1 - 6
RUN OVER HAZARDS	1 - 8
PTO ENTANGLEMENT HAZARDS	1 - 9
MOWER BLADE CONTACT HAZARDS	1 - 10
HIGH PRESSURE OIL LEAK HAZARDS	1 - 11
ELECTRICAL & FIRE HAZARDS	1 - 12
TRANSPORTING HAZARDS	1 - 13
HAZARDS WITH MAINTENANCE OF IMPLEMENT	1 - 14
PARTS INFORMATION	1 - 16
DECAL LOCATION	1 - 17
DECAL DESCRIPTION	1 - 21
FEDERAL LAWS AND REGULATIONS	1 - 31
INTRODUCTION SECTION	2 - 1
FEATURES	2 - 3
ATTENTION OWNER/OPERATOR	2 - 4
BUSH HOG LIMITED WARRANTY	2 - 5
ASSEMBLY SECTION	3 - 1
TRACTOR SELECTION	3 - 2
Hitch Requirement	3 - 2
PTO TYPE	3 - 2
PTO Shaft	3 - 2
Horsepower Requirement	3 - 2
Tractor Weight	3 - 2
Check Chains/Stabilizers	3 - 2
Stability Requirements	3 - 2
Tractor Operator Station	3 - 2
Ballast	3 - 2
DEALER SETUP INSTRUCTIONS	3 - 3
STABILIZER ATTACHMENT	3 - 3
TOP LINK ATTACHMENT	3 - 4
DRIVELINE ATTACHMENT	3 - 5
REMOVE TRANSPORT STRAP	3 - 6
HOSE ROUTING	3 - 7
FINAL ASSEMBLY CHECKS	3 - 7
OIL REQUIREMENTS	3 - 7
Tank	3 - 7
Gearbox	3 - 8

Table of Contents

FITTING CONTROL UNIT IN CAB	3 - 9
RUNNING UP PROCEDURE	3 - 9
RMB 1445 With Flail Head ONLY	3 - 9
REMOVAL FROM TRACTOR	3 - 10
OPERATION SECTION	4 - 1
STANDARD SPECIFICATIONS	4 - 3
OPERATOR REQUIREMENTS	4 - 4
TRACTOR REQUIREMENTS	4 - 5
ROPS and Seat Belt	4 - 5
Operator Thrown Object Protection	4 - 5
Tractor Lighting and SMV Emblem	4 - 6
Tractor Ballast	4 - 6
Tractor Safety Devices	4 - 6
Tractor Horsepower	4 - 7
3-Point Hitch	4 - 7
Hydraulics	4 - 7
Front End Weight	4 - 7
Power Take Off (PTO)	4 - 7
GETTING ON AND OFF THE TRACTOR	4 - 8
Boarding the Tractor	4 - 8
Dismounting the Tractor	4 - 9
STARTING THE TRACTOR	4 - 9
PRE-OPERATION INSPECTION AND SERVICE	4 - 11
Tractor Pre-Operation Inspection and Service	4 - 11
Boom Unit Pre-Operation Inspection and Service	4 - 12
TRACTOR PRE-OPERATION INSPECTION	4 - 17
BUSH HOG BOOM MOWER PRE-OPERATION INSPECTION	4 - 18
MACHINE CONTROLS	4 - 19
ROTOR CONTROLS	4 - 20
Angle Float	4 - 21
Engaging the Drive	4 - 21
Rotor Operating Speed	4 - 21
Forward Speed	4 - 21
Tractor Position	4 - 22
Operating Speed	4 - 22
Parallel Motion Geometry	4 - 22
Working Close In and High	4 - 22
Breakaway Action	4 - 22
High Voltage Cables	4 - 23
Cutting Sequence	4 - 24
Grass Cutting	4 - 25
DRIVING THE TRACTOR AND IMPLEMENT	4 - 26

Table of Contents

Starting the Tractor	4 - 27
Brake and Differential Setting	4 - 28
Driving the Tractor and Boom	4 - 29
OPERATING THE TRACTOR AND IMPLEMENT	4 - 29
OPERATING INSTRUCTIONS	4 - 30
Foreign Debris Hazards.....	4 - 31
Bystanders/Passersby Precautions	4 - 32
Engaging the Power Take Off (PTO).....	4 - 32
Operating Speed and Ground Speed	4 - 33
Operating the Mower	4 - 33
Operating the Attached Mower Heads	4 - 35
Shutting Down the Attached Head	4 - 36
TRACTOR, BOOM, AND ATTACHED HEAD STORAGE	4 - 36
TRANSPORTING THE TRACTOR AND IMPLEMENT	4 - 37
Transporting on Public Roadways	4 - 38
TROUBLESHOOTING GUIDE	4 - 41
MAINTENANCE SECTION	5 - 1
HAZARDS WITH MAINTENANCE OF IMPLEMENT.....	5 - 2
PARTS INFORMATION	5 - 4
LUBRICATION INFORMATION.....	5 - 4
PTO SHAFT	5 - 5
PTO Lubrication	5 - 6
CUTTING PTO SHAFT	5 - 6
P.T.O. GEARBOX.....	5 - 8
HYDRAULIC SYSTEM	5 - 8
Oil Supply	5 - 8
Filtration Maintenance	5 - 8
HYDRAULIC HOSES	5 - 9
Hose Replacement.....	5 - 9
Hose Warranty.....	5 - 9
CABLES.....	5 - 10
HOSE CONNECTIONS	5 - 10
CYLINDER ROD MAINTENANCE.....	5 - 10
BOOM CYLINDER REMOVAL AND REPLACEMENT INSTRUCTIONS.....	5 - 11
HYDRAULIC COMPONENT MAINTENANCE SCHEDULE	5 - 12
PROPER TORQUE FOR FASTENERS	5 - 12
FLAILHEAD	5 - 14
Flail Head Inspection	5 - 15
Blade Pins and D-Ring Inspection	5 - 16
Flail Axe Blade Inspection	5 - 17
Flail Axe Blade Bolt Inspection	5 - 18

SAFETY SECTION

Safety Section 1-1

SAFETY

SAFETY MESSAGES

A careful operator is the best operator. Safety is of primary importance to the manufacturer and should be to the owner/operator. Most accidents can be avoided by being aware of your equipment, your surroundings, and observing certain precautions. The first section of this manual includes a list of Safety Messages that, if followed, will help protect the operator and bystanders from injury or death. Read and understand these Safety Messages before assembling, operating, or servicing this Implement. This equipment should only be operated by those persons who have read the manual, who are responsible and trained, and who know how to do so responsibly.



The Safety Alert Symbol combined with a Signal Word, as seen below, is used throughout this manual and on decals which are attached to the equipment. The Safety Alert Symbol means: "ATTENTION! BECOME ALERT! YOUR SAFETY IS INVOLVED!" The Symbol and Signal Word are intended to warn the owner/operator of impending hazards and the degree of possible injury faced when operating this equipment.

Practice all usual and customary safe working precautions and above all--remember safety is up to YOU. Only YOU can prevent death or serious injury from unsafe practices.



Indicates an imminently hazardous situation that, if not avoided, WILL result in DEATH OR VERY SERIOUS INJURY.



Indicates an imminently hazardous situation that, if not avoided, COULD result in DEATH OR SERIOUS INJURY.



Indicates an imminently hazardous situation that, if not avoided, MAY result in MINOR INJURY.



Identifies special instructions or procedures that, if not strictly observed, could result in damage to, or destruction of the machine, attachments or the environment.

NOTE: Identifies points of particular interest for more efficient and convenient operation or repair.

READ, UNDERSTAND, and FOLLOW the following Safety Messages. Death or serious injury may occur unless care is taken to follow the warnings and instructions stated in this Manual and in the Safety Messages on the implement. Always follow the instruction in this manual and use good common sense to avoid hazards.



Pictographs are used throughout this manual to help bring your visual attention to safety issues.

SAFETY HAZARD	SAFETY AVOIDANCE	SAFETY PREVENTION
<p>Pictograph surrounded by a triangle indicates a Safety Hazard that must be avoided. Example:</p> <p>Equipment contacting overhead electrical lines</p>	<p>Pictograph in a circle with blue or black background, by itself or inside a box, indicates an avoidance procedure or action that should be followed to prevent injuries. Example:</p> <div style="display: flex; justify-content: space-around;"> <div style="text-align: center;"> <p>Wear safety footwear.</p> </div> <div style="text-align: center;"> <p>Always shut off engine and remove key before working on equipment.</p> </div> </div>	<p>A circle with a slash through it indicates an action that is prohibited. Example:</p> <div style="text-align: center;"> <p>No Smoking</p> </div>

NOTE: If you want a translation of this safety section in one of the following Languages, please contact: Translations at 1502 E. Walnut Street Seguin, TX 78155; Fax: (830) 372-9529; Safety Section Translations are available in Spanish, Portuguese, French, German, Russian. GS01str

SAFETY

SAFETY

OPERATOR SAFETY

				
Read and understand Operator's Manual	Always wear Safety Glasses with side shields marked to comply with ANSI Z87	Wear Hard Hat Safety Shoes	Never use Drugs or Alcohol when operating equipment	Wear Safety Vest when operating on or near roads



TO AVOID DEATH OR SERIOUS INJURY DO THE FOLLOWING:

- **READ, UNDERSTAND and FOLLOW** Operator's Manual instructions, Warnings and Safety Messages.
- **WEAR SAFETY GLASSES WITH SIDE SHIELDS MARKED TO COMPLY WITH ANSI Z87**, safety shoes, hard hat, hearing protection and gloves when operating or repairing equipment.
- **WEAR** appropriate breathing respirator when operating in dusty conditions to avoid respiratory diseases.
- **DO NOT WEAR** loose clothing or jewelry to avoid rotating parts entanglement injury.
- **DO NOT USE DRUGS or ALCOHOL** before or while operating equipment.
- **DO NOT ALLOW** anyone to operate equipment under the influence of drug or alcohol.
- **CONSULT** medical professional for medication impairment side effects.
- **STAY CLEAR** of hot surfaces such as Mufflers, hydraulic pumps, valves and tanks.
- **STAY ALERT**, prolonged operation can cause fatigue, STOP and REST.

GENERAL OPERATING SAFETY

VISIBILITY CONDITIONS WHEN MOWING:

- **OPERATE IN DAYLIGHT** or with lights that gives at least 100 yards clear visibility.
- **BE ABLE TO SEE** and identify passersby, steep slopes, ditches, drop-offs, overhead obstructions, power lines, debris and foreign objects.
- Avoid backing up while mowing, vision may be limited, severe damage or injury can occur.
- **DO NOT** run tractor in enclosed building without adequate exhaust ventilation.

GROUND SPEED WHEN MOWING:

- **NORMAL SPEED** range is between 1 to 2 mph (1-3 kph).
- **ADJUST MOWING SPEED** for terrain conditions and grass type, density and cut height.
- **REDUCE MOWING SPEED** when near steep slopes, ditches, drop-offs, overhead obstructions, power lines and to avoid debris and foreign objects.

TRACTOR and MOWER:

- **DO NOT** operate the tractor or mower unless the equipment is maintained and operating properly.
- **DISCONTINUE OPERATION** if tractor or mower electrical and hydraulic controls do no function properly.
- **DISCONTINUE OPERATION** of the tractor if the braking or steering systems do not function properly.
- **DO NOT** operate the tractor or mower if there are any hydraulic leaks.

INSECT INFESTATION:

- **DO NOT** operate in areas where bees or insects may attack unless you **WEAR PROTECTIVE CLOTHING** or use enclosed tractor cab.

PTO SPEED:





- **DO NOT EXCEED IMPLEMENT RATED PTO SPEED**
- **AVOID** exceeding rated PTO speeds that may result in broken drivelines or blade failures.

SAFETY SIGNS:

- **REPLACE** missing, damaged or unreadable safety signs immediately. *PN OSBM-01str*

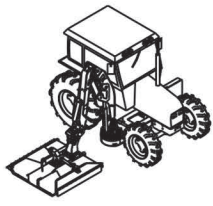
SAFETY

CRUSHING HAZARDS

				
Crushing injury from roll over	Use Cab Tractor With Boom Mowers	Always wear seatbelt	Pinch Point Hazard Keep Hands and body parts clear of pinch points	Crushing injury from boom or mower head falling

⚠ DANGER

TO AVOID DEATH OR SERIOUS INJURY FROM FALLING OFF TRACTOR, EQUIPMENT RUN OVER, ROLLOVER AND CRUSHING BY FALLING WING OR IMPLEMENT:

- USE ROPS and SEAT BELT equipped tractors for mowing operations.
- KEEP ROPS lock in up position.
- ALWAYS BUCKLE UP seat belt when operating tractor and equipment.
- ONLY OPERATE tractor and equipment while seated in tractor seat.

WHEN RAISING BOOM MOWER:

- Raise or lower ONLY WHILE SEATED in tractor seat with seat belt buckled.
- KEEP BYSTANDERS CLEAR of area TO AVOID crushing.
- KEEP sufficient clearance around implement and wings TO AVOID contacting buildings or overhead power lines.

LIFTED Equipment can fall from mechanical or hydraulic failure or inadvertent Control Lever movement.

⚠ WARNING

TO AVOID EQUIPMENT FALLING while working near or under lifted boom, components and Mower Head:

- SECURELY SUPPORT or block up raised equipment, wings and components.
- BLOCK UP and securely support equipment before putting hands, feet or body under raised equipment or lifted components.
- KEEP BYSTANDERS CLEAR of raised boom or mower head until securely blocked up.

WHEN PARKING Implement and Tractor:

- LOWER Mower Head to the ground or BLOCK lifted parts before leaving equipment.
- NEVER leave implement unattended in a raised position.

⚠ WARNING





TO AVOID CHILDREN FALLING OFF OR BEING CRUSHED BY EQUIPMENT:

- NEVER ALLOW children to play on or around Tractor or Implement.
- DO NOT operate without operator CAB or OVERHEAD protection. Falling limbs and debris can cause injuries. *PN CHBM-01str*

SAFETY

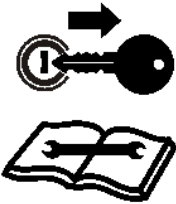
SAFETY

CONNECTING OR DISCONNECTING IMPLEMENT SAFETY

			
<p>Stop Tractor Remove Key Read Manual</p>	<p>Crushing Hazard Do Not get under boom when connecting mower head to boom</p>	<p>Stability Hazard Ensure 20% of tractor weight is on front wheels</p>	<p>Stability Hazard Ensure 1500lbs down force on left tire with boom extended</p>



TO AVOID DEATH OR SERIOUS INJURY FROM BEING CRUSHED BY TRACTOR OR IMPLEMENT:

WHEN connecting mower head to the boom:

- KEEP BYSTANDERS AWAY from tractor and mower.
- Ensure there is enough room to lift and swing the boom without hitting objects

BEFORE connecting and disconnecting the mower head or boom:

- STOP TRACTOR ENGINE, place transmission into park, engage parking brake and remove key.

WHEN connecting and disconnecting the mower head or boom:

- DO NOT crawl or walk under raised mower head or boom. (Refer to Instructions in Operation Section)

WHEN CONNECTING IMPLEMENT DRIVELINE: (If equipped)

TO AVOID implement driveline coming loose during operation:

- LUBRICATE yoke spring locking collar to ensure it freely slides on PTO shaft.
- SECURELY seat yoke locking balls in PTO shaft groove.
- PUSH and PULL DRIVELINE on both the tractor and implement PTO SHAFTS to ensure it is SECURELY ATTACHED.

TO AVOID broken driveline during operations:

- CHECK driveline for proper length between PTO shaft and implement gearbox shaft. (Refer to Instructions in Operation Section)
- Drivelines too short can pull apart or disengage.
- Drivelines too long can bottom out.
- Bottoming driveline telescoping assembly will stop sliding and become solid.
- Driveline bottoming can push through support bearings and break off PTO shaft.





CONTACT DEALER if implement driveline does not match Tractor PTO shaft:

- DO NOT USE PTO ADAPTER.
- Using a PTO adapter can cause:
 - Excessive vibration, thrown objects, blade and implement failures by doubling operating speed.
 - Increased working length exposing unshielded driveline areas and entanglement hazards.

PN CDBM-01str

SAFETY

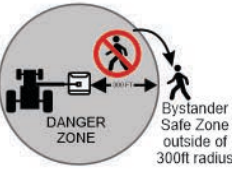
THROWN OBJECT HAZARDS

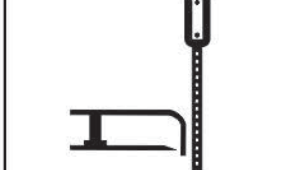
				
Mower Thrown Objects Hazard	Raised Mower Thrown Objects	Keep mower door closed when traffic comes within 300 feet of Danger Zone	Inspect Area remove foreign objects	Do not let blades contact solid objects



ROTARY MOWERS CAN THROW OBJECTS 300 FEET OR MORE UNDER ADVERSE CONDITIONS.

TO AVOID DEATH OR SERIOUS INJURY TO OPERATOR OR BYSTANDERS FROM THROWN OBJECTS:

- KEEP bystanders 300 feet away.

STOP MOWING IF PASSERSBY ARE WITHIN 300 FEET UNLESS:

- All THROWN OBJECT SHIELDING including, Front and Rear Deflectors, Chains Guards, Steel Guards, Bands, Side Skirts and Skid Shoes in place and in good condition when mowing.
- Mower is close and parallel to ground without exposing blades.
- MOWING AREA has been inspected and foreign materials and debris have been removed.
- DO NOT shred or mow loose or previously cut material if BYSTANDERS are within 300 feet.
- PASSERSBY are inside enclosed vehicle.

INSPECT AREA FOR POTENTIAL THROWN OBJECTS BEFORE MOWING:

- REMOVE debris, rocks, wire, cable, metal objects and other foreign material from area.
- Wire, cable, rope, chains and metal objects can be thrown or swing outside deck with great velocity.
- DO NOT allow the mower blades to contact decaying animal carcasses or other hazardous materials. The mower blades could throw hazardous and biologic material out from under mower exposing the operator and bystanders to health risks. Always wear required OSHA approved Personal Protective Equipment (PPE) when cleaning or removing potentially hazardous material from equipment.

MARK objects that cannot be removed.

AVOID these objects when mowing.

HIGH GRASS and WEED AREA INSPECTION:

- INSPECT for and REMOVE any hidden large debris that can be thrown by mower.
- MOW at Intermediate height.
- INSPECT and remove remaining debris.
- MOW at final height.

MOWER THROWN OBJECT SHIELDING:





- KEEP all thrown object shielding including, Front and Rear Deflectors, Chains Guards, Steel Guards, Bands, Side Skirts and Skid Shoes in place and in good condition when mowing.
- DO NOT OPERATE with any thrown object shielding missing, damaged or removed.

RIGHT OF WAY (Highway) MOWING:

- Stop mowing if any bystander comes within 300 feet of the mower.
- No shielding is 100% effective in preventing thrown objects. To Reduce Possibility of Injury:
- MAINTAIN MOWER SHIELDING, side skirts, skid shoes, and blades in good operational condition,
- RAISE CUTTING HEIGHT to 6 INCHES minimum,
- INSPECT AREA thoroughly before mowing to REMOVE potential THROWN OBJECT HAZARDS.
- NEVER ALLOW BLADES to CONTACT SOLID OBJECTS like wire, rocks, post, curbs, guardrails, or ground while mowing. PN TOBM-01str

SAFETY

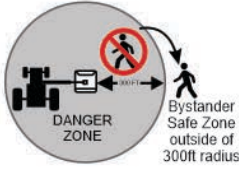
THROWN OBJECTS HAZARDS (CONTINUED)

				
<p>Mower Thrown Objects Hazard</p>	<p>Raised Mower Thrown Objects</p>	<p>Keep mower door closed when traffic comes within 300 feet of Danger Zone</p>	<p>Inspect Area remove foreign objects</p>	<p>Do not let blades contact solid objects</p>

MOWER OPERATION:

- DO NOT exceed mower's rated Cutting Capacity or cut non-vegetative material.
- USE ENCLOSED CABS when two or more mowers are operating in mowing area.
- Do Not mow in areas where bees or insects may attack unless you WEAR PROTECTIVE CLOTHING or use enclosed tractor cab.
- ADJUST mower head close and parallel to ground without exposing blades.
- ADJUST cutting HEIGHT to AVOID BLADE CONTACT with solid objects like wire, rocks, posts, curbs, guard rails and fixed obstructions.
- CLOSE Mower door and stop operating if bystanders come within 300 feet of the mower.
- Keep bystanders out of the Danger zone, which is 300 ft radius from mower. If using spotters make sure they are outside of the 300 ft radius Danger Zone.
- Keep mower door closed when cutting close to the ground.
- Open door only to cut large brush or tree limbs. Close door immediately after cutting limb.
- DO NOT push mower head down onto material to cut it, use the front tips of the mower blades to cut into the material.
- DO NOT operate mower when mower is in transport position.
- STOP MOWING immediately if blades strike heavy objects, fixed structures, metal guard rails and concrete structures:
- BLADES CAN FAIL from impact and objects can be thrown with great velocity.
- INSPECT and REPLACE any damaged blades.

CHECK blade carrier and REPLACE if damaged.

- DO NOT mow in standing water TO AVOID possible BLADE FAILURE.
- AVOID MOWING in reverse.
- STOP PTO and back up mower.
- LOWER mower, engage PTO and mow forward while looking for bystanders who may be behind or to the side of the machine.
- DISENGAGE mower head and wait until BLADES stop rotating before raising mower to transport position.
- DO NOT ENGAGE PTO with mower in transport position.
- STOP mowing when EXCESSIVE VIBRATION occurs:
- STOP PTO and tractor ENGINE.
- INSPECT mower for vibration source.

REPLACE any damaged parts and bent or damaged BLADES. PN TOBM-02 str

SAFETY

SAFETY

RUN OVER HAZARDS

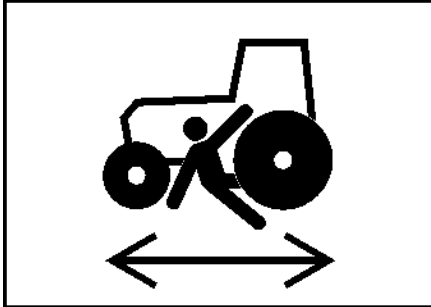

Operator run over hazard

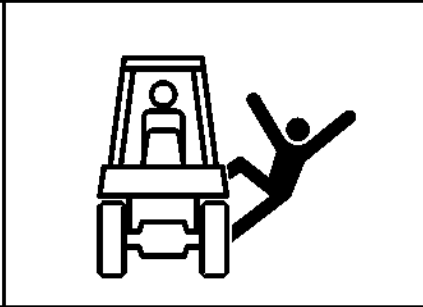

Rider fall off run over hazard

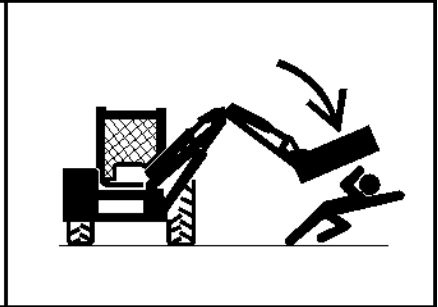

Bystander run over hazard



TO AVOID DEATH OR SERIOUS INJURY FROM FALLING OFF TRACTOR OR EQUIPMENT RUN OVER:

- USE ROPS and SEAT BELT equipped tractors for mowing operations.
- KEEP ROPS locked in UP position.
- ONLY start tractor while seated in tractor seat.
- ALWAYS BUCKLE UP seat belt when operating tractor and equipment.
- ONLY OPERATE tractor and equipment while seated in tractor seat.
- NEVER ALLOW RIDERS on tractor or implement.
- When not mowing stow Boom and Mower head in transport location before moving.

WHEN MOUNTING AND DISMOUNTING TRACTOR:

- ONLY mount or dismount when tractor and moving parts are stopped.
- STOP ENGINE AND PTO, engage parking brake, lower implement, allow all moving parts to stop and remove key before dismounting from tractor. *PN ROBM-01str*

SAFETY

SAFETY

PTO ENTANGLEMENT HAZARDS

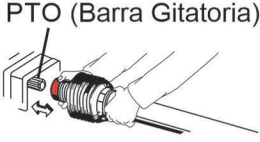
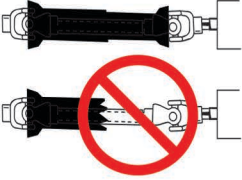
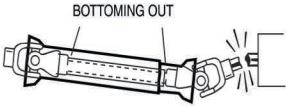
	 <p>PTO (Barra Gitoria)</p>		 <p>BOTTOMING OUT</p>
<p>Entanglement hazard Do Not approach or touch a rotating PTO driveshaft</p>	<p>Make sure PTO shaft is securely attached Do Not Use PTO Adapter</p>	<p>DO NOT Operate if PTO shields are damaged or missing</p>	<p>Make sure PTO shafts are proper length</p>



KEEP AWAY FROM ROTATING DRIVELINES AND ELEMENTS TO AVOID DEATH OR SERIOUS INJURY:

STAY AWAY and **KEEP** hands, feet and body **AWAY** from rotating blades, drivelines and parts until all moving elements have stopped.

- **STOP, LOOK and LISTEN** before approaching the mower to make sure all rotating motion has stopped.
- **ROTATING COMPONENTS CONTINUE to ROTATE** after the PTO is shut off.

PTO SHIELDING:

TO AVOID SERIOUS INJURY OR DEATH FROM ENTANGLEMENT WHEN OPERATING IMPLEMENT:

- **KEEP PTO** shields, integral driveline shields and input shields installed.
- **DO NOT OPERATE** mower without shields and guards in place or missing.
- **REPAIR OR REPLACE** if damage, broken or missing.
- **ALWAYS REPLACE GUARDS** that have been removed for service or maintenance.
- Do Not use PTO or PTO guard as a step.

TO AVOID broken driveline during operations:

- **CHECK** driveline for proper length between PTO shaft and implement gearbox shaft. (Refer to Instructions in Operation Section)
- Drivelines too short can pull apart or disengage.
- Drivelines too long can bottom out.
- Bottoming driveline telescoping assembly will stop sliding and become solid.
- Driveline bottoming can push through support bearings and break off PTO shaft.
- **AVOID** sharp turns or lift mower to heights to cause driveline "knocking".
- Lubricate driveshaft-telescoping components weekly.





CONTACT DEALER if implement driveline does not match Tractor PTO shaft:

- **DO NOT USE PTO ADAPTER.**

Using a PTO adapter can cause excessive vibration, thrown objects, blade and implement failures by doubling operating speed. Increased working length exposing unshielded driveline areas. *PN PE01str*

SAFETY

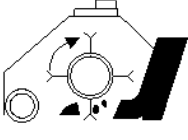
MOWER BLADE CONTACT HAZARDS

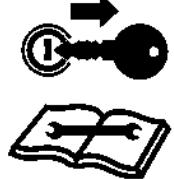
					
Do not put fingers underneath mower	Do not put hands underneath Flail Mower	Do not put foot underneath mower	Do not put foot underneath Flail Mower	Shearing Hazard from Sickle blades	Stop Tractor Remove Key Read Manual



KEEP AWAY FROM ROTATING BLADES TO AVOID DEATH OR SERIOUS INJURY FROM BLADE CONTACT:

- STAY AWAY and KEEP HANDS, FEET and BODY AWAY from rotating blades, drivelines and parts until all moving elements have stopped.
- DO NOT put hands or feet under mower decks.
- STOP rotating BLADES disengage mower switch and PTO and wait for blade to stop rotating before raising mower head.
- DO NOT approach Sickle Bar head until Tractor Engine has been shut off.
- STOP LOOK and LISTEN before approaching the mower to make sure all rotating motion has stopped.



PN MBBM-01str

SAFETY

SAFETY

SAFETY

HIGH PRESSURE OIL LEAK HAZARDS

			
High pressure oil penetrating skin	High pressure oil eroding skin	Using cardboard to check for oil leaks	Tank contents under pressure. Allow oil to cool for at least 5 minutes before slowly removing cap



TO AVOID DEATH OR SERIOUS INJURY FROM HIGH PRESSURE HYDRAULIC OIL LEAKS PENETRATING SKIN:

- DO NOT OPERATE equipment with oil or fuel leaks.
- KEEP all hydraulic hoses, lines and connections in GOOD CONDITION and TIGHT before applying system pressure.
- RELIEVE HYDRAULIC PRESSURE before disconnecting lines or working on the system.
- REMOVE and replace hose if you suspect it leaks. Have dealer test it for leaks.

HIGH PRESSURE FLUID LEAKS CAN BE INVISIBLE.

WHEN CHECKING FOR HYDRAULIC LEAKS AND WORKING AROUND HYDRAULIC SYSTEMS:

- ALWAYS WEAR safety glasses and impenetrable gloves.
- USE paper or cardboard to search for leaks.
- DO NOT USE hands or body parts to search for leak.
- KEEP hands and body AWAY from pin holes and nozzles ejecting hydraulic fluid.
- Hydraulic fluid may cause gangrene if not surgically removed immediately by a doctor familiar with this form of injury.

Use caution when removing Hydraulic Tank cap.

- Tank contents may be under pressure.
- Allow oil to cool before removing cap.
- Relieve oil pressure before removing cap slowly.
- Stay away from hot oil that may spray from tank.

PN HPBM-01str

SAFETY

ELECTRICAL & FIRE HAZARDS

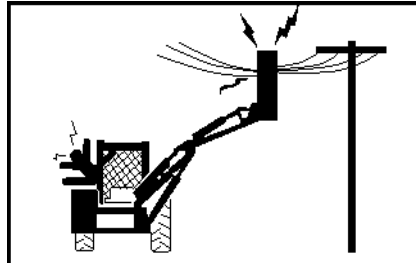

Mower head or Boom contacting overhead electrical lines

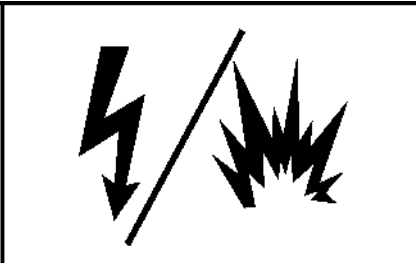

Strike and explosion Hazard
Blades Contacting Utility or Gas Lines

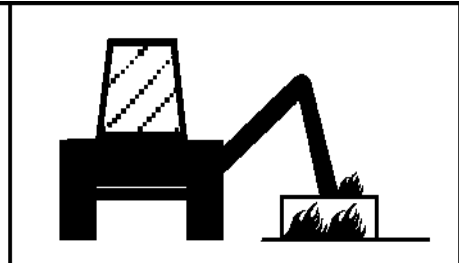

Fire Hazard Do Not operate near fires. Keep debris away from hydraulic pumps and valves



TO AVOID DEATH OR SERIOUS INJURY FROM ELECTRICAL CONTACT WHEN WORKING AROUND ELECTRICAL POWER LINES, GAS LINES AND UTILITY LINES:

- INSPECT mowing area for overhead or underground electrical power lines, obstructions, gas lines, cables and Utility, Municipal, or other type structure.
- KEEP all raised wings at a 10 feet or greater distance from all power lines and overhead obstructions.
- DO NOT allow mower to contact with any Utility, Municipal, or type of structures and obstructions.
- CALL 811 and 1-800-258-0808 for identify buried utility lines.

FIRE PREVENTION GUIDELINES while Operating, Servicing, and Repairing Mower and Tractor to reduce equipment and grass fire Risk:

- EQUIP Tractor with a FIRE EXTINGUISHER.
- DO NOT OPERATE mower on a tractor equipped with under frame exhaust.
- DO NOT SMOKE or have open flame near Mower or Tractor.
- DO NOT DRIVE into burning debris or freshly burnt area.
- AVOID FIRE IGNITION by not allowing mower blade to contact solid objects like metal or rock.
- DO NOT operate if oil is leaking. Repair oil leak and remove all accumulated oil before operating.
- CLEAR any grass clippings or debris buildup around mower hydraulic pumps, valves or tanks.
- SHUT OFF ENGINE while refueling. *PN EFBM-01str*

SAFETY

TRANSPORTING HAZARDS

		
<p>Use SMV signs and Flashing Lights</p>	<p>Loss of Control Stopping Hazard</p>	<p>Loss of Control Speeding Hazard</p>

⚠️ WARNING TO AVOID DEATH OR SERIOUS INJURY WHEN TOWING OR TRANSPORTING EQUIPMENT:

- KEEP transport speed BELOW 20 mph to maintain control of equipment.
- REDUCE SPEED on inclines, turns and in poor towing conditions.
- DO NOT TOW with trucks or other vehicles.
- USE only properly sized and equipped tractor for towing equipment.
- FOLLOW all local traffic regulations.

TRACTOR REQUIREMENTS FOR TOWING OR TRANSPORTING IMPLEMENTS:

- ONLY TRANSPORT with tractor with ROPS in the raised position.
- USE properly sized and equipped tractor that exceeds implement weight by at least 20%.
- KEEP 20% of tractor weight on front wheels to maintain safe steering.

BEFORE TRANSPORTING OR TOWING IMPLEMENT:

TRACTOR INSPECTION:

- CHECK steering and braking for proper operation and in good condition.
- CHECK SMV sign, reflectors and warning lights for proper operation and visibility behind unit.
- CHECK that your driving vision is not impaired by tractor, cab, or implement while seated in tractor seat.
- ADJUST your operating position, mirrors, and implement transport for clear vision for traveling and traffic conditions.

PREPARE IMPLEMENT FOR TRANSPORTING OR TOWING:

- Store Boom and Mower in transport positions and engage transport locks if equipped.

DETERMINE STOPPING CHARACTERISTICS OF TRACTOR AND IMPLEMENT FOR TRANSPORTING OR TOWING:

BRAKE TESTS:

- Stopping distance with implement attached may increase.
- Observe STOPPING distances increases with increased speeds.
- DETERMINE the maximum safe transport speed that does not exceed 20 mph.
- Reduce travel speed on wet or icy roads, stopping distances increase.

DETERMINE MAXIMUM TURNING SPEED BEFORE OPERATING ON ROADS OR UNEVEN GROUND:

- TEST equipment by slowly increasing speed in turns to determine if it can be operated at higher speeds.
- USE REDUCED turning speeds on sharp turns to avoid equipment turning over.

WHEN TOWING OR TRANSPORTING EQUIPMENT:





- Always WEAR SEAT BELT when operating or transporting mower.
- USE low speeds to avoid overturning with raised wings.
- USE low speeds and gradual steering on curves, hills, rough or uneven surfaces, and on wet roads.
- TURN ON tractor FLASHING WARNING LIGHTS.
- ALLOW clearance for implement swing while turning.

KEEP raised boom mower 10 feet or greater distance from all power lines and overhead obstructions.

PN THBM-01 str

SAFETY

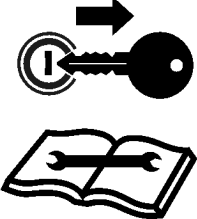
HAZARDS WITH MAINTENANCE OF IMPLEMENT

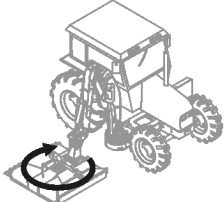
				
<p>Periodically inspect all moving parts, lubricate drivelines, and tighten all fasteners</p>	<p>Lower mower head to ground or block up before servicing</p>	<p>Stop engine remove key before conducting maintenance</p>	<p>Set mower head securely on the ground before servicing blades</p>	<p>Thrown Objects Hazard Ensure blades rotate clockwise viewed from above mower head</p>







AVOID DEATH OR SERIOUS INJURY FROM COMPONENT FAILURE BY KEEPING IMPLEMENT IN GOOD OPERATING CONDITION BY PERFORMING PROPER SERVICE, REPAIRS AND MAINTENANCE.

BEFORE PERFORMING SERVICE, REPAIRS AND MAINTENANCE ON THE IMPLEMENT:

- STOP ENGINE AND PTO, engage parking brake, lower implement, allow all moving parts to stop and remove key before dismounting from tractor.
- PLACE implement on ground or securely block up raised equipment. Use large blocks on soft or wet soil.
- PUSH and PULL Remote Hydraulic Cylinder lever to relieve hydraulic pressure.
- DISCONNECT Pump solenoid valve or PTO driveline connection before servicing mower head.
- WEAR SAFETY GLASSES (with side shields marked to comply with ANSI Z87), PROTECTIVE GLOVES and follow SAFETY PROCEDURES when performing service, repairs and maintenance on the implement:
- Always WEAR protective GLOVES when handling blades, knives, cutting edges or worn component with sharp edges.
- Always WEAR GLOVES and SAFETY GLASSES when servicing hot components.
- AVOID CONTACT with hot hydraulic oil tanks, pumps, motors, valves and hose connection surfaces.
- SECURELY support or BLOCK UP raised implement, framework and lifted components before working underneath equipment.
- FOLLOW INSTRUCTIONS in maintenance section when replacing hydraulic cylinders to prevent component falling.
- STOP any implement movements and SHUT-OFF engine before doing any work procedures.
- USE ladder or raised stands to reach high equipment areas inaccessible from ground.
- ENSURE good footing by standing on solid flat surfaces when getting on implement to perform work.
- FOLLOW manufacturer's instructions in handling oils, solvents, cleansers, and other chemical agents.
- DO NOT change any factory-set hydraulic calibrations to avoid component or equipment failures.
- DO NOT modify or alter implement, functions or components.
- DO NOT WELD or repair rotating mower components. These may cause vibrations and component failures being thrown from mower. *PN HMBM-01*

SAFETY

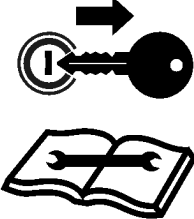
HAZARDS WITH MAINTENANCE OF IMPLEMENT - CONTINUED

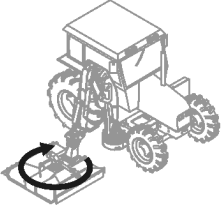
				
Periodically inspect all moving parts, lubricate drivelines, and tighten all fasteners	Lower mower head to ground or block up before servicing	Stop engine remove key before conducting maintenance	Set mower head securely on the ground before servicing blades	Thrown Objects Hazard Ensure blades rotate clockwise viewed from above mower head

PERFORM SERVICE, REPAIRS, LUBRICATION AND MAINTENANCE OUTLINED IN IMPLEMENT MAINTENANCE SECTION:

- INSPECT for loose fasteners, worn or broken parts, leaky or loose fittings, missing or broken cotter keys and washers on pins, and all moving parts for wear.
- REPLACE any worn or broken parts with authorized service parts.
- Inspect mower blade spindle to ensure bearing pre-load. If loose repair before operating.
- LUBRICATE unit as specified by lubrication schedule.
- NEVER lubricate, adjust or remove material while it is running or in motion.
- TORQUE all bolts and nuts as specified.

BLADE INSPECTION:

- Inspect blade carrier and blades daily.
- Check blade and blade carrier BOLT TORQUE daily. Loose bolts can cause blade or blade bolt failures.
- REPLACE, bent, damage, cracked and broken blades immediately with new blades.
- AVOID blade failures and thrown broken blades. DO NOT straighten, weld, or weld hard-facing blades.

SAFETY SHIELDS, GUARDS AND SAFETY DEVICES INSPECTION:

- KEEP all Deflectors, Chain Guards, Steel Guards, Gearbox Shields, and PTO integral shields, Bands, Side Skirts and Skid Shoes in place and in good condition.
- REPLACE any missing, broken or worn safety shields, guards and safety devices.

⚠ WARNING Cancer and Reproductive Harm www.P65Warnings.ca.gov. PN HMBM-01 (2) str

SAFETY

SAFETY

PARTS INFORMATION

Bush Hog mowers use balanced and matched system components for blade carriers, blades, cuttershafts, knives, knife hangers, rollers, drivetrain components, and bearings. These parts are made and tested to Bush Hog specifications. Non-genuine "will fit" parts do not consistently meet these specifications. The use of "will fit" parts may reduce mower performance, void warranties, and present a safety hazard. Use genuine Bush Hog mower parts for economy and safety. (SPBH-1) str

SEE YOUR BUSH HOG DEALER

Operator's & Parts Manuals



www.algqr.com/bpm

SAFETY

SAFETY

SAFETY

ITEM	PART NO.	QTY	TYPE	DESCRIPTION
1.	D823	1	DANGER	Multi-Hazard
2.	D625	1	WARNING	Pressurized Tank
3.	D825	1	DANGER	Multi-Language General Safety
4.	D723	1	INSTRUCT	Lube Chart
5.	D628	1	DANGER	Crushing and Pinch Point Hazards
6.	D623	6	WARNING	Pinch Point Hazard
7.	D547	1	DANGER	Driveline Hazard, Operate at 540 RPM
8.	D617	1	WARNING	Hydraulic Oil Leak
9.	D716	1	WARNING	Stabilizer and Sway Bar Positioned
10.	D719	1	DANGER	Automatic Breakaway Return
11.	D618	1	WARNING	Multiple Hazard
12.	50063360	1	LOGO	Bush Hog (8" x 1.76")
13.	50068741	2	LOGO NAME	RMB 1445
14.	50061049	1	LOGO	Bush Hog (22")
15.	83380	1	REFLECT	SMV Sign
16.	NFS	1	SERIAL PLT	Serial Number Plate
17.	7103230	4	---	1/8" Pop Rivet
18.	46503.01	1	---	Seal
19.	50068815	1	---	Operator's Manual
20.	50035829	1	---	Canister, Operator's Manual
21.	9313043	3	---	Setscrew
22.	9100103	3	---	Flatwasher
23.	9143003	3	---	Self -Locking Nut
24.	D559	1	WARNING	Use Genuine Bush Hog Parts

SAFETY

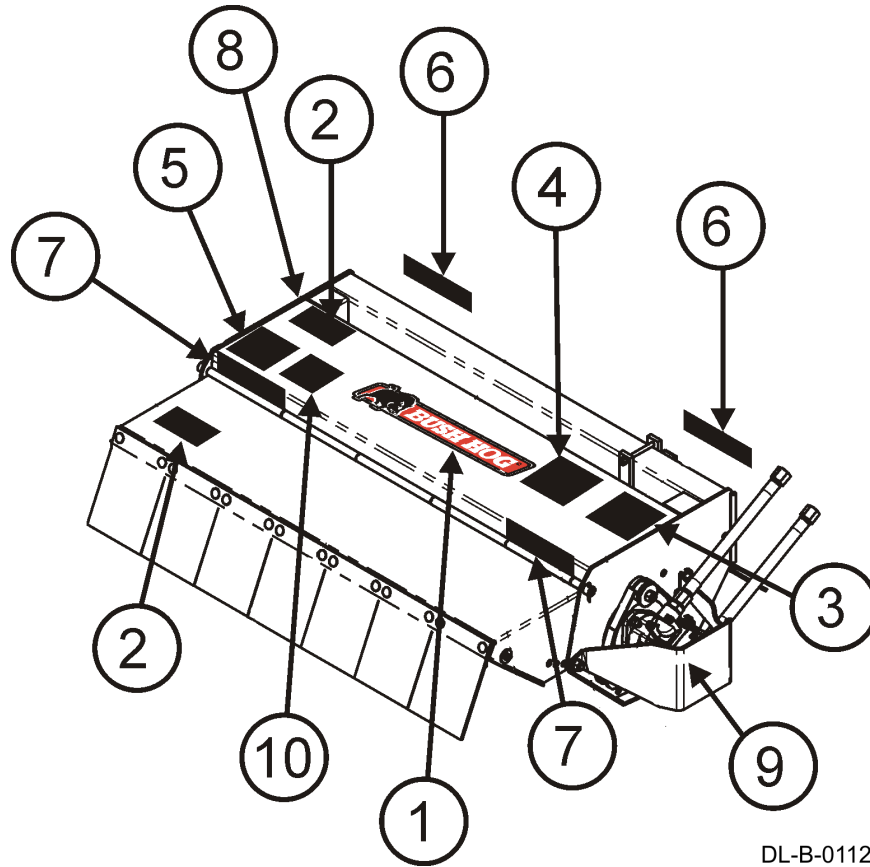

DL-B-0112

ITEM	PART NO.	QTY	TYPE	DESCRIPTION
1.	50061049	1	LOGO	Bush Hog (22")
2.	D626	1	DANGER	Thrown Objects
3.	D717	1	DANGER	Multi-Thrown Objects
4.	D559	1	WARNING	Use Genuine Bush Hog Parts
5.	D720	1	WARNING	Blade Attachment Failure
6.	1458392	2	REFLECT	Red Reflector
7.	1458393	2	REFLECT	Yellow Reflector
8.	NFS	1	SERIAL PLT	Serial Number Plate
9.	09.810.01	2	INSTRUCT	Grease Every 8 Hours
10.	D724	1	INSTRUCT	Lube Chart
11.	7103230	4	---	1/8" Pop Rivet (not shown)

SAFETY

SAFETY

SAFETY

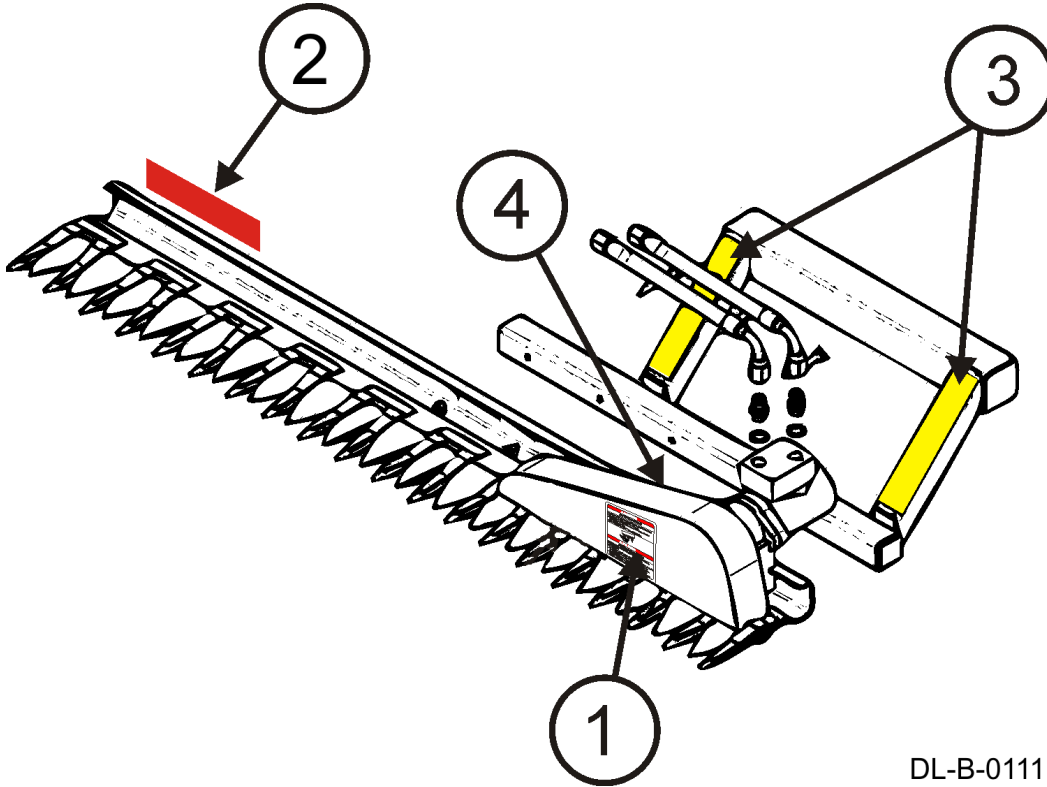









DL-B-0111

ITEM	PART NO.	QTY	TYPE	DESCRIPTION
1.	D731	1	DANGER	Sharp Blades
2.	1458392	1	REFLECT	Red Reflector
3.	1458393	2	REFLECT	Yellow Reflector
4.	NFS	1	SERIAL PLT	Serial Number Plate

SAFETY

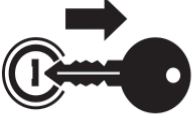

SAFETY



DECAL DESCRIPTION

⚠ DANGER			
			 D823_1
THROWN OBJECTS HAZARD			
<p>Mower can throw objects up to 300 feet. TO AVOID DEATH OR SERIOUS INJURY to operator or bystanders:</p> <ul style="list-style-type: none">● STOP mowing if pedestrians or bystanders come within 300 feet.● DO NOT OPERATE with thrown object shielding removed.● KEEP thrown object shielding in place and in good condition during operation. Thrown Objects shielding is subject to wear.● REPAIR OR REPLACE shielding if damaged, broken or missing. See Operator's Manual for all Shields and Guards.● INSPECT area for potential mower thrown object hazards before mowing.● Remove and AVOID objects such as wire, cable, metal objects and all other foreign material.● DO NOT ALLOW blades to contact solid objects like wire, rocks, posts, curbs or guard rails.● DO NOT operate without operator protective shielding or cab.			
⚠ DANGER			
			
Run Over Hazard - Death or Injury			
<p>TO AVOID DEATH OR SERIOUS INJURY:</p> <ul style="list-style-type: none">● ALWAYS BUCKLE UP seat belt.● ONLY START Tractor while seated in the operator's seat.● STOP ENGINE and PTO, engage parking brake, lower implement, allow all moving parts to stop and remove key before dismounting from tractor.● KNOW HOW to stop tractor and equipment quickly for an emergency.● DO NOT MOUNT or DISMOUNT Tractor in motion.● NEVER ALLOW riders on tractor or implement.● NEVER ALLOW children to operate or ride on tractor or implement.● KEEP BYSTANDERS CLEAR of area before moving tractor or implement.● KEEP ALERT and AVOID hitting stumps, holes, ruts, and uneven terrain.● AVOID tree limbs, brush and other overhanging objects that can strike and throw the operator from seat. <p>D823_4</p>			

SAFETY

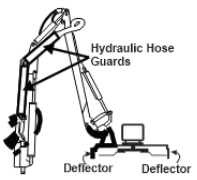
SAFETY

! DANGER	
ENTANGLEMENT HAZARD	
<p>TO AVOID DEATH OR SERIOUS INJURY:</p> <ul style="list-style-type: none"> • DO NOT operate without guards in place and in good condition. PTO and gearbox guarding are SUBJECT TO WEAR. • STAY AWAY and KEEP hands, feet and body AWAY from rotating blades, drivelines and parts that continue to move after power shut-off. WAIT until all moving elements have stopped. • ALWAYS REPLACE GUARDS that have been removed for service or maintenance. • STOP, LOOK and LISTEN for rotating motion before approaching implement. 	  <p style="font-size: small;">Hydraulic Hose Guards Deflector Deflector</p>
D823_2	

! DANGER	
Crushing Hazard - Death or Injury	
<p>TO AVOID DEATH OR SERIOUS INJURY:</p> <ul style="list-style-type: none"> • USE tractor equipped with Rollover Protective Structure ("ROPS") including roll bar and seat belt. Keep roll bar in raised position. • CLEAR AREA of bystanders before raising or lowering mower. • IMPLEMENT CAN FALL from hydraulic failure or accidental operation of controls. • BLOCK UP and securely support equipment before putting hands, feet or body under raised equipment or lifted components. 	 
D823_3	

! DANGER			
			
D823_5	www.algqr.com/bbe		
<p>TO AVOID DEATH OR SERIOUS INJURY:</p> <ul style="list-style-type: none"> • READ AND UNDERSTAND the provided Operator's Manuals, safety signs and information decals for tractor and implement before operating equipment. • CONTACT DEALER immediately if you do not have manuals. • CONTACT DEALER to explain any instructions not fully understood. • ALWAYS WEAR safety glasses with side shields (marked with ANSI Z87). • WEAR hard hat, safety shoes and gloves for protection when operating equipment. 			D823

SAFETY

⚠ WARNING



**PRESSURIZED TANK
OIL FILLER CAP IS
PRESSURE RELIEF CAP**

**TO AVOID DEATH AND SERIOUS
INJURY FROM HOT OIL:**

- STAY AWAY from hot oil that may spray out of tank.
- ALLOW oil to cool down BEFORE removing cap .
- SLOWLY remove cap to relieve pressure BEFORE removing completely.

D625

⚠ DANGER

CRUSHING HAZARD AND PINCH POINTS



TO AVOID DEATH OR SERIOUS INJURY:

- KEEP AWAY from moving machinery parts that can pinch, crush or fall.

D628

⚠ WARNING

**AVOID PINCH POINTS THAT CAN
RESULT IN SERIOUS INJURY**

D623



SAFETY

SAFETY

 PELIGRO	 DANGER
Si no puede leer inglés: antes de poner en funcionamiento este equipo, solicite que alguien le traduzca los mensajes de seguridad o vaya al sitio web para consultar los mensajes de seguridad y las etiquetas ya traducidos.	Si vous ne pouvez pas lire l'anglais : avant d'utiliser l'équipement, demandez à une personne de vous traduire les messages de sécurité ou allez sur le site Internet pour voir la traduction des autocollants et des messages de sécurité.
El Manual del Operador Seguridad vídeo   www.algqr.com/bbs	Manuel de l'Opérateur   www.algqr.com/bbf
 www.algqr.com/avs	

 PERIGO	 GEFAHR
Caso você não leia inglês: antes de operar o equipamento, peça para alguém traduzir as mensagens de segurança ou visite a web e obtenha tais mensagens ou os decalques traduzidos.	Falls Sie nicht Englisch sprechen: Bevor Sie die Geräte in Betrieb nehmen, bitten Sie eine Englisch sprechende Person darum, Ihnen die Sicherheitsmeldung zu übersetzen, oder besuchen Sie die Website; dort finden Sie übersetzte Aufkleber und Sicherheitsmeldungen.
Manual do Operador   www.algqr.com/bbp	Benutzerhandbuch   www.algqr.com/bbg
	D825

SAFETY

SAFETY

DANGER



TO AVOID DEATH OR SERIOUS INJURY FROM DRIVELINE CONTACT, DRIVELINE SEPARATION OR PTO STUB SHAFT FAILURE:

- STOP, LOOK and LISTEN for rotating motion before approaching implement.
- STAY AWAY and KEEP hands, feet and body AWAY from driveline & rotating parts until all moving elements have stopped.
- ALWAYS shut off PTO before dismounting.
- DO NOT operate if PTO shields are damaged or missing.
- PUSH AND PULL on yoke until collar clicks and locks yoke in place.
- CHECK driveline guards for free rotation and sufficient overlap to avoid unshielded areas.
- DO NOT USE PTO ADAPTER.

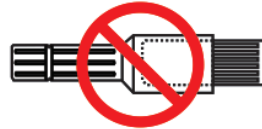
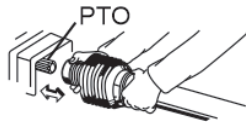

WARNING

OPERATE THIS MACHINE AT

540 RPM

TRACTOR PTO SPEED ONLY.

Overspeeding PTO may cause component failure resulting in bodily injury.

TRACTOR PTO ROTATION: CLOCKWISE



D547

SAFETY

⚠ WARNING



TO AVOID DEATH OR SERIOUS INJURY FROM HIGH PRESSURE HYDRAULIC OIL LEAKS PENETRATING SKIN:

- DO NOT OPERATE equipment with oil or fuel leaks.
- KEEP all hydraulic hoses, lines and connections in good condition and tight before applying system pressure.
- Relieve hydraulic pressure before disconnecting lines or working on the system.
- REMOVE and replace hose if you suspect it leaks. Have dealer test it for leaks.

HIGH PRESSURE FLUID LEAKS CAN BE INVISIBLE. WHEN CHECKING FOR HYDRAULIC LEAKS AND WORKING AROUND HYDRAULIC SYSTEMS:

- DO NOT use hands to check for leaks.
- ALWAYS WEAR safety glasses with side shields (marked to comply with ANSI Z87) and impenetrable gloves.
- USE paper or cardboard to search for leaks.
- KEEP hands and body AWAY from pin holes and nozzles ejecting hydraulic fluid.
- Hydraulic fluid may cause gangrene if not surgically removed immediately by a doctor familiar with this form of injury.

D617

⚠ WARNING

TO AVOID INJURY OR EQUIPMENT DAMAGE:

- Make certain stabilizers and sway blocks are positioned to stabilize boom and prevent sideways motion.

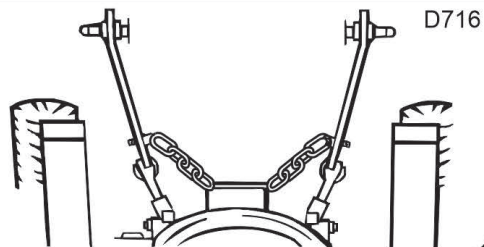
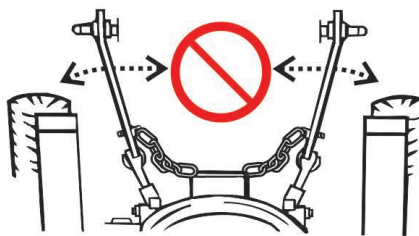

D716

SAFETY

SAFETY

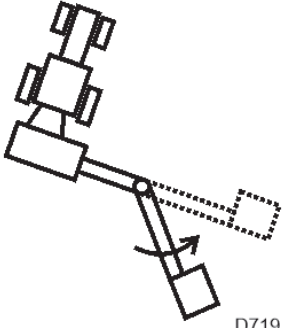
⚠ DANGER	
<p>KEEP AWAY</p> <p>AUTOMATIC BREAKAWAY</p> <p>RETURN</p> <p>Keep clear of the front of the arm and head.</p>	
D719	

⚠ WARNING	⚠ WARNING
	
<p>TO AVOID DEATH OR SERIOUS INJURY DURING TRANSPORTATION:</p> <ul style="list-style-type: none"> • ALWAYS BUCKLE UP seat belt. • PLACE boom securely in Transport Rest and turn off master switch. • CHECK SMV sign, reflectors and warning lights for visibility behind unit. • TURN ON tractor flashing warning lights. <p>TO AVOID LOSS OF TRANSPORTATION CONTROL:</p> <ul style="list-style-type: none"> • DO NOT travel at speeds over 20 mph. • REDUCE SPEED on inclines, in turn and in poor weather conditions. <p style="text-align: right;">D618_1</p>	<p>TO AVOID DEATH OR SERIOUS INJURY DURING OPERATION:</p> <ul style="list-style-type: none"> • DO NOT lift implement while on steep slopes. • KEEP AWAY from soft ditch banks and holes. • ALWAYS MAINTAIN 1500 pounds of contact between wheels and surface. Widen wheel tread or add weight if needed. (see Operator's Manual) • ALWAYS MAINTAIN 20% of tractor weight on front wheels. • DO NOT start or accelerate suddenly. • KEEP mower AT LEAST 10 FEET AWAY from electric lines and pipe lines. <p style="text-align: right;">D618_2</p>
⚠ WARNING	
<p>TO AVOID EQUIPMENT AND GRASS FIRES:</p> <ul style="list-style-type: none"> • CLEAR AWAY grass or debris from hydraulic lines, circuits and decks. <p>TO AVOID FIRE IGNITION:</p> <ul style="list-style-type: none"> • DO NOT ALLOW BLADES TO CONTACT rocks, metal or solid objects. • DO NOT ALLOW OIL TO SPRAY on hot equipment or components. <p style="text-align: right;">D618</p>	D618_3

SAFETY

SAFETY

! DANGER	
THROWN OBJECT HAZARD	D626
<p>TO AVOID DEATH OR SERIOUS INJURY: DO NOT OPERATE if Thrown Object Shielding is damaged or missing.</p> <ul style="list-style-type: none"> • Maintain Rubber Deflectors in good condition. • Inspect Rubber Deflectors frequently. <p>MAINTAIN Thrown Object Shielding</p> <p style="text-align: center;">↙ HERE ↘</p>	
	 <p style="text-align: center;">Rubber Deflector</p>

! DANGER				
				
				
THROWN OBJECTS HAZARD				
<p>Mower can throw objects up to 300 feet. TO AVOID DEATH OR SERIOUS INJURY to operator or bystanders:</p> <ul style="list-style-type: none"> • CLOSE MOWER DOOR and STOP operating if bystanders or traffic come within 300 feet. • KEEP door fully closed when cutting grass and weeds. • OPEN door ONLY to cut large brush. Keep door closed for all other mowing conditions. • Deflectors are SUBJECT TO WEAR. Replace if worn or damaged. • DO NOT OPERATE with door removed. • ALWAYS transport with door closed. <p>IF MOWER DOOR IS OPEN:</p> <ul style="list-style-type: none"> • DO NOT OPERATE if blades are rotating in reverse rotation (opposite to the tractor tires during forward travel). <p style="text-align: right;">D717</p>				

SAFETY

SAFETY

WARNING

TO AVOID DEATH OR SERIOUS INJURY:

- **ONLY** use genuine Bush Hog replacement parts, which have been validated and tested to use on Bush Hog equipment by the manufacturer.
- The equipment manufacturer cannot verify the material or structural integrity of third-party supplied non-genuine replacement parts.
- Using non-genuine parts can result in the part failing, creating hazardous conditions for operator and bystanders.

Contact local dealer or Bush Hog about repair parts at:
2501 Griffin Ave., Selma, AL 36701
Customer Service: 800-363-6096.
Email: contactus@bushhog.com www.algqr.com/bpm



 **WARNING**
Cancer and Reproductive Harm
www.P65Warnings.ca.gov

IMPORTANT

BE AWARE BE ALERT BE ALIVE	BE TRAINED Before Operating this Mower
---	---



To prevent serious injury to yourself and/or bystanders, be trained in Safe Mowing Practices. Alamo Group Companies as well as AEM and FEMA provide training material that is critical for your Safety and the Safety of others when operating this equipment. Make these Safety Procedures an important part of every workday. Read and understand the Operator's Manual. www.algqr.com/bve

Do not let untrained individuals operate this equipment. Contact your Dealer, AEM (www.aem.org), FEMA (314-878-2304, www.FarmEquip.org), or Alamo Group (www.Alamo-Group.com) for information on training material or courses that provide training in Safer Operating Practices for Mowers.

D559

SAFETY

SAFETY

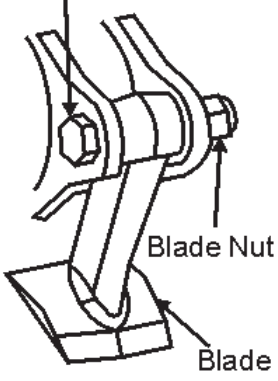
⚠ WARNING	
<p>TO AVOID DEATH OR SERIOUS INJURY FROM BLADE ATTACHMENT FAILURE:</p> <ul style="list-style-type: none">• Check blade bolts DAILY for tightness.• Torque blade bolt to 150 ft lbs.• ALWAYS replace blades with new bolts and nuts.	<p>Blade Bolt</p>  <p>Blade Nut</p> <p>Blade</p> <p>D720</p>

⚠ DANGER	
 <p>D731</p>	<p>AMPUTATION HAZARD</p> <p>TO AVOID SERIOUS INJURY FROM BLADE CONTACT:</p> <ul style="list-style-type: none">• Keep away until all motion has stopped.• Keep fingers clear of cutterbar when folding cutterbar into transport position.• KEEP all persons AWAY from sickle blades.

SAFETY

FEDERAL LAWS AND REGULATIONS

This section is intended to explain in broad terms the concept and effect of federal laws and regulations concerning employer and employee equipment operators. This section is not intended as a legal interpretation of the law and should not be considered as such.

Employer-Employee Operator Regulations

U.S. Public Law 91-596 (The Williams-Steiger Occupational and Health Act of 1970) OSHA

This Act Seeks:

“...to assure so far as possible every working man and woman in the nation safe and healthful working conditions and to preserve our human resources...”

DUTIES

Sec. 5 (a) Each employer-

- (1) shall furnish to each of his employees employment and a place of employment which are free from recognized hazards that are causing or are likely to cause death or serious physical harm to his employees;
- (2) shall comply with occupational safety and health standards promulgated under this Act.
- (b) Each employee shall comply with occupational safety and health standards and all rules, regulations and orders issued pursuant to this Act which are applicable to his own actions and conduct.

OSHA Training Requirements

Title 29, Code of Federal Regulations Part 1928.57(a)(6). www.osha.gov

Operator instructions. At the time of initial assignment and at least annually thereafter, the employer shall instruct every employee who operates an agricultural tractor and implements in the safe operating practices and servicing of equipment with which they are or will be involved, and of any other practices dictated by the work environment.

Keep all guards in place when the machine is in operation.

Permit no riders on equipment.

Stop engine, disconnect the power source, and wait for all machine movement to stop before servicing, adjusting, cleaning, or unclogging the equipment, except where the machine must be running to be properly serviced or maintained, in which case the employer shall instruct employees as to all steps and procedures which are necessary to safely service or maintain the equipment.

Make sure everyone is clear of machinery before starting the engine, engaging power, or operating the machine.

Employer Responsibilities:

To ensure employee safety during Tractor and Implement operation, it is the employer's responsibility to:

1. Train the employee in the proper and safe operation of the Tractor and Implement.
2. Require that the employee read and fully understand the Tractor and Implement Operator's Manual.
3. Permit only qualified and properly trained employees to operate the Tractor and Implement.
4. Maintain the Tractor and Implement in a safe operational condition and maintain all shields and guards on the equipment.
5. Ensure the Tractor is equipped with a functional ROPS and seat belt and require that the employee operator securely fasten the safety belt and operate with the ROPS in the raised position at all times.
6. Forbid the employee operator to carry additional riders on the Tractor or Implement.
7. Provide the required tools to maintain the Tractor and Implement in a good safe working condition and provide the necessary support devices to secure the equipment safely while performing repairs and service.
8. Require that the employee operator stop operation if bystanders or passersby come within 300 feet.

Child Labor Under 16 Years of Age

Some regulations specify that no one under the age of 16 may operate power machinery. It is your responsibility to know what these regulations are in your own area or situation. (Refer to U.S. Dept. of Labor, Employment Standard Administration, Wage & Home Division, Child Labor Bulletin #102.)

INDUSTRIAL/AGRICULTURAL MOWER

AEM 

Association of
Equipment Manufacturers



SAFETY MANUAL

FOR OPERATING AND MAINTENANCE PERSONNEL

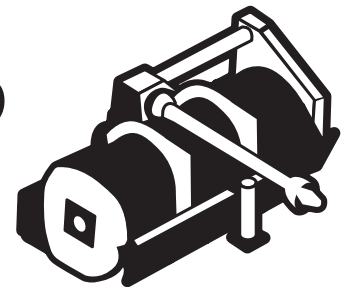
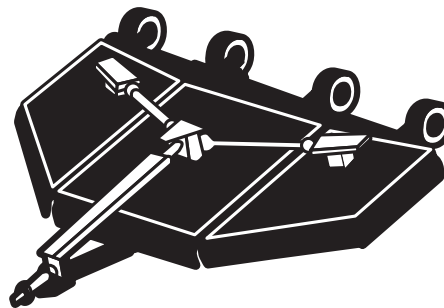
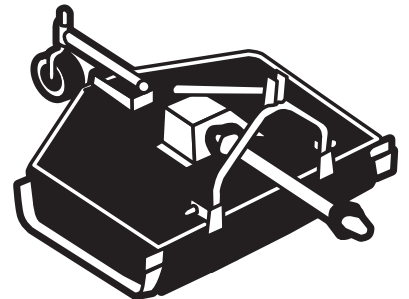
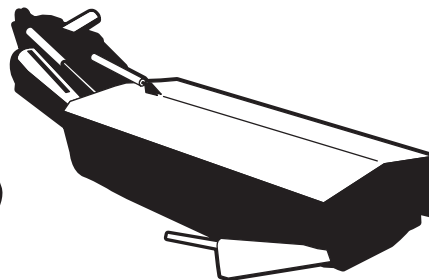
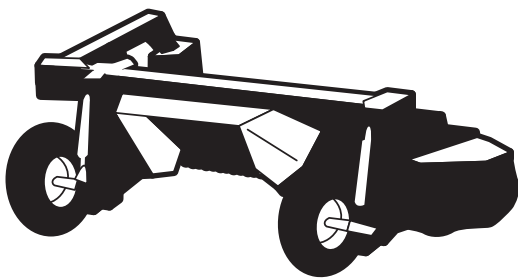

ISBN 978-1-937029-54-8

90000 >



9 781937 029548



Table of Contents

Acknowledgment.....	2
Foreword	3
Safety Alerts.....	4
A Word to the User/Operator	5
Types of Industrial/Agricultural Mowers	6
Follow a Safety Program.....	8
Prepare for Safe Operation.....	13
Start Safely.....	22
Operate Safely	24
Shut Down Safely	38
Perform Maintenance Safely.....	39
Final Word to the User	55

Acknowledgment

We wish to thank the members of the Association of Equipment Manufacturers for their invaluable contributions in preparing this Safety Manual.

NOTICE OF COPYRIGHT PROTECTION

Copyright, 2023, by the Association of Equipment Manufacturers. All rights reserved. This work may not be reproduced or disseminated in whole or in part by any means without the prior written permission of the Association of Equipment Manufacturers.

ISBN 978-1-937029-54-8

Copyright © 2003-2023 AEM (Association of Equipment Manufacturers) Revised 01/03, 09/10 and 01/24

Foreword

This safety manual is intended to point out some of the basic safety situations that may be encountered during the normal operation and maintenance of your machine and to instruct you in safety practices for dealing with these conditions. This manual is **NOT** a substitute for the manufacturer's operator's manual(s).

Additional precautions may be necessary, or some instructions may not apply, depending on equipment, attachments and conditions at the job site or in the service area. The manufacturer has no direct control over equipment application, operation, inspection, or maintenance. Therefore, it is **YOUR** responsibility to use good safety practices in these areas.

The information provided in this manual supplements the specific information about your machine that is contained in the manufacturer's operator's manual(s). Other information that may affect the safe operation of your machine may be contained in the following:

- Safety signs
- Insurance requirements
- Employer safety and training programs
- Safety codes
- Local, state/provincial, and federal laws, rules, and regulations

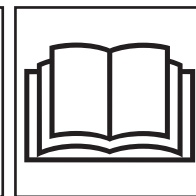

Read and understand
manuals before
operating

IMPORTANT! Before you operate this machine, make sure you have the manufacturer's operator's manual(s) for this machine and all attachments. If the manufacturer's operator's manuals are missing, obtain replacements from your employer, equipment dealer, or directly from the manufacturer. Keep this safety manual and the manufacturer's operator's manuals with the machine at all times. Read and understand all applicable manuals.

Safety videos and other training resources are available from some manufacturers and dealers. The AEM Industrial/Agricultural Mower Safety video is available to train and reinforce good safety practices. This video is available at www.safetymaterials.org. Operators are encouraged to periodically review these resources.

Safety Alerts

Safety Alert Symbol

This Safety Alert Symbol means: **“Attention! Stay alert! Your safety is involved!”**



The Safety Alert Symbol is used to alert you to potential hazards and identifies important safety messages on equipment, safety signs, in manuals, or elsewhere. When you see this symbol, be alert to the possibility of death or personal injury. Carefully read the message that follows and inform other operators. Follow instructions in the safety message.

Signal Words

Signal words are distinctive words that are typically found on safety signs on the mower and other job site equipment. These words may also be found in this manual and the manufacturer's operator's manuals. These words are intended to alert the operator to a hazard and the degree of severity of the hazard.



DANGER indicates a hazardous situation that, if not avoided, will result in death or serious injury.



WARNING indicates a hazardous situation that, if not avoided, could result in death or serious injury.



CAUTION indicates a hazardous situation that, if not avoided, may result in minor or moderate injury.



NOTICE is used to address practices not related to physical injury.

A Word to the User/Operator

It is **YOUR** responsibility to read and understand this safety manual and the manufacturer's operator's manual(s) before operating this equipment. This safety manual takes you step by step through the working day.

Graphics have been provided to help you understand the text.

Hazard recognition and accident prevention depend upon you being alert, careful, and properly trained in the inspection, operation, transport, maintenance, and storage of this equipment.

Remember that **YOU** are the key to safety. Good safety practices not only protect you but also protect the people around you. Study this manual and the manufacturer's operator's manual(s) for the specific machine. Make them a working part of your safety program. Keep in mind that this safety manual is written only for industrial/agricultural mowers.

After studying the manufacturer's operator's manual(s) and this safety manual, please contact the equipment manufacturer with any remaining questions.



Read and understand manuals before operating

Practice all customary safe working precautions and remember:

Safe operation is up to you!

You can prevent death or serious injury caused by unsafe work practices!

Types of Industrial/Agricultural Mowers

Industrial/Agricultural Mower Types

Mowers are used for clipping pastures, shredding crop residue, cutting heavy brush, and mowing waterways, right-of-ways, roadsides or highways. Also, these mowers are used for cutting grass and other growth in public areas such as parks and cemeteries.

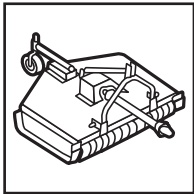

Rotary

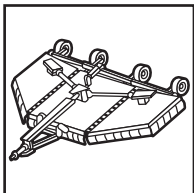

Folding wing rotary

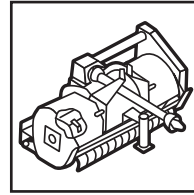

Flail

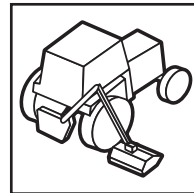

Boom

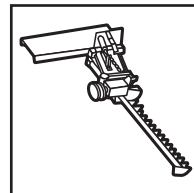

Sickle bar

Types of Industrial/Agricultural Mowers

Agricultural Disc Mower Types

Disc mowers are designed and equipped to cut hay crops at higher field speed.

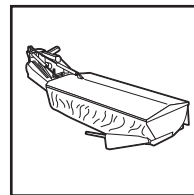

Disc Mower

Disc mower conditioners mow and condition crops.

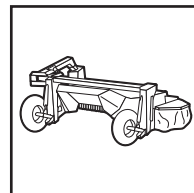

Disc mower conditioner

Self-propelled windrowers mow and form conditioned hay into windrows.

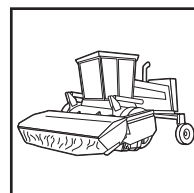

Self-propelled windrower

Follow a Safety Program

For Safe Operation

You must be a qualified and authorized operator to safely operate this machine. You must clearly understand the written instructions supplied by the manufacturer, be trained—including actual operation—and know the safety rules and regulations for the job site. It is a good safety practice to point out and explain safety signs and practices to others, and to make sure they understand the importance of following these instructions.



Never operate while impaired by alcohol or drugs

⚠ WARNING! Death or serious injury could result from operating machinery while impaired by drugs or alcohol. Drugs and alcohol affect operator alertness, coordination, and the ability to safely operate the equipment. **Never operate the machine while impaired by use of alcohol or drugs. Never knowingly allow anyone to operate the machine when their alertness or coordination is impaired.**

An operator taking prescriptions or over-the-counter medication must consult a medical professional regarding any side effects of the medication that would hinder their ability to safely operate this equipment.

Be Alert!

Know where to get assistance. Keep emergency numbers for doctors, ambulance service, hospital, and fire department near your telephone. Know how to use a first aid kit and fire extinguisher/fire suppression system; know their location and practice getting to them. Ensure they have been properly tested and maintained.

Let others know where you will be working, and what time you will be returning. In case of an emergency, you want others to know where to find you.

Be Aware!

Take advantage of training programs offered.

Know the proper response to a fire or chemical spill on your machine.

Follow a Safety Program

Be Careful!

Human error is the result of many factors: carelessness, fatigue, sensory overload, preoccupation, unfamiliarity with the machine or attachments, or drugs and alcohol, to name a few. You can avoid death or serious injury caused by these and other unsafe work practices. Be careful; never assume accidents cannot happen to you.

For your safety and the safety of others, act safely and encourage your fellow workers to act safely as well.

Protect Yourself

Wear the proper personal clothing and all personal protective equipment (PPE) issued to you or called for by job conditions.

You may need:

- Hard hat
- Safety shoes
- Safety glasses, goggles, or face shield
- Heavy duty gloves
- Hearing protection
- Reflective clothing
- Wet weather gear
- Respirator or filter mask

Wear whatever is needed to protect yourself—do not take chances.

⚠ WARNING! Avoid death or serious injury from entanglement. **Do not wear loose or frayed clothing or accessories that could catch on moving parts.**

Examples of items to avoid include flopping cuffs, dangling neckties and scarves, wallets attached to chains, jewelry, wrist bands and wrist watches.

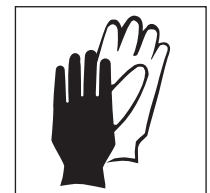
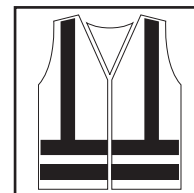
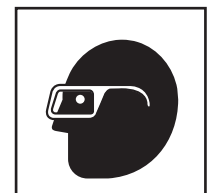

Follow a Safety Program

Know the Rules

Most job sites have rules governing equipment use and maintenance. Before you start work at a new location, check with the supervisor or safety coordinator. Ask about the rules you will be expected to obey.

OSHA enforces federal laws within the United States that apply to the safe operation, application, and maintenance of equipment on some job sites. It is the employer's responsibility to comply with these laws. A federal representative may periodically inspect a job site to see that these laws are being followed.

There may be other local, state/provincial, federal laws or international organizations that regulate the use of this equipment, along with specific job site or employer rules. It is important that you know and comply with all applicable laws and rules, **including those requiring operator training and certification.**

These are some of the rules you must work by:

- A Roll-over Protective Structure (ROPS) and seat belt-equipped tractor is a federal government (OSHA) requirement for operator protection during mowing operations. An enclosed cab provides additional operator protection from thrown objects. Check your mower operator's manual(s) to see if a tractor cab is also required.

- Only qualified and authorized individuals may operate this equipment.
- Inspect your machine and attachments before each use as specified by the manufacturer and your employer. Ensure an attachment is properly installed.
- Know the limitations and operating characteristics of your equipment. Do not overload or misuse it.
- Never modify or remove any part of the machine (except for qualified service personnel; then make sure the part is re-installed or replaced if defective or worn out).



Know and understand rules of operation



Fasten your seat belt

Follow a Safety Program

- Wear proper clothing and personal protective equipment (PPE).
- Never allow children to play near, ride on or operate the equipment. Children are not qualified to operate this equipment.
- Do not allow riders.
- Keep bystanders 300 ft (92 m) from the mowing operation for rotary mowers and 100 ft (31 m) for disc mowers.

- Know the work area before you use the equipment. Be aware of possible terrain hazards that you may encounter. Remove or mark obstacles and debris that could damage or be thrown by the mower.
- Properly install all shields and guards before operating the machine.
- Only use attachments and parts that are approved by the manufacturer.
- Whenever you leave you machine, lower the machine and/or all attachments, set the parking brake, shut off the engine and cycle the hydraulic control levers and remove the key before leaving the operator's station. (See page 38, **Safe Shutdown.**)
- Use three-point contact (handholds and steps) and face the equipment when mounting or dismounting. (See page 21, **Mount and Dismount Properly.**)

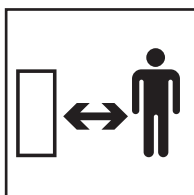

Keep bystanders away



Watch out for thrown objects

Follow a Safety Program

Know the Equipment

Read and understand the DANGER, WARNING, CAUTION, and NOTICE safety labels and other informational signs on the machine, the attachments, and in the manufacturer's operator's manuals. Ask your supervisor or dealer to explain any information you do not understand. Failure to obey safety instructions could result in death or serious injury.

Know the following about your equipment:

- Function, purpose, and use of all controls
- Correct operating speeds
- Braking and steering characteristics
- Slope and uneven terrain capabilities and proper operation
- Turning radius and clearances
- How to quickly stop equipment in an emergency

Keep in mind that rain, snow, ice, loose gravel, soft ground, slopes, and other site conditions can affect your machine's operating capabilities. Make sure you are thoroughly familiar with your machine's stability, braking, traction, and other handling characteristics under any conditions you are likely to encounter.

IMPORTANT: This manual covers safe practices for industrial/agricultural mower equipment. If your machine is equipped with other devices or special attachments, read the manufacturer's operator's manual(s) and safety manuals pertaining to that equipment before using it.

Make sure all the manufacturer's protective structures, guards, shields, screens and panels are in good repair, in place and securely fastened. Damaged, missing or weakened safety components can create a hazardous situation for you as the operator. Never remove or modify any safety components including thrown object shielding on a mower.

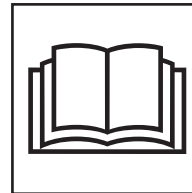

Read and understand manuals before operating

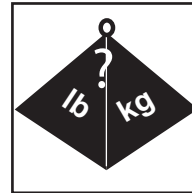

Know machine capacity and operating characteristics

Prepare for Safe Operation

Check and Use All Available Safety Devices

To protect you and others around you, your machine may be equipped with the safety equipment listed below. Additional equipment may be required or some items may not apply, depending on attachments used, job site conditions, or applicable job site rules. Check that each required item is securely in place and in operating condition:

- Seat belt
- Roll-over Protective Structure (ROPS)
- Operating and warning lights
- Safety signs
- Guards
- Mirrors
- First aid kit
- Fire extinguisher/fire suppression system
- Windshield wiper/defroster

Use them! Never remove or disconnect any safety device.

Know which devices are required for protection during your specific operation and use them.

⚠ WARNING! Never remove or modify a ROPS except when servicing the machine. Reinstall it correctly before releasing the machine back into service. Death or serious injury could result.

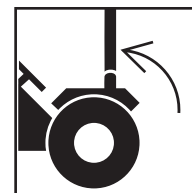

Never modify a ROPS



Fasten your seat belt

Prepare for Safe Operation

Inspect the Machines

Before beginning your workday, check for the following as applicable and repair or replace as needed. Additional details and descriptions are provided throughout this manual. Perform daily and periodic maintenance procedures as instructed by the manufacturer.



Check all safety devices

- Operator station platform is clear of tools, objects, and debris. Associated steps, handholds, or railings are clean and functional.
- Seat belt, anchors, and buckle are in proper working condition.
- Mower PTO driveline yokes, couplers, and shields are in good operating condition.
- Cutting elements and attachment hardware are not worn, damaged or missing. Never try to repair worn or damaged parts; always replace parts with genuine OEM parts.
- Thrown object guarding system is complete and installed.
- Lighting and marking devices such as warning flashers, turn signals, brake lights, work lights, Slow Moving Vehicle (SMV) emblems, Speed Identification Signs (SIS), if applicable, and reflective materials are visible and in operational condition.

Machine Condition

Ensure all components are in operating condition. Check for the following as applicable:

- ROPS is present and, if foldable, is in raised and secured position.
- Cab is in good condition and windows and doors function properly.
- PTO master shield is properly installed and functioning.

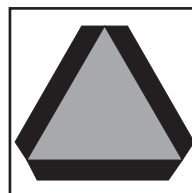

Use lighting and marking

Prepare for Safe Operation

- Keep the operator platform surface clean and free of grease, oil dirt, snow or ice. Steps and handholds must be clean and functional.
- All other guards and shields are correctly installed and in good condition.
- Hydraulic system components are properly secured and not damaged or leaking.
- Wheels and tires are not damaged or missing parts, tires are at the correct pressure, and lug nuts or bolts are at the correct torque.

Machine Attachment

Ensure all attachments are in operating condition. Check the following attachments as applicable:

- Mechanical attaching systems are correctly connected.
- Drawbar hitch pin with positive retention
- Safety tow chain
- 3 point hitch or other coupling/locking features
- Hydraulic hoses are connected and functioning properly.
- Hydraulic hoses are properly supported to avoid damage.

- Hydraulic functions operate as expected.
- Couplers are not leaking.
- Lighting devices such as warning flashers, turn signals, taillights, stop (brake) lights, and work lights are connected and functioning properly.

Machine Compatibility

Specifications of the tractor, skid steer, or windrower must be sufficient to operate the mower for all modes of operation and transport. Refer to the operator's manuals or contact the dealer for specifications. Check the following specifications as applicable:

- PTO shaft size and spline count
- PTO shaft rotational direction
- Mechanical attachment such as 3-point hitch, drawbar, or other coupling/locking features
- Hydraulic and/or electrical system performance and connection

Prepare for Safe Operation

Avoid Injury From Raised Equipment

Avoid possible crushing injury from falling mower or other raised equipment.

Before working near or under raised mower or equipment parts:

- Securely support or block up raised mower or equipment parts according to the operator's manual.
- Securely support, block up or lock up wings with approved locking devices or lower mower or equipment parts to the ground.
- Use transport locks when transporting mower on public roads.

⚠ WARNING! Prevent possible crushing injury from falling equipment. Hydraulic system or part failure could allow unsupported equipment to fall. **Do not go under raised equipment unless it is properly supported according to the operator's manual.**



Avoid crushing - block up or securely support mower

Pressurized Fluid Injection Hazard

⚠ WARNING! Accidental injection of pressurized fluid into the hands or body is dangerous and could result in death or serious injury. Pressurized fluids include oil, hydraulic fluid or water. **Use caution when checking fluid leaks as pressurized fluids can penetrate skin or eyes, causing serious personal injury.**



Pressurized fluid can inject into the body

If a leak is discovered:

- Ensure engine is turned off; relieve pressure in fluid system.
- Wear proper hand and eye protection.
- Visually examine the fluid lines in the vicinity of the leak for breaks or cracks. **Do not** use your hand to check for leaks.
- Repair or replace fluid lines per manufacturer's recommendation.

Prepare for Safe Operation

Fluid injection injuries are not always obvious. Victims have reported such injuries feel like a bee sting or splinter under the skin. If you suspect you have a fluid injection injury, do not take chances. Seek proper medical care immediately. Be sure attending medical professional understands that injury may be caused from a fluid injection. If any fluid is injected into the skin, it must be surgically removed within a few hours by a doctor familiar with this type of injury.



Wear proper hand and eye protection

Check the Cooling System

When checking the cooling system, follow the manufacturer's instructions to ensure the engine is turned off and cool to prevent the fan from unexpectedly starting. Ensure the coolers and engine compartment are clean and free from debris, which could ignite and cause a fire.

If the machine is air-cooled, be sure the cooling unit has an unobstructed air flow. If it is liquid-cooled, check coolant level (at overflow tank, if provided).

⚠ WARNING! Allow the radiator to cool before checking the level. Hot radiator fluids could escape as steam and burn you. (See page 44, **Engine Coolant Hazards.**)



Allow radiator to cool before removing cap slowly

Prepare for Safe Operation

Clean Up

Clean windows, lights, and safety signs.

Make sure the operator's area, steering levers, pedals, joysticks, steps, and grab handles are clean. Oil, grease, grass, leaves, needles, snow, ice, mud, or debris in these areas could cause you to slip and fall, or lose control of the machine. Clean your footwear of excess mud before entering the machine.

Remove all personal items or other objects from the operator's area. Secure these items in a toolbox or remove them from the machine.

Use Caution When Fueling

⚠ WARNING! Avoid injury from fire or explosion. **Never fill the fuel tank with the engine running, while smoking or when near an open flame.**

Never overfill the tank or spill fuel. If fuel is spilled, clean it up immediately.

Be sure to use the correct type and grade of fuel.

Ground the fuel funnel or nozzle against the filler neck to prevent sparks that could ignite fuel vapors. Be sure to replace the fuel fill cap, if equipped, when you are done.

Ultra-Low Sulfur Diesel (ULSD) Fuel Hazard

Avoid Static Electricity Risk When Fueling

⚠ WARNING! Ultra-Low Sulfur Diesel (ULSD) poses a greater static ignition hazard than earlier diesel formulations. Avoid death or serious injury from fire or explosion; **consult with your fuel or fuel system supplier to ensure the delivery system is in compliance with fueling standards for proper grounding and bonding practices.**

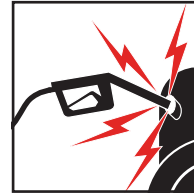

Static discharge during fueling can cause explosion



No smoking and no open flames

Prepare for Safe Operation

Exhaust Fumes in a Closed Space Can Kill

Vent exhaust and assure a flow of fresh air if an internal combustion engine is used in a closed space.

⚠ WARNING! Exhaust fumes from diesel, gasoline or LP gas engines can kill. **Do not breathe exhaust fumes from any kind of engine.**



Ventilate work area

Operating in Flammable/Explosive Atmospheres

⚠ WARNING! A standard machine equipped with a spark arrestor/spark arresting muffler cannot be operated in flammable or explosive atmospheres. Using them in flammable or explosive atmospheres can result in fires and/or explosions which could cause serious injury or death.

Use only an approved industrial/agricultural mower with a label designation of G, GS, D, DS, DY, LP, LPS, G/LP, or GS/LPS. See Code of Federal Regulations (OSHA) 29 CFR Part 1910.178 to determine permissible areas where these machines can be operated.



Do not operate in explosive/flammable atmosphere

Prepare for Safe Operation

Know the Working Area

Learn as much about your working area as possible.

Check at Ground or Floor Level

Before you operate, inspect the surface over which you will travel. Look for holes, slide areas, drop-offs, and obstacles such as rocks, stumps or utilities. Look for rough spots or hidden obstacles on surfaces which could cause a collision or loss of control. Look for oil spills, wet spots, and slippery surfaces. Check for location of creeks and gullies. Look for soft soil, deep mud, standing water or marshy areas. Watch for anything that might make you lose control or cause the machine to roll over.

Plan travel routes ahead of time, in order to make sure you can see and protect bystanders. Pick up debris that can puncture tires.

Plan Your Work

Correct unsafe conditions. Do not operate in problem areas where debris and obstacles cannot be removed or marked.

Analyze mowing area to determine:

- The most efficient mowing procedure.
- The height of the material to be mowed.
- Operating terrain conditions.
- How to best use forward mowing pattern.
- The potential for bystanders or passers-by to be exposed to thrown objects.

Check Overhead

Check the clearances of doorways, canopies, and overheads. Know exactly how much clearance you have under overhead power and telephone cables.

⚠ DANGER! Death or serious injury will result from touching or being near a machine that is in contact with or near an energized electrical source. **Never approach power lines with any part of the machine or load unless all local, state/provincial and federal (OSHA) required safety precautions have been taken.** Use caution because high voltage sources can arc without contact.

When working near power lines, you must assume all lines are energized.

Prepare for Safe Operation

Mount and Dismount Properly

Always use three-point contact when mounting or dismounting the machine. Three-point contact means one hand and two feet, or two hands and one foot, in contact with the machine at all times.

Never mount or dismount while carrying tools or objects that prevent three-point contact. Put parts or tools down. Maintaining proper contact, climb or dismount, and then pick up the object.

Face the machine when you enter or leave the machine.

Clean shoes and wipe hands. Clean steps and handholds of chemical residue, snow, ice, mud or oil.

During mounting and dismounting:

- Use handholds and step plates.
- Never use steering wheels, joysticks or controls as handholds.
- Never jump on or off the machine.
- Never mount or dismount from a moving machine.



Use three points of contact when mounting or dismounting

Warn Personnel Before Starting

Before starting, walk completely around the machine. **Make sure no one is under the machine, on it, or close to it.** Let others know you are starting up and do not start until everyone is completely clear of the machine. As the equipment operator, you are responsible for the safe use of the machine, so always make sure you have communicated your work plans to others on the site.

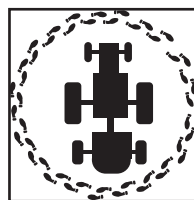

Before starting, walk completely around mower

Start Safely

Starting the Engine

⚠ WARNING! Start the engine from the operator's seat only. **Never attempt to start the engine by shorting across starter terminals or reaching the key from outside the operator's station.** The machine may move unexpectedly, which could cause death or serious injury to anyone in its path.

Know the exact starting procedure for your machine. See the manufacturer's operator's manual(s) for starting.

- Sit in the operator's seat and adjust the seat so you can operate all the controls properly.
- Fasten the seat belt, if equipped.
- Always keep cab doors closed and Operator Protective Structure (OPS) windows and screens in place.
- Familiarize yourself with warning devices, gauges and operating controls.
- Make sure controls are in the neutral/locked position.
- Check PTO disengagement.

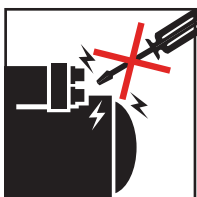

Never start engine by shorting across starter terminals

- Clear the area of all persons.
- Sound the horn.
- Start the engine following the instructions in the manufacturer's operator's manual(s).

If necessary to run the engine or operate the machine in an enclosed area, ensure there is adequate ventilation.

⚠ WARNING! Exhaust fumes can kill. **Do not breathe exhaust fumes!**

Starting Aids

If you have trouble starting the engine and need to use jumper cables, follow the instructions in manufacturer's operator's manual(s). **Jump-starting is a two-person operation.** The operator must be in the operator's seat when jump-starting so the machine will be under control when the engine starts.

⚠ WARNING! Improper jump-starting procedures may cause death or serious injury from a battery explosion or a run-away machine. **Always use proper jump-starting procedure.** (See page 46,

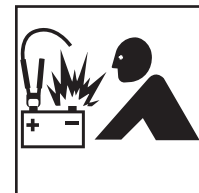

Start Safely

Battery Hazards.)

Ether/cold-start fluid is **HIGHLY FLAMMABLE**. Before using it, always read the instructions on the ether/cold-start fluid container and the instructions in the manufacturer's operator's manual(s).

⚠ WARNING! Avoid injury from explosion or fire. If the engine is equipped with a glow plug pre-heater or other intake manifold type pre-heater, follow manufacturer's instructions before using ether/cold-start fluid.

After Starting Engine

Observe gauges, instruments, and indicator lights to assure that they are functioning and their readings are within the operating range.

Run an Operating Check

Do not use a machine that is not in proper operating condition. It is your responsibility to check the condition of all systems and to run the check in a safe area.

Test Controls

Industrial/agricultural mowers come equipped with various control configurations, patterns, and operating modes, each with their own handling characteristics. Some have selectable or configurable controls, to suit personal preferences or specific applications.

Make sure that you know which control pattern you have selected and that you understand how the machine will handle when using that control pattern.

Make sure the machine is operating properly by doing the following:

- With the control levers or joysticks in neutral, test engine speed control.
- Operate each pedal, lever or joystick to make sure all functions are correct.
- Operate the travel control lever(s) or joysticks to ensure correct operation in forward and reverse. Test steering to the right and to the left, while moving slowly in a clear, safe area.
- Check the parking brake and service brakes according to the manufacturer's operator's manual(s).

⚠ WARNING! Before operating the machine under working conditions, **be certain you can control both speed and direction of the machine.** Any loss of control could result in death or serious injury.

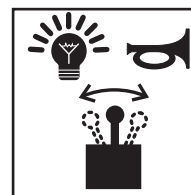

Operate instruments and controls smoothly

Operate Safely

Masked Visibility Areas

Machines have areas where the operator's visibility of the job site can be affected by the machine itself. ROPS posts, attachments, even items in the cab, could limit your view of the surrounding area and possibly mask hazards or people around you. These masked visibility areas vary from machine to machine, and it is very important that you are aware of these areas before operating your machine.

Follow these safety precautions to reduce the hazards posed by masked visibility areas:

- Pay particular attention when raising or lowering the mower or the attachment, because masked visibility areas can change.
- Look around the machine before operating. Objects near the machine and close to the ground can be difficult to see from the operator's station.
- Always look in the direction of travel, including reverse. A back-up alarm is no substitute for looking behind you when operating the machine in reverse.
- Keep bystanders away, even if your machine is equipped with a back-up alarm.

Remember These Rules

Stay in the operator's seat with the seat belt fastened when operating.

Make sure you have adequate visibility and sufficient lighting during operation.

Be in control of the machine at all times.

Remember the Other Person

Never allow an untrained or unqualified person to operate the machine. If operated improperly, this machine can cause death or serious injury.

⚠ WARNING! The industrial/agricultural mower is a one-person machine. Avoid death or serious injury—**never permit riders!**

⚠ WARNING! Keep clear of all rotating components. Wrapping or entanglement may result in serious injury or death.



Operate Safely

Be sure that everyone is in the clear, **at least 300 feet (92 m) away for rotary mowers, or 100 feet (31 m) for disc mowers**, and operate in accordance with federal, local, state/provincial laws or manufacturer recommendations that apply to this equipment and its use. It is important that you know and comply with all specific work site or employer rules. Awareness on your part can prevent accidents.

Back up Safely

Check that the back-up alarm, if equipped, is working properly. Remember, **a back-up alarm is not a substitute for looking to the rear when operating the machine in reverse.** Always look around before you back up the machine. Be sure that everyone is in the clear. Drive forward whenever possible. **ALWAYS LOOK IN THE DIRECTION OF TRAVEL.**

Follow Safe Operating Practices

Make these safe practices part of your daily routine:

- Keep your seat belt, if equipped, fastened.
- Operate the controls smoothly—don't jerk the steering levers or joysticks.
- Avoid sudden stops, starts or turns.
- Use care and good judgment.
- Never attempt to operate the controls unless properly seated in the operator's station.

⚠ WARNING! Avoid death or serious injury! **Keep your entire body inside the operator's station while operating the machine.** Never work with your head, arms, feet, or legs beyond the operator's station.

Operate Safely

Watch Out for Hazardous Working Conditions

Be alert for hazards. Know where you are at all times. Watch for branches, cables, or doorways.

Caution should be used when working along the tops of banks or slopes. Always operate the machine perpendicular to the bank. Keep away from the edge.

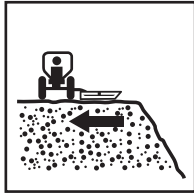

Operate perpendicular to banks – stay back from the edge

⚠ WARNING! Never operate the machine close to the edge of an overhang or gully. The edges could collapse or a slide could occur causing death or serious injury.

Use caution when working along runways, banks and slopes. Keep away from the edges of drop-offs.

When working near hazardous conditions, have a spotter work with you to look for hazards. Make certain they stay a safe distance from your machine.

Traveling on Job Site

Take it slow and easy when traveling through congested areas. Traffic courtesy pays off.

Give the right-of-way to loaded machines. Maintain a safe distance from other machines. Pass cautiously.

Don't obstruct your vision when traveling or working. (See page 24, **Masked Visibility Areas.**)

Travel Safely

When traveling over rough terrain, **SLOW DOWN** to prevent losing control.

Avoid steep slopes or unstable surfaces. Do not drive across an excessively steep slope under any circumstances. Before operating on slopes, check the surface conditions for adequate traction. Loss of traction can cause the machine to slide and tip.

⚠ WARNING! Avoid death or serious injury. Travel up and down slopes with the heavy end of the machine pointed uphill.

⚠ WARNING! Avoid death or serious injury. Make sure you can see where you are going.

Operate Safely

Rules of the Road

If the machine is to be driven or transported over the road, refer to the manufacturer's operator's manual for instruction.

Check local regulations for required equipment markings, lights, flashers, etc., while traveling on public roads. Lights are required on mowers that obscure tractor taillights and/or other warning lights.

When traveling on public roads or streets, obey all traffic regulations applicable to your machine.

Make sure lights and warning signs are in place and visible. Make sure a Slow Moving Vehicle (SMV) emblem and Speed Identification Sign (SIS), if applicable, is installed and visible to any vehicle approaching from the rear.

Find out if you must use an escort vehicle. Approach intersections with caution; observe speed and traffic control signs. Avoid panic stops and sharp turns.

Like any responsible operator, be considerate of other drivers. If traffic backs up behind you, it is a good idea to pull over periodically and allow traffic to pass when it is safe to do so.

Stop at all railroad crossings and look both ways before proceeding. Never park in traffic areas. If it is necessary to stop at night, pull off the road and set up flares or reflectors. When driving at night, use appropriate lights.

Watch Out for Obstacles

Adjust your speed to conditions. Avoid traveling over obstacles such as logs, tree stumps or rough terrain whenever possible.

Keep your machine under control.

Before entering underpasses, tunnels or bunkers, check for oncoming traffic or obstructions.



Obey traffic regulations

Operate Safely

Transporting Safety Tips

Always wear your seat belt when loading or unloading your machine from a transport device, such as a flatbed truck.

When transporting a machine, follow the manufacturer's recommended loading, tying down and unloading procedures.

Several precautions are applicable to all machines:

- Keep bystanders away.
- Load and unload on a level surface.
- Maintain proper visibility by loading or unloading in well-lit areas, and away from other vehicles, equipment or buildings.
- Block transport vehicle so it cannot move.
- Ensure trailer bed and ramps are in good condition.
- Use ramps of adequate size and strength, with a low angle and proper height.
- Rear of trailer must be blocked or supported.
- Keep trailer bed and ramps free of clay, oil, ice, snow, and other materials which can become slippery.
- Back the machine up the ramp onto the transport vehicle. If the machine is equipped with a heavy attachment it may be necessary to drive forward onto the transport vehicle.

- Cover or remove rear-facing SMV sign on the machine, if equipped, to avoid confusing drivers following the transport vehicle.
- Chain and block the machine securely for transport. Use tie-down points as marked on the machine by the manufacturer. Follow the manufacturer's instructions in the operator's manual for tying down.
- Unload the machine by driving off in the opposite direction; do not turn the machine around.

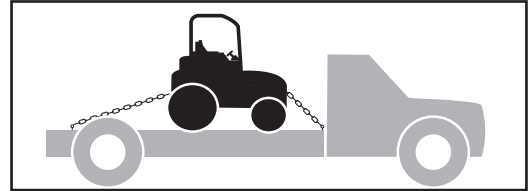

**Chain and block
mower securely
for transport**

Operate Safely

Power Takeoff (PTO) System

Be sure to operate the tractor at the mower's rated PTO rpm speed.

When operating a tractor with a transmission-driven PTO system, a rotary mower will have a significant flywheel effect and may continue to propel the tractor. This type of tractor should be equipped and operated as follows:

- Install a driveline equipped with an over-running clutch.
- Give yourself sufficient maneuvering room and time by anticipating turns, stops and speed reductions.

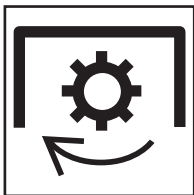

**Use proper
PTO speed**

Hitching Mower to Tractor

Three-point hitch-mounted mowers:

- Refer to mower and tractor manufacturer's operator's manuals.
- Place tractor's hydraulic power lift (rockshaft) selector lever in down position to avoid unexpected movement.
- Front-end weights may be needed to maintain steering control and front-end stability. Refer to the manufacturers' operator's manual(s).
- When backing the tractor up to the mower, NEVER allow anyone between the tractor and the mower.
- Attach the mower to the tractor three-point links and securely pin in position.
- Securely attach the driveline to the tractor PTO.
- Push and pull on the driveline to ensure it is locked onto the PTO shaft.
- Lower the master shield into place if it is movable.

Operate Safely

Pull-type hitch-mounted mowers:

- Refer to mower and tractor manufacturer's operator's manuals.
- Remove three-point hitch quick coupler, if equipped.
- Adjust tractor drawbar length for 540 or 1000 rpm PTO operation.
- When backing the tractor up to the mower, NEVER allow anyone between the tractor and the mower.
- Attach only to drawbar hitch.
- Properly attach the mower safety tow chain to the tractor.
- Securely attach the driveline to the tractor PTO. Push and pull on the driveline to ensure it is locked onto the PTO. Lower the master shield into place.
- Hook up the mower hydraulic hoses to the tractor.
- Make sure the wings, or raised mower decks, are supported by the cylinders before removing the transport locks. Never use force to release the transport or wing locks. The wings or decks could fall and crush you.



Confirm wings are supported before releasing locks

Skid steer-mounted mowers

- Refer to mower and skid steer loader manufacturer's operator's manuals.
- Lower the lift arms and title the loader's coupler forward.
- Drive the loader slowly forward until the top edge of the coupler is completely under the top flange of the mower attachment mounting frame.
- Tilt the coupler backward until the attachment is slightly off the ground. This will cause the mower attachment mounting frame to fit up against the front of the coupler.
- Engage the coupler pins or wedges. Check to be sure the coupler pins or wedges are fully engaged and locked to the mower.
- Hook up the mower hydraulic hoses to the loader.

Operate Safely

Make the Right Start

Mow only in daylight or good artificial light conditions.

Avoid serious injury or death from mower-thrown objects or blade contact:

- Keep chain shields, flexible or solid deflector shields or discharge chutes in place and in good repair.
- Keep bystanders at least 300 ft (92 m) from a rotary mower or 100 ft (31 m) from a disc mower during mowing operation.
- Never direct mower discharge toward anyone.
- Keep hands, feet and other body parts away from rotating parts, blades and discharge openings.
- Do not operate mower in transport position.

Do not approach a mower until all motion has stopped.

Mower PTO drive engagement:

- Raise mower to maximum cutting height.
- Engage PTO at low engine rpm.
- Increase engine rpm to mower's rated rpm PTO speed.
- Lower mower to desired cutting height.
- Stop and shut down immediately if the mower strikes an obstruction.
- Inspect and repair any mower damage before resuming mowing.
- Do not operate mower with severe vibrations or with unusual noise.

Avoid bending blades — Help prevent mower blades from bending or cracking by avoiding contact with solid objects. Mower blades are intended to cut grass, shrubs, woody vegetation and small trees and limbs. They are not intended to contact solid objects such as rocks, concrete or steel posts. Inspect the area prior to mowing. Remove or clearly mark any solid objects and mow around them.

Replace damaged blades! — Inspect the mower blade(s) daily or after hitting any solid object. IF a mower blade becomes damaged (bent, gouged or cracked) or worn more than 25 percent of the original size, it should be removed and replaced with a new blade. Always use the original manufacturer's blades. Aftermarket brand blades may not meet the mower manufacturer's strength, hardness and ductility requirements.

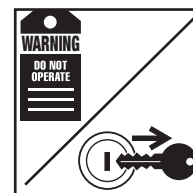

Do not operate a damaged mower

Operate Safely

Mower-Thrown Objects

Depending on the designed purpose, mowers are designed to cut grass, weeds, brush and crops. The mower blades have been designed and tested for rugged use. The mower blades, however, are not intended to contact solid objects like rocks, concrete or metal. Such impact can cause objects to be thrown. Bystanders should never be within 300 ft (92 m) of an operating rotary mower or within 100 ft (31 m) of an operating disc mower. Stop operation if anyone comes within the safety distance for the mower type.

Mower shielding is designed to reduce the risk of thrown objects and must be properly maintained and in place during mowing operations.



Watch out for
thrown objects

The risk of serious injury or death from thrown objects can be significantly reduced by following three rules. **If all of these safety rules are not followed, the mowing operation must be stopped.**

First — Inspect the area prior to mowing and remove stones, branches, wire, cable, metal, glass and other solid objects before operating. Any objects that cannot be removed must be clearly marked and carefully avoided by the operator.

In non-crop areas with grass and weeds high enough to hide objects that could be struck by the blades, inspect the area and remove or mark large debris or obstacles.

Mow the area at an intermediate height. Inspect the area closely and remove or mark any remaining debris or obstacles. Mow again at desired final height.

Second — Mower-thrown object shielding must be used when operating near roads, parks, populated areas or other areas where thrown objects could injure bystanders or damage property. Follow the manufacturer's operator's manual.

Third — Cross diagonally when mowing through ditches, sharp dips, and drops. Raise the mower to prevent the mower blades from hitting the ground.

Operate Safely

Disc Mowers — When using a disc mower it is important to know the area to be mowed. If the operator has mowed the field before and is familiar with all obstacles that may be present, it is sufficient to watch ahead of the mower path for any additional objects that may have entered the field. Be ready to stop or avoid any objects that could be hazardous if thrown by the mower. If you plan to mow an unfamiliar field and it is next to a traveled road or people may be within 100ft (31 m) of the mower you must inspect, and clean or mark the field.

Mowing In Reverse

Do not mow while traveling in reverse. Objects are more likely to be thrown and can travel further.

Shut off the PTO, wait for the blades to stop turning, raise the mower, and then back up.

Mow traveling in the forward direction.

Mowing Ground Speed

Proper ground speed depends on terrain conditions and grass type, density and height to be cut:

- Follow manufacturer's recommended operating speeds.
- Use slower ground speed for mowing tall, dense grass.
- Use faster ground speed for mowing medium height, thin grass and under smooth terrain conditions.
- Use slower ground speed for mowing in rough, sloping or unfamiliar terrain.

Disc mowers are designed to use faster ground speeds for operating in fields clear of debris and surface hazards.

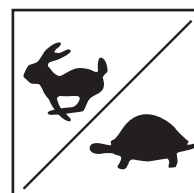

Use proper
ground speed

Operate Safely

Extremely Tall Grass Mowing

You may need to mow extremely tall, non-crop grass twice. (See page 32, **Mower-Thrown Objects**.)

First mowing pass:

- Shut the mower and tractor down using proper equipment shut down practice before dismounting tractor. (See page 38, **Safe Shut Down**.)
- Inspect the area and remove or mark debris and obstacles.
- Cut grass higher (10-15 inches/ 250–400 mm) to avoid hidden objects.

Second mowing pass:

- Shut the mower and tractor down using proper equipment shut down practice before dismounting tractor.
- Inspect the area and remove or mark debris and obstacles.
- Cut grass at desired height and, when possible, 90 degrees to the first mowing pass.

Watch Equipment Clearances

Three-point hitch and side-mounted mowers have a larger turning arc than pull-type mowers. Allow sufficient clearance for mower swing while turning.

Do not allow bystanders near the tractor and mower when moving or transporting the tractor and mower.

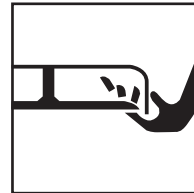

Stop blade before unclogging

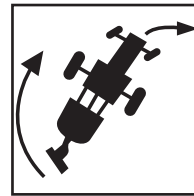

Provide adequate clearance for mower swing

Operate Safely

Under Mount Mower Safety Practices

When mowing with an under mount mower:

- Keep removable discharge chute in place and over discharge opening.
- Never stand on a mower housing when the tractor engine is operating.
- Distribute grass clippings with discharge chute facing mowed area.
- Before clearing a clogged mower or discharge chute, shut down your machine using proper equipment shut down practice. (See page 38, **Safe Down**.)

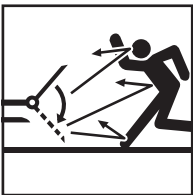

Keep chute in place



Do not approach energized power lines

Wing or Boom Mower Overhead Obstruction Hazards and Risks

Check for overhead obstructions with raised wing or boom mowers to avoid serious injury or death by contact with:

- Electrical power lines and apparatus.
- Low tree limbs.
- Other overhead obstructions.
- Maintain specified distance from power lines and apparatus. Never approach energized power lines or apparatus with any part of your machine unless all local, state/provincial and federal (OSHA) required safety precautions have been taken. Use caution.

⚠ DANGER! Avoid electrocution or serious injury from contact with or inadequate clearance to energized power lines or apparatus. Do not allow the machine or attachment to approach or contact any power line. Do not approach or touch any machine in contact with a power line.

Operate Safely

Wing and Side Mount Mowers Safety Practices

Raised wing positions reduce shielding protection and increases the thrown object and blade contact hazard risks.

Avoid possible serious injury or death by thrown objects or blade contact from raising and lowering wings during mowing operations:

- Do not mow with bystanders within 300 ft (92 m) of a rotary mower or within 100 ft (31 m) of a disc mower.
- Be sure no one is near mower while raising or lowering wings.
- Shut off the PTO and wait for all rotating elements to stop before raising the mower deck or wing section.
- Only raise wing to clear objects in the mowing path or to match ground slope.
- Lower raised wing to ground after clearing object or ground slope conditions.
- Stop mowing if anyone approaches closer than the safety distance for the mower type.

Ditch Bank Mowing Safety Practices

Use care when mowing ditch banks. Watch for washouts, eroded areas and mowing obstructions along the ditch banks. Hitting obstructions with side-mount or boom mowers may swerve the tractor's front end toward the ditch.

Raised wing and boom mower ditch bank operations may reduce the mower's thrown object shielding effectiveness for the mower operator's protection.

- Use enclosed ROPS cabs, special protective enclosures and other operator shielding available from the manufacturer when performing these operations.
- Inspect mowing area and remove or mark all foreign objects and debris to be avoided by mower.

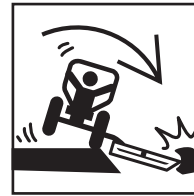

Avoid hitting obstructions

Operate Safely

Uneven Terrain Mowing Safety Practices

Tractor and mower stability is reduced on slopes and uneven terrain.

As in all conditions when mowing, use tractors equipped with ROPS and seat belt. **Make sure the ROPS are raised and locked in place and always wear your seat belt.**

Prevent tractor and mower overturns and maintain equipment stability control:

- Review tractor and mower operator's manuals for operating safety practices on slopes and uneven terrain conditions. Explain the practices to those users and operators who cannot read.
- Avoid extremely steep slope operations.
- Use care to maintain control over the equipment when operating in these conditions.
- Increase tractor stability by adding wheel weights, ballast and increasing wheel spacing to maximum. Refer to operator's manual for recommendations.
- Maintain minimum ground speed.
- Make wide and gradual turns.
- Avoid sudden starts, stops, and turns when operating up, down, or across slopes.

- Do not raise rear-mount or side-mount mowers or mower wings from the ground during these operations.
- Keep alert for holes, bumps, ruts, rocks, stumps or other obstructions that could overturn the machine.
- Avoid slippery ground conditions that could cause loss of control and overturn of tractor and mower.
- Avoid bottoming and striking the ground by diagonal crossing of sharp dips and drops.

Use care in maintaining equipment stability during all uneven terrain and slope mowing operations. You are the final judge as to any slope that can be safely negotiated.

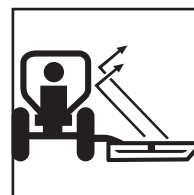

Use enclosed ROPS cabs or protective enclosures

Shut Down Safely

Select a Proper Parking Site

When shutting down, park the machine in a designated area out of traffic, select level ground whenever possible. Lower raised equipment to the ground. If you must park on a slope or incline, position the machine at right angles to the slope, engage the parking brake, and block the wheels.

⚠ WARNING! Avoid death or serious injury from unintended movement of the machine. **Never leave a machine unattended with the engine running.**

Safe Shutdown

The detailed shutdown procedure is given in your manufacturer's manual(s). In general, this includes:

- Stop machine.
- Ensure all wheels are on the ground.
- Position controls in neutral or locked position.
- Engage parking brake.
- Idle engine for short cool-down period.
- Disengage PTO clutch and transmission drive.
- Lower mower to ground.
- Lower wings of wing mowers to ground.
- Stop engine and remove ignition key, if equipped.
- Cycle hydraulic controls to eliminate pressure.

- Raise operator seat/restraint bar(s), if equipped.
- Unbuckle seat belt/restraint.
- Lock covers and enclosures, if equipped.
- Shut off master electric switch, if equipped.
- When you leave the machine, wait for all moving parts to stop before dismounting. Always maintain three-point contact with the steps and grab handles. Face the machine as you dismount. Never jump off machine.
- Block wheels if on a slope or incline.

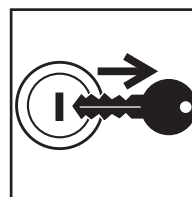

Shut engine off,
remove key

Perform Maintenance Safely

Know What You're Doing

Maintenance on this type of machine is not for inexperienced or untrained personnel. It can be hazardous unless performed properly. Be sure you have the necessary skill, information, correct tools, and proper equipment to do the job safely.

Be sure to maintain the equipment according to the manufacturer's instructions. Regularly check the operation of the protective and safety devices.

Do not perform any work on a machine unless you are authorized and qualified to do so.

If you have been authorized to perform maintenance, **read the manufacturer's operator's, maintenance, and service manuals.** Study the instructions: check the lubrication charts, examine all the instruction messages on the machine.

Protect Yourself

Wear all the proper personal clothing and all the PPE issued to you or called for by job conditions.

You may need:

- Hard hat
- Safety shoes
- Safety glasses, goggles or face shield
- Heavy duty gloves
- Hearing protection
- Reflective clothing
- Wet weather gear
- Respirator or filter mask

Wear whatever is needed to protect yourself. Do not take chances.

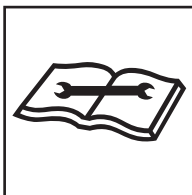

Maintain equipment

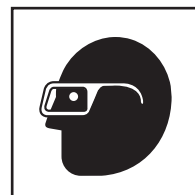

Perform Maintenance Safely

⚠ WARNING! Avoid death or serious injury from entanglement. **Do not wear loose clothing or accessories. Stay away from all rotating components when the engine is running.** Contact, wrapping or entanglement with rotating or moving parts could result in death or serious injury.

Wear a proper chemical resistant apron and chemical resistant gloves when working with corrosives. Wear cut resistant gloves and safety shoes when handling wooden blocks or sharp-edged metal.

Always use safety glasses, goggles or a face shield. They provide eye protection from fluids under pressure, during grinding and while servicing batteries. Protection is also needed from flying debris, liquids and loose material produced by equipment, tools and pressurized air/water.

Wear a face shield and follow manufacturer's instructions when you disassemble spring-loaded components or work with battery acids. Keep pockets free of all objects that could fall out and drop into machinery.

Handle tools and heavy parts sensibly, with regard for the safety of yourself and others. Lower items; don't drop them.

Mower Parts and Your Safety

Mower manufacturers use specific fasteners and specially designed parts to meet mowing operations requirements. Critical parts such as self-locking blade bolts, blades, pins, shields and other special items have specific strength, design and fit requirements for the make and model mower you are using.

Avoid possible death and serious injury from unapproved parts or modifications:

- Do not substitute common hardware for original manufacturer's blade bolts or other special part items.
- Do not substitute blades, pins shields or other critical parts.
- Do not use higher strength bolts to replace original manufacturer's shear bolts.



Avoid rotating parts

Perform Maintenance Safely

Prepare the Work Area

- Position the machine in a level area out of the way of other working equipment.
- Make sure there is adequate light, ventilation and clearance.
- Remove oil, grease or water to eliminate any slippery surfaces.
- Clean around the area to be serviced to minimize contamination.

Prepare the Machine

Stored energy sources (electrical, mechanical, hydraulic, pneumatic, chemical, thermal, etc.) must be controlled or reduced to a practical minimum before performing any maintenance, repair, or service procedures.

Safety practices to prevent potential injuries from energy-releasing sources include:

- Disengage PTO before shutting off engine
- Place controls in NEUTRAL or LOCKED position before shutting off engine
- Set parking brake or block wheels.
- Allow all moving parts to stop.
- Lower mower to the ground.
- Lower wings to the ground on wing mowers.

- Shut off engine.
- Follow your manufacturer's recommendation for relieving hydraulic system pressure.
- Lock ignition, remove key, if equipped, and take it with you.
- Look and listen for evidence of moving parts before dismounting.
- Shut off master electrical switch, if equipped.
- Securely support or block up machine before working underneath machine or other lifted components.
- Securely support, block up, or lock up other components with approved locking devices before working near or underneath them.
- Relieve pressure before disconnecting or disassembling any pressurized system.
- Block or relieve spring pressure before disassembling any spring-loaded mechanism.
- Avoid flames, sparks, or smoking near any fuel, hydraulic fluid or other flammable material such as mowing debris.



Avoid falls, clean slippery surfaces

Perform Maintenance Safely

Attach a “DO NOT OPERATE” warning tag to the control levers. Lockout/tagout the unit according to the manufacturer’s operating manual. If there is a key, remove it and take it with you.

Install approved support device(s) when working under or near raised equipment.

⚠ WARNING! Unsupported raised machines or other equipment may drop unexpectedly. **Never go under equipment when raised unless supported by an approved support device(s).** Death or serious crushing injury could result from falling equipment.

Remove only guards or covers that provide access to the area being serviced. Replace all guards and covers when work is complete.

⚠ WARNING! Avoid injury or death. **Never work on machinery with the engine running unless instructed by the manufacturer’s manuals for specific service.**



Use a “DO NOT OPERATE” tag

Common Maintenance Safety Practices

Use Proper Ventilation

If it is necessary to run an engine in an enclosed area, remove the exhaust fumes from the area with an exhaust pipe extension.

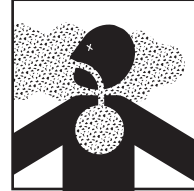

Ventilate work area

⚠ WARNING! Exhaust fumes contain carbon monoxide which could be deadly if inhaled. **Never operate any type of engine without proper ventilation. EXHAUST FUMES CAN KILL.**

Perform Maintenance Safely

Use Jacks and Hoists Carefully

Safety stands or blocks must be located on a rigid part of the machine. Do not position stands under axles or wheel supports that may rotate.

⚠ WARNING! Prevent crushing injury. **Never use concrete blocks for supports. They could collapse under even light loads which may cause serious injury or death.**

If you must work beneath raised equipment, always use hoists, jack-stands or other rigid and stable supports designed and approved for the intended load. When using jacks or hoists always be sure they are adequately supported.

Make sure the hoists or jacks you use are in good repair. Never use jacks with cracked, bent, or twisted parts. Never use frayed, twisted or pinched cables. Never use bent or distorted hooks.



Avoid crushing, use proper support for raised equipment



No smoking and no open flames

Fuel Hazards

⚠ WARNING! Avoid serious injury or death. **Always use approved fuel containers and/or fuel dispensing equipment to reduce the risk of explosion or fire.**

Always observe these practices to reduce the possibility of a serious accident:

- Shut off engine and ignition during refueling.
- Turn off all electrical switches.
- Ground the fuel nozzle against the filler neck
- Keep sparks and open flames away from fuel. Do not smoke while refueling or when handling fuel containers.
- Do not cut or weld on or near fuel lines, tanks or containers.
- Do not overfill the tank or spill fuel. Clean up spilled fuel immediately.

Perform Maintenance Safely

Ultra-Low Sulfur Diesel (ULSD) Hazard

⚠ WARNING! Ultra-Low Sulfur Diesel (ULSD) poses a greater static ignition hazard than earlier diesel formulations with higher sulfur content. Avoid death or serious injury from fire or explosion; **consult with your fuel or fuel system supplier to ensure the delivery system is in compliance with fueling standards for proper grounding and bonding practices.**

Engine Coolant Hazards

⚠ WARNING! Avoid serious injury or death. Liquid cooling systems build up pressure as the engine gets hot, so **use caution before removing the radiator cap.**

- Stop the engine and wait for the system to cool.
- Wear protective clothing and safety glasses.
- Turn the radiator cap slowly to the first stop to allow the pressure to escape before removing completely.



Allow radiator to cool before removing cap slowly

Hydraulic System Hazards

Be sure to follow manufacturer's instructions for relieving fluid pressure before performing any maintenance. The hydraulic system is pressurized whenever the engine is on and may hold pressure even after the engine is shut off. Cycle hydraulic controls, including auxiliary hydraulic control (if equipped), after the engine is shut off.



Check for leaks and inspect hoses

During inspection of the hydraulic system:

- Wait for fluid to cool before disconnecting the lines. Hot hydraulic fluid can cause **severe burns**.
- Wear appropriate eye protection. Hydraulic fluid can cause permanent eye injury.
- When venting or filling the hydraulic system, loosen the filler cap slowly and remove it gradually.
- **Never** reset any relief valve in the hydraulic system to a pressure higher than recommended by the manufacturer.

Perform Maintenance Safely

Pressurized Fluid Injection Hazard

⚠ WARNING! Accidental injection of pressurized fluid into the hands or body is dangerous and could result in death or serious injury. Pressurized fluids include oil, hydraulic fluid, water or fuel. **Use caution when checking fluid leaks as pressurized fluid can penetrate skin or eyes, causing serious personal injury.**

If a leak is discovered:

- Ensure engine is turned off; relieve pressure in fluid system.
- Wear proper hand and eye protection.
- Visually examine the fluid lines in the vicinity of the leak for breaks or cracks. **Do not** use your hand to check for leaks.
- Repair or replace fluid lines according to the manufacturer's recommendations.



Pressurized fluid can inject into the body

Fluid injection injuries are not always obvious. Victims have reported such injuries feel like a bee sting or splinter under the skin. If you suspect you have a fluid injection injury, do not take chances. Seek proper medical care immediately. If any fluid is injected into the skin, it must be surgically removed within a few hours by a doctor familiar with this type of injury.

Electrical System Hazards

Light Bulbs and Illumination

Some machines are equipped with High-Intensity Discharge (HID) Xenon light bulbs which operate at very high voltage. Do not begin installation of HID-Xenon lamps unless the lamps are turned off, the engine is turned off, the key is removed (if equipped), and you are wearing appropriate eye protection.

⚠ WARNING! **Do not look directly into HID-Xenon lamps.** Eye damage could occur.

Wear gloves and safety glasses when handling bulbs. Dangerous voltage sparks may occur and cause injury or damage to the connector. See manufacturer's warnings packaged with replacement bulbs.

Perform Maintenance Safely

Before working on the electrical system, disconnect the battery cable(s).

- Remove the battery negative (-) cable(s) first.
- When reconnecting the battery, connect the battery negative (-) cable(s) last.

Battery Hazards

The liquid in batteries contains acid, which is a POISON and could cause SEVERE CHEMICAL BURNS.

Avoid injury:

- Wear a face shield to prevent contact with your eyes.
- Wear chemical-resistant gloves and clothing to keep electrolyte off your skin and regular clothing.

⚠ WARNING! Liquid from the battery will damage eyes or skin on contact. **Always wear a face shield to avoid liquid in eyes.**

If liquid from the battery contacts your eyes, flush immediately with clean water and get medical attention. Wear chemical-resistant gloves and protective clothing to keep liquid off your skin. If liquid contacts exposed skin or clothing, wash off immediately with clean water. If liquid is ingested, drink large quantities of water or milk. DO NOT induce vomiting. Seek medical attention immediately.

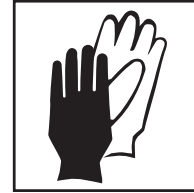

Wear hand protection

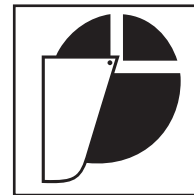

Wear face protection

Perform Maintenance Safely

Avoid Explosion

⚠ WARNING! Avoid serious injury from explosion. Lead-acid batteries produce extremely explosive gases especially when being charged. **Keep arcs, sparks, flames and lighted tobacco away.**

- **Do not** smoke near batteries.
- Keep batteries away from arcs, sparks and open flames.
- Provide adequate ventilation.

Never check the battery by placing a metal object across the battery posts. The resulting spark could cause an explosion.

⚠ WARNING! Avoid serious injury from battery explosion. **Do not charge a battery or jump-start the engine if the battery is frozen.**

Warm to 60°F (15.5°C) or the battery may explode and could cause serious injury.

Safety rules during battery jump-starting:

- Follow the instructions for proper battery jump-starting, as specified in the manufacturer's manual.
- Be sure the machines are not touching.

- Observe the polarity of the batteries and connections.
- Make the final cable connection to the engine or the farthest ground point away from the battery. Never make the final connection at the starter or dead battery. Sparks may ignite the explosive gases present at the battery.
- When disconnecting cables, remove the cables in reverse order of connection (e.g., final connection first).

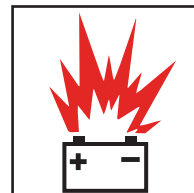

Avoid sparks and open flames near batteries

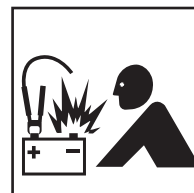

When jump-starting, observe polarity and make final connection at ground point

Perform Maintenance Safely

Tire and Wheel Maintenance

Check your tires and wheels daily because the stability of the machine can be dramatically affected by tire pressure or damage to tires or wheels.

Check tires for:

- Correct pressure
- Cuts and bulges
- Nails or other punctures
- Uneven or excessive wear
- Condition of valve stems and caps

Check wheels for:

- Damage to the rims
- Missing or loose lug nuts or bolts
- Misalignment

All tire service should be performed by a qualified tire service center or by an authorized service person who has been properly trained in the procedures and use of safety equipment designed for tire servicing.

⚠ WARNING! The types of wheels and tires usually found on this equipment require special care when servicing to prevent death or serious injury. **Do not inflate the tires above the recommended pressure.**

Keep wheel lug nuts tightened to manufacturer's recommendations.

An increase in tire pressure during operation is normal, and should NOT be reduced.

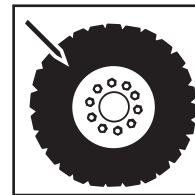

Check tires and wheels for damage

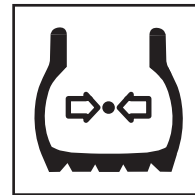

Maintain proper tire pressure

Perform Maintenance Safely

Never reinflate a tire that has been run flat or seriously under-inflated without removing the tire from the rim. Have the tire and rim closely inspected for damage before remounting.

When adding air to a tire, do so from a distance. Always use a long hose with a self-attaching chuck; stand away from the tire sidewall and to one side as far as possible.

Do not inflate tires with flammable gases or from systems using an alcohol injector.

Never cut or weld on a rim with an inflated tire mounted on it. This could cause explosive decompression.

Check that the tire size and rim are correctly matched.

When replacing the tires, ensure the tires are of the appropriate rating specified by the manufacturer.

⚠ WARNING! Avoid death or serious injury. **Always use a safety cage or cable restraints when inflating a repaired tire.**

Tires should not be operated at speeds higher than their rated speed.

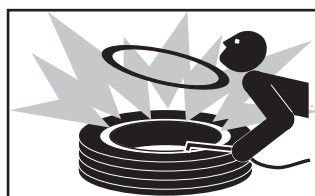

Avoid tire explosion

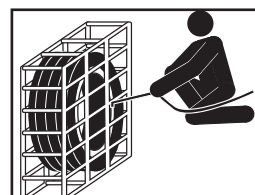

Use safety devices when inflating tires

Perform Maintenance Safely

Mower Blade Maintenance

Do not take chances using damaged or bent blades. The mower manufacturers from the Association of Equipment Manufacturers (AEM) and the Farm Equipment Manufacturers Association (FEMA) advocate that you do not reuse, straighten, hard face or weld mower blades. Death or serious injury could result if a broken blade is thrown from a mower.

It takes a great amount of impact force to bend the blade. This impact force often results in the blades being gouged or chipped. After a blade is damaged by a gouge or chip a blade failure is much more likely to occur. When a blade is severely bent, a microscopic crack may be created in the blade. Straightening the blade does not remove or repair this crack, but may cause additional cracks. Additional stresses during mowing operations can result in an unexpected blade failure.

⚠ WARNING! Using a damaged or straightened mower blade can result in the blade breaking and being thrown into the operator or a bystander causing death or serious injury. The price of a new blade is small compared to the potential for the serious injury that could result from a bent or broken blade being thrown from the mower.

Roll-Over Protective Structure (ROPS) and Falling Object Protective Structure (FOPS) Safety Precautions

Do not remove the ROPS/FOPS except for service. Reinstall all parts correctly before allowing the machine back into service.

Do not modify ROPS/FOPS in any manner. Unauthorized modifications such as welding, drilling, cutting or adding attachments could weaken the structure and reduce your protection. Replace ROPS/FOPS if subjected to rollover or damage. Do NOT attempt to repair them. See the manufacturer's manual(s) for complete instructions and inspection requirements.

Perform Maintenance Safely

Complete Service and Repairs Before Machine is Released

Tighten all bolts, fittings, and connections to torques specified by the manufacturer.

Inspect for leftover components such as cotter pins, washers, lock nuts, etc., after completing service. Replace any missing parts.

Start the engine and check for leaks. (See page 44, **Hydraulic System Hazards**.) Operate all controls to make sure the machine is functioning properly. Test the machine if necessary. After testing, shut down and check the work you performed.

Recheck all fluid levels before releasing the equipment for operation.

All parts should be inspected during repair and replaced if worn, cracked or damaged. Excessively worn or damaged parts could fail and cause injury or death.

Install all guards, covers, and shields after servicing. Refill and recharge pressure systems only with manufacturer-approved or recommended fluids.



Pressurized fluid can inject into the body

Checklist	
<input checked="" type="checkbox"/>	_____
<input checked="" type="checkbox"/>	_____
<input checked="" type="checkbox"/>	_____
<input type="checkbox"/>	_____
<input type="checkbox"/>	_____

Verify service work when completed

Notes

A Final Word to the User

You have just finished reading the AEM Industrial/Agricultural Mower Safety Manual. It is impossible for this manual to cover every safety situation that you may encounter on a daily basis. Your knowledge of these safety precautions and your application to the basic rules of safety will help to build good judgment in all situations. Our objective is to help you develop, establish, and maintain good safety habits to make operating an industrial or agricultural mower easier and safer for you.

Many pictorials in this safety manual can be downloaded at <http://pictorials.aem.org>.

For additional publications, visit our website at www.safetymaterials.org.

Palabras finales para el usuario

Acaba de terminar de leer el Manual de Seguridad de la segadora agrícola/industrial de AEM. Resulta imposible abarcar en este manual todas las situaciones de seguridad que podrían presentarse a diario. Su conocimiento de estas precauciones de seguridad y el cumplimiento con las normas de seguridad básicas le ayudarán a desarrollar un criterio sensato en todas las situaciones. Nuestro objetivo es ayudarlo a desarrollar, establecer y mantener buenos hábitos de seguridad para hacer que el uso de la segadora agrícola o industrial resulte más sencillo y sea más seguro para usted.

Muchas de las ilustraciones que figuran en este manual de seguridad pueden descargarse desde <http://pictorials.aem.org>.

Si desea conocer otras publicaciones, visite nuestro sitio web: www.safetymaterials.org.

Realizar el servicio de mantenimiento de manera segura

Precauciones de seguridad

de la estructura de protección

contra volcaduras (ROPS) y de la

estructura protectora contra objetos

que caen (FOPS)

No elimine los sistemas ROPS/FOPS, salvo que deba realizarse un mantenimiento de servicio. Vuelva a instalar todas las piezas correctamente antes de la puesta en marcha de la máquina.

No modifique de ninguna manera los sistemas ROPS/FOPS. Las modificaciones no autorizadas, por ejemplo, soldaduras, perforaciones, cortes o agregado de accesorios podrían debilitar la estructura y reducir su protección. Reemplace los sistemas ROPS/FOPS si sufrieron volcaduras o se dañaron. NO intente repararlos. Consulte los manuales del fabricante para obtener información sobre las indicaciones completas y los requisitos de inspección.

Mantenimiento de la cuchilla

de la segadora

No corra riesgos utilizando cuchillas dañadas o dobladas. Los fabricantes de segadoras de la Asociación de fabricantes de equipos (AEM) y la Asociación de fabricantes de maquinaria agrícola (FEVA, por sus siglas en inglés) recomiendan que no se reutilicen, enderrecen, endurezcan o suelden las cuchillas de las segadoras. Si una cuchilla rota sale expulsada de una segadora, puede producirse la muerte o la aparición de lesiones graves.

Se necesita una gran cantidad de fuerza de impacto para doblar la cuchilla. Esta fuerza de impacto a menudo hace que las cuchillas se rajen o astillen. Después de que una cuchilla se daña por una rajadura o astillado, es mucho más probable que ocurra una falla de esta. Cuando una cuchilla está severamente doblada, puede crearse una grieta reparar esta grieta, pero puede generar grietas adicionales. Esfuerzos adicionales durante las operaciones de corte pueden provocar una falla inesperada de la cuchilla.

!ADVERTENCIA! Utilizar una cuchilla de segadora dañada o enderezada puede provocar que esta se rompa o sea expulsada en dirección del operador o un transeúnte, y cause la muerte o lesiones graves. El precio de una cuchilla nueva es bajo en comparación con el riesgo de lesiones graves que podrían resultar de una cuchilla doblada o rota que sea expulsada desde la segadora.

Realizar el servicio de mantenimiento de manera segura

Reparaciones y servicio

completo antes de autorizar

el uso de la máquina

Ajuste todos los pernos, los accesorios y las conexiones a las torsiones que indique el fabricante.

Fíjese que no hayan quedado componentes olvidados, por ejemplo, pasadores de chaveta, arandelas, contratueras, etc., después de realizar el servicio. Reemplace las piezas que faltan.

Arranque el motor y fíjese que no haya fugas. (Consulte la página 44, **Peligros del sistema hidráulico**). Opere todos los controles para asegurarse de que la máquina esté funcionando correctamente. Pruebe la máquina si fuese necesario. Después de probarla, apáguela y revise el trabajo que realizó.

Vuelva a controlar todos los niveles de fluidos antes de autorizar el uso del equipo.



El fluido presurizado
puede penetrar
en el cuerpo.

Lista de verificación	
<input type="checkbox"/>	<input type="checkbox"/>
<input type="checkbox"/>	<input type="checkbox"/>
<input checked="" type="checkbox"/>	<input checked="" type="checkbox"/>
<input type="checkbox"/>	<input type="checkbox"/>
<input type="checkbox"/>	<input type="checkbox"/>
<input type="checkbox"/>	<input type="checkbox"/>

Una vez completado,
verifique el servicio
de mantenimiento.

Se deben inspeccionar todas las piezas durante la reparación y reemplazarse si están gastadas, dañadas o con rajaduras. Las piezas muy gastadas o dañadas podrían fallar y provocar lesiones o la muerte de una persona.

Instale todas las protecciones, las cubiertas y las carcasas después de realizar el servicio de mantenimiento. Vuelva a llenar y recargar los sistemas de presión solo con los fluidos que aprueba o recomienda el fabricante.

Realizar el servicio de mantenimiento de manera segura

Mantenimiento de neumáticos y ruedas

Verifique sus neumáticos y ruedas diariamente ya que la estabilidad de la máquina puede verse sumamente afectada por la presión de los neumáticos o daños en los neumáticos o las ruedas.

Verifique en los neumáticos lo siguiente:

- Presión correcta
- Cortes y protuberancias
- Clavos u otras perforaciones
- Desgaste desparejo o excesivo
- Estado de los vástagos y tapas de válvulas

Verifique en las ruedas lo siguiente:

- Daños en los rines
- Tuercas o pernos de rines flojos o faltantes
- Desalineación

Todo el servicio de los neumáticos debe realizarse por un centro de servicio de neumáticos calificado o por personal de servicio autorizado debidamente capacitado sobre los procedimientos y el uso del equipo de seguridad diseñado para el servicio de mantenimiento de neumáticos.

Realizar el servicio de

mantenimiento de manera segura

Al reemplazar los neumáticos, asegúrese de que sean del valor nominal especificado por el fabricante.

¡ADVERTENCIA! Evite las lesiones graves o la muerte de una persona. **Siempre utilice una jaula de seguridad**

o sujeciones de cables al inflar un neumático reparado.

Los neumáticos no deben operarse a velocidades superiores a su velocidad nominal.

No infle los neumáticos con gases inflamables o con sistemas que utilizan un inyector de alcohol.

Nunca corte ni suelde en un rin con un neumático

inflado montado en él. Esto podría causar una

descompresión explosiva.

Verifique que el tamaño del neumático y el rin coincidan.



Evite que exploten los neumáticos

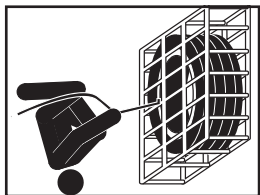

Use dispositivos de seguridad al inflar los neumáticos.

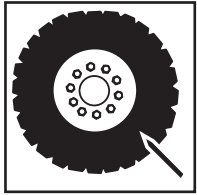

Verifique que los neumáticos y las ruedas no estén dañados



Mantenga la presión de neumáticos adecuada

¡ADVERTENCIA! Los tipos de ruedas y neumáticos que se suelen encontrar en este equipo requieren un cuidado especial al realizar el servicio de mantenimiento para evitar lesiones graves o la muerte. **No infle los neumáticos por encima de la presión recomendada.** Mantenga las tuercas de rines apretadas según las recomendaciones del fabricante. Un aumento en la presión de los neumáticos durante la operación es normal, y NO se debe reducir.

Realizar el servicio de mantenimiento de manera segura

Antes de trabajar en el sistema eléctrico, desconecte los cables de la batería.

- Retire primero los cables negativos (-) de la batería.
- Al volver a conectar la batería, conecte en última instancia los cables negativos (-) de la batería.

Peligros de la batería

El líquido de las baterías contiene ácido, que es un VENENO y podría provocar QUEMADURAS QUÍMICAS GRAVES.

Evite las lesiones:

- Use una máscara de protección facial para evitar el contacto con los ojos.
- Use vestimenta y guantes resistentes a las sustancias químicas para mantener los electrolitos alejados del cuerpo y de la vestimenta de uso diario.

¡ADVERTENCIA! Si el líquido de la batería entra en

contacto con los ojos o la piel, les ocasionará un daño.

Siempre use una máscara de protección facial para

evitar que el líquido entre en contacto con los ojos.



Utilice protección para las manos.



Utilice protección para el rostro.

Si el líquido de la batería entrara en contacto con los ojos, láveselos de inmediato con agua limpia y busque atención médica. Use vestimenta de protección y guantes resistentes a las sustancias químicas para mantener el líquido alejado de la piel. Si el líquido entra en contacto con la vestimenta o la piel expuestas, lávese de inmediato la piel y límpiese de inmediato la vestimenta con agua limpia. Si se ingiere líquido, beba una cantidad abundante de agua o leche. NO induzca el vómito. Busque atención médica de inmediato.

Evite las explosiones

¡ADVERTENCIA! Evite las lesiones graves a causa de las explosiones.

Las baterías de plomo y ácido generan

gases sumamente explosivos, en especial, cuando se cargan.

Mantenga lejos los arcos, las chispas, las llamas y los

cigarrillos encendidos.

• No fume cerca de las baterías.

• Manténgalas alejadas de los arcos, las chispas y las llamas abiertas.

• Proporcione una ventilación adecuada.

Nunca revise la batería colocando un objeto de metal a lo largo de los postes de la batería. La chispa que se genere

podría provocar una explosión.

¡ADVERTENCIA! Evite las lesiones graves a causa de las explosiones de la batería. **No cargue una batería ni arranque el motor si la batería está congelada.**

Llévela a una temperatura de 60 °F (15,5 °C) o la batería

podría explotar y provocar lesiones graves.

Normas de seguridad durante el arranque de la batería:

• Siga las indicaciones para arrancar adecuadamente

la batería, según se indica en el manual del fabricante.

• Asegúrese de que las máquinas no se toquen.

• Observe la polaridad de las baterías y las conexiones.

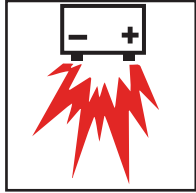

Evite las chispas y las llamas abiertas cerca de las baterías

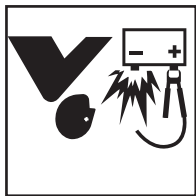

Al arrancar la batería, observe la polaridad y realice la conexión final en el punto de la puesta a tierra.

- Realice la conexión final de los cables al motor o al punto de la puesta a tierra más alejado de la batería. Nunca realice la conexión final en el motor de arranque o la batería muerta. Las chispas podrían causar combustión de los gases explosivos que se encuentran en la batería.
- Al desconectar los cables, retírelos en el orden inverso de la conexión (es decir, por último, la primera conexión).

Realizar el servicio de mantenimiento de manera segura

Peligros del sistema hidráulico

Asegúrese de seguir las indicaciones del fabricante para liberar la presión de fluidos antes de realizar algún servicio de mantenimiento. El sistema hidráulico está presurizado siempre que el motor está encendido y puede retener presión incluso después de que se apague el motor. Complete el ciclo de los controles hidráulicos, incluido el control hidráulico auxiliar, si hubiera, después de apagar el motor.

Verifique que no haya fugas e inspeccione las mangueras



- Durante la inspección del sistema hidráulico:
- Espere a que el fluido se enfríe antes de desconectar las líneas. El fluido hidráulico caliente puede provocar quemaduras graves.
 - Utilice una protección adecuada para los ojos. El fluido hidráulico puede provocar lesiones permanentes en los ojos.
 - Al ventilar o llenar el sistema hidráulico, atíjelo lentamente la tapa del recipiente de llenado y quítela gradualmente. **Nunca** configure una válvula de alivio del sistema hidráulico a una presión superior a la que recomienda el fabricante.

Peligro del diesel ultra bajo en azufre (ULSD)

¡ADVERTENCIA! El diesel ultra bajo en azufre (ULSD)

posee un mayor peligro de ignición estática que las formulaciones anteriores de diesel con un mayor contenido de azufre. Evite la muerte o las lesiones provocadas por incendios o explosiones. **Consulte a su proveedor de combustible o del sistema de suministro para asegurarse de que el sistema de suministro cumpla con las normas de carga de combustible para las prácticas adecuadas de puesta a tierra y enlace.**

Peligros del refrigerante del motor

¡ADVERTENCIA! Evite las lesiones graves o la muerte. Los sistemas de enfriamiento líquidos acumulan presión a medida que el motor se calienta; por lo tanto, **actúe con precaución antes de retirar la tapa del radiador.**

- Detenga el motor y espere a que se enfríe el sistema.
- Use ropa de protección y anteojos de seguridad.
- Gire lentamente la tapa del radiador hasta el primer tope para dejar liberar presión antes de retirar la tapa por completo.



Deje que el radiador se enfríe antes de retirar lentamente la tapa

Peligro de penetración de fluidos presurizados

¡ADVERTENCIA! La penetración accidental de fluido presurizado en las manos o el cuerpo es peligrosa y podrá derivar en la muerte de una persona o la aparición de lesiones graves. Entre los fluidos presurizados se encuentran el aceite, el fluido hidráulico, el agua o el combustible. **Actúe con precaución al revisar las fugas de fluido ya que los fluidos presurizados pueden penetrar en la piel o los ojos y provocar lesiones personales graves.**

Si se detecta una fuga:

- Asegúrese de que el motor esté apagado; libere la presión en el sistema de fluidos.
- Utilice una protección adecuada para las manos y los ojos. Examine visualmente las líneas de fluido en las inmediaciones de la fuga para detectar roturas o rajaduras. **No** utilice las manos para verificar la presencia de fugas. Repare o reemplace las líneas de fluidos de acuerdo con las recomendaciones del fabricante.



El fluido presurizado puede penetrar en el cuerpo.

Realizar el servicio de mantenimiento de manera segura

Peligros del sistema eléctrico

Lámparas e iluminación

Las lesiones por penetración de fluidos no siempre son evidentes. Las víctimas informaron que estas lesiones son como la picadura de una abeja o una espina debajo de la piel. Si sospecha que ha sufrido una lesión por penetración de fluidos, no corra riesgos. Busque de inmediato la atención médica correspondiente. Si le penetra algún fluido en la piel, un médico familiarizado con este tipo de lesiones deberá extraerlo quirúrgicamente al cabo de algunas horas.

Algunas máquinas vienen equipadas con lámparas xenón de alta intensidad de descarga (HID, por sus siglas en inglés) que operan a voltajes muy altos. No comience la instalación de las lámparas xenón de HID, salvo que las lámparas y el motor estén apagados, se haya retirado la llave, si hubiera, y lleve una protección adecuada para los ojos.

¡ADVERTENCIA! No mire directamente una lámpara xenón de HID. Se podría producir un daño a los ojos.

Use guantes y anteojos de seguridad cuando manipule las lámparas. Es posible que ocurran chispas eléctricas peligrosas, las que pueden producir lesiones o dañar el conector. Consulte las advertencias del fabricante que vienen con las lámparas de reemplazo.

Realizar el servicio de mantenimiento de manera segura

Prácticas comunes para un mantenimiento seguro

Tenga una ventilación adecuada.

Si debe encender un motor en un área cerrada, saque los humos del escape del área con una extensión del tubo de escape.

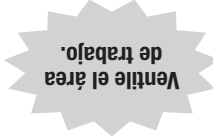

Ventile el área de trabajo.



ADVERTENCIA! Los humos del escape contienen monóxido de carbono, que puede ser mortal si se inhala. **Nunca opere ningún tipo de motor sin una ventilación adecuada.** LOS HUMOS DEL ESCAPE PUEDEN CAUSAR LA MUERTE.

Coloque una etiqueta de advertencia que diga "NO OPERAR" a las palancas de control.
Bloquee/coloque una etiqueta de no operar de acuerdo con el manual de operación del fabricante. Si hubiera una llave, retírela y llévela con usted.

Instale dispositivos de soporte aprobados al trabajar cerca o debajo de equipos elevados.

ADVERTENCIA! Las máquinas u otros equipos sin apoyo o elevados pueden caerse sorpresivamente. **Nunca se coloquen debajo de un equipo elevado a menos que esté apoyado sobre dispositivos de soporte aprobados.** La caída de equipos puede producir la muerte de una persona o la aparición de lesiones graves por aplastamiento.

Retire solo las protecciones o las cubiertas que brinden acceso al área donde se realizará el mantenimiento. Vuelva a colocar todas las protecciones y las cubiertas cuando haya finalizado el trabajo.

ADVERTENCIA! Evite las lesiones o la muerte. **Nunca trabaje en una máquina con el motor en funcionamiento, salvo que así se indique en los manuales del fabricante para servicios de mantenimiento específicos.**

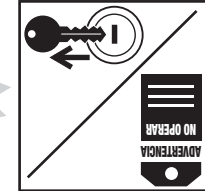

Utilice una etiqueta que diga "NO OPERAR".

Realizar el servicio de mantenimiento de manera segura

Peligros del combustible

ADVERTENCIA! Evite las lesiones graves o la muerte. **Siempre use recipientes para combustible o equipos dispensadores de combustible aprobados para reducir el riesgo de explosión o incendio.** Siempre respete estas prácticas para reducir la posibilidad de que ocurra un accidente grave:

- Apague el motor y el encendido durante una recarga de combustible.
- Apague todos los interruptores eléctricos.
- Realice la puesta a tierra la boquilla de combustible con el cuello de llenado.
- Mantenga las chispas y las llamas abiertas alejadas del combustible. No fume mientras recarga combustible o cuando manipula los recipientes de combustible.
- No corte ni suelde en las líneas, los tanques o los recipientes de combustible ni cerca de ellos.
- No desborde el tanque ni derrame combustible. Limpie de inmediato el combustible derramado.



Prohibido fumar y prohibidas las llamas abiertas



Evite el aplastamiento, utilice un apoyo adecuado para los equipos elevados



ADVERTENCIA! Evite las lesiones por aplastamiento. **Nunca use bloques de concreto como soporte.** Podrían derrumbarse, incluso sosteniendo cargas livianas, y provocar lesiones graves o la muerte de una persona. Si debe trabajar debajo de un equipo elevado, siempre use grúas, gatos u otros apoyos rígidos y estables diseñados y aprobados para la carga en cuestión. Al usar gatos o grúas asegúrese de que estén bien apoyadas. Asegúrese de que las grúas o los gatos estén en buenas condiciones. Nunca use gatos con piezas rajadas, torcidos o dobladas. Nunca use cables pelados o deformados.

Utilice gatos y grúas con cuidado.

Las plataformas o los bloques de seguridad deben colocarse en una parte rígida de la máquina. No coloque las plataformas debajo de ejes o ruedas que puedan rotar.

Realizar el servicio de mantenimiento de manera segura

Piezas de la segadora y su seguridad

Los fabricantes de segadoras utilizan sujetadores específicos y piezas diseñadas especialmente para cumplir con los requisitos de las operaciones de corte. Las piezas críticas como pernos de cuchilla autobloqueantes, cuchillas, pasadores, carcassas y otros elementos especiales tienen requisitos específicos de resistencia, diseño y ajuste para la segadora de la marca y el modelo que está utilizando. Evite posibles lesiones graves o muerte por piezas no aprobadas o modificaciones:

- No sustituya piezas de ferretería comunes por pernos de cuchilla u otras piezas especiales originales del fabricante.
- No sustituya cuchillas, pasadores, carcassas u otras piezas esenciales.
- No utilice pernos de mayor resistencia para reemplazar los pernos de seguridad originales del fabricante.



Evite las piezas que roten.

¡ADVERTENCIA! Evite la muerte de una persona o la aparición de lesiones graves provocadas por los atoramientos. **No use vestimenta ni accesorios holgados. Manténgase alejado de los componentes que rotan cuando el motor esté funcionando.** El contacto, el enrollamiento o el atascamiento con las piezas que rotan o se mueven podrán derivar en la muerte de una persona o la aparición de lesiones graves.

Utilice un delantal adecuado resistente a sustancias químicas y guantes resistentes a sustancias químicas para trabajar con corrosivos. Utilice guantes resistentes a los cortes y calzados de seguridad cuando manipule bloques de madera o metales con punta cortante. Siempre use anteojos de seguridad, gafas de seguridad o una máscara de protección facial. Protegen los ojos de los fluidos bajo presión, al triturar y cuando se realiza el mantenimiento a las baterías. También se debe proteger contra los escombros, los líquidos y el material suelto que desprendan la máquina, las herramientas y el aire/agua presurizados.

Use una máscara de protección facial y siga las indicaciones del fabricante cuando desarme componentes con resorte o cuando trabaje con ácidos de la batería. Mantenga los bolsillos libres de todo tipo de objeto que pueda caerse y entrar en la máquina.

Manipule con cuidado las herramientas y las piezas pesadas para protegerse a usted y a terceros. Baje los artículos, no los arroje.

Prepare el área de trabajo.

- Coloque la máquina en un área nivelada, que no entorpezca el paso de otros equipos de trabajo.
- Asegúrese de que la luz, la ventilación y el espacio sean adecuados.
- Retire el aceite, la grasa o el agua para eliminar las superficies resbaladizas.
- Limpie alrededor del área donde se realizará el mantenimiento para reducir la contaminación.

Preparar la máquina

Se deben controlar o reducir al mínimo las fuentes de energía almacenadas (eléctrica, mecánica, hidráulica, neumática, química, térmica, etc.) antes de realizar algún servicio de mantenimiento o reparación. Entre las prácticas de seguridad para evitar posibles lesiones provocadas por fuentes que liberan energía se incluyen las siguientes:

- Desconecte la PTO antes de apagar el motor.
- Coloque los controles en posición NEUTRAL o DE BLOQUEO antes de apagar el motor.
- Accione el freno de estacionamiento o bloquee las ruedas.
- Detenga todas las piezas que se muevan.
- Baje la segadora al suelo.
- Baje las alas al suelo en segadoras de ala.
- Apague el motor.

Realizar el servicio de mantenimiento de manera segura

- Siga las recomendaciones del fabricante para liberar la presión del sistema hidráulico.
- Trabaje el encendido, retire la llave (si hubiera) y llévela con usted.
- Observe y escuche si hay indicios de piezas que se muevan antes de bajar.
- Apague el interruptor eléctrico principal (si hubiera). Apoye bien o bloquee la máquina antes de trabajar debajo de ella u otros componentes elevados.
- Apoye bien o bloquee otros componentes con dispositivos de bloqueo aprobados antes de trabajar cerca o debajo de ellos.
- Libere la presión antes de desconectar o desarmar un sistema presurizado.
- Bloquee o libere la presión de los resortes antes de desarmar algún mecanismo con resorte.
- Evite la presencia de llamas, chispas o humo cerca de cualquier tipo de combustible, fluido hidráulico u otro material inflamable, por ejemplo, residuos de corte.



Evite las caídas, limpie las superficies resbaladizas.

Apagar de manera segura

Seleccione un lugar adecuado para estacionar

Al apagar la máquina, estacione en un área designada fuera del tránsito, preferentemente, a nivel del suelo cuando sea posible. Baje el equipo elevado al suelo. Si debe estacionar en una pendiente o inclinación, coloque la máquina en ángulos rectos con respecto a la pendiente, accione el freno de estacionamiento y bloquee las ruedas.

¡ADVERTENCIA! Evite la muerte de una persona o la aparición de lesiones graves provocadas por los movimientos accidentales de la máquina. **Nunca deje una máquina sin supervisión con el motor encendido.**

Apagado seguro

El procedimiento de apagado detallado se encuentra en los manuales del fabricante. En general, esto incluye lo siguiente:

- Detenga la máquina.
- Asegúrese de que todas las ruedas estén sobre el suelo.
- Coloque los controles en posición neutral o de bloqueo.
- Accionar el freno de mano.
- Desactivar el motor durante un breve periodo para que se enfríe.
- Desconecte el embrague de la PTO y la transmisión.
- Baje la segadora al suelo.
- Baje las alas de las segadoras de ala al suelo.
- Detenga el motor y retire la llave de encendido, si hubiera.
- Complete el ciclo de todos los controles hidráulicos para eliminar la presión.
- Eleve el asiento/barras) de sujeción del operador, si hubiera.

Realizar el servicio de mantenimiento de manera segura

Sepa lo que está haciendo.

El mantenimiento de este tipo de máquina no debe realizarse por personal sin experiencia o capacitación. Es peligroso, salvo que se realice correctamente. Asegúrese de contar con las habilidades, la información, las herramientas correctas y el equipo adecuado para realizar el trabajo de manera segura.

Asegúrese de realizar el mantenimiento del equipo de acuerdo con las indicaciones del fabricante. Revise con regularidad el funcionamiento de los dispositivos de protección y seguridad. **No** realice ningún tipo de trabajo en una máquina salvo que esté autorizado y calificado para hacerlo.

Si está autorizado para realizar el mantenimiento, **lea los manuales de operación, de mantenimiento y de servicio del fabricante.** Analice las indicaciones: revise las tablas de

lubricación, examine todos los mensajes con indicaciones que haya en la máquina.

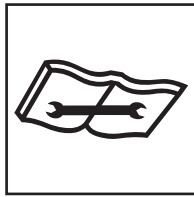

Realice el mantenimiento del equipo.



Use todo lo que necesite para protegerse. No corra riesgos.

- Casco
- Calzado de seguridad
- Anteojos de seguridad, gafas de seguridad o máscara de protección facial
- Guantes para tareas pesadas
- Protección auditiva
- Vestimenta reflectante
- Indumentaria para clima húmedo
- Respirador o máscara con filtro

Es posible que necesite lo siguiente:

Use toda la vestimenta de personal adecuada y el EPP que se le entregue o que se requiera dadas las condiciones laborales.

Protéjase

Apague el motor, retire la llave.

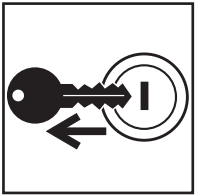

- Sáquese el cinturón de seguridad/la sujeción.
- Trabé las cubiertas y los cerramientos, si hubiera.
- Apague el interruptor eléctrico principal, si hubiera.
- Cuando deje la máquina, espere que todas las piezas móviles se detengan antes de bajarse. Siempre mantenga un contacto de tres puntos con los pedales y las manijas. Mire hacia la máquina al bajar. Nunca salte de la máquina.
- Bloquee las ruedas si está en una pendiente o inclinación.

Operar de manera segura

Prácticas de seguridad para el corte en orillas de zanjas

- Tenga cuidado al cortar en orillas de zanjas. Esté atento a derrumbes, áreas erosionadas y obstrucciones de corte a lo largo de las orillas de las zanjas. Golpear obstáculos con segadoras laterales o de brazo puede hacer que el extremo delantero del tractor se desvíe hacia la zanja.
- Las operaciones de corte en orillas de zanjas con alas y brazos elevados pueden reducir la efectividad de la carcasa contra objetos arrojados para la protección del operador de la segadora.
- Utilice cabinas ROPS cerradas, recintos de protección especiales y otras carcasas para el operador disponibles del fabricante al realizar estas operaciones.
- Inspeccione el área de corte y retire o señale todos los objetos extraños y escombros que deben evitarse con la segadora.



Evite golpear obstrucciones.

Prácticas de seguridad para segadoras de alas y montadas en el lateral

- Las posiciones elevadas de las alas reducen la protección de la carcasa y aumentan los riesgos de peligro por objetos arrojados y contacto con las cuchillas.
- Evite posibles lesiones graves o la muerte por objetos arrojados o contacto con las cuchillas al levantar y bajar las alas durante las operaciones de corte:
- No corte con transmisiones dentro de 300 pies (92 m) de una segadora rotativa o dentro de 100 pies (31 m) de una segadora de disco.
- Asegúrese de que nadie está cerca de la segadora mientras levanta o baja las alas.
- Apague la PTO y espere que todos los elementos en rotación se detengan antes de levantar la plataforma de la segadora o la sección del ala.
- Solo levante el ala para despejar objetos en la trayectoria de corte o para adaptarse a la pendiente del terreno.
- Baje el ala elevada al suelo después de despejar el objeto o las condiciones del terreno.
- Detenga el corte si alguien se acerca más de la distancia de seguridad para el tipo de segadora.

Prácticas de seguridad para el corte en terrenos irregulares

- La estabilidad del tractor y la segadora se reduce en pendientes y terrenos irregulares.
- Como en todas las condiciones de corte, utilice tractores equipados con ROPS y cinturón de seguridad. **Asegúrese de que el sistema TOPS/ROPS esté elevado y asegurado en su lugar y siempre utilice el cinturón de seguridad.**
- Evite los vuelcos del tractor y la segadora, y mantenga el control de la estabilidad del equipo:
- Revise los manuales del operador del tractor y la segadora para conocer las prácticas de operación seguras en pendientes y condiciones de terreno irregulares. Explique las prácticas a aquellos usuarios y operadores que no pueden leer.
- Evite operar en pendientes sumamente empinadas. Tome precauciones para mantener el control sobre el equipo cuando opera en estas condiciones.
- Aumente la estabilidad del tractor agregando contrapesos en las ruedas, lastre y aumentando el espacio entre las ruedas al máximo. Consulte el manual del operador para obtener recomendaciones.
- Mantenga una velocidad de corte mínima.
- Realice giros graduales y amplios.
- Evite arranques, paradas y giros bruscos cuando opere hacia arriba, abajo o a través de pendientes.

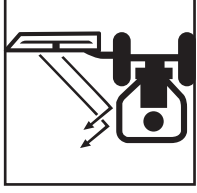

Utilice cabinas ROPS cerradas o recintos de protección

- No levante las segadoras montadas en la parte trasera o lateral, ni las alas desde el suelo durante estas operaciones.
 - Manténgase alerta ante hoyos, protuberancias, surcos, rocas, tocónes u otras obstrucciones que podrían volcar la máquina.
 - Evite las condiciones con suelo resbaladizo que podrían provocar la pérdida del control y volcar el tractor y la segadora.
 - Evite golpear y tocar el suelo cruzando en diagonal zanjas y desniveles pronunciados.
- Tome precauciones para mantener la estabilidad del equipo durante operaciones de corte en terrenos irregulares y pendientes. Usted es el juez final en cuanto a cualquier pendiente que pueda ser negociada de manera segura.

Operar de manera segura

Observar los espacios libres del equipo

El enganche de tres puntos y las segadoras montadas en el lateral tienen un arco de giro más grande que las segadoras de enganche de tracción. Permita que haya suficiente espacio libre para que la segadora se mueva al girar.

No permita que haya transeúntes cerca del tractor y la segadora cuando se mueven o transportan.

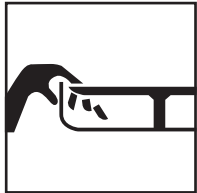

Detenga la cuchilla antes de desatascarla.

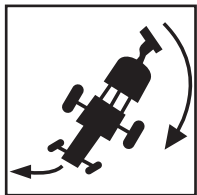

Proporcione un espacio adecuado para que la segadora gire.

Corte de hierba extremadamente alta

Es posible que necesite cortar dos veces la hierba extremadamente alta y no cultivada. (Consulte la página 32, **Objetos arrojados por la segadora**).

Primera pasada de corte:

- Apague la segadora y el tractor utilizando la práctica adecuada de apagado del equipo antes de bajarse el tractor. (Consulte la página 38, **Apagado seguro**).
- Inspecciones el área y retire o señale escombros u obstáculos.
- Corte la hierba más alta (10 a 15 pulgadas/ 250 a 400 mm) para evitar objetos ocultos.

Segunda pasada de corte:

- Apague la segadora y el tractor utilizando la práctica adecuada de apagado del equipo antes de bajarse el tractor.

- Inspecciones el área y retire o señale escombros u obstáculos.
- Corte la hierba a la altura deseada y, cuando sea posible, en un ángulo de 90 grados con respecto a la primera pasada de corte.

Prácticas de seguridad para segadoras montadas en la parte inferior

- Cuando corte con una segadora montada en la parte inferior:
- Mantenga las tolvas de descarga extraíbles en su lugar y sobre la abertura de descarga.
 - Nunca se sitúe sobre la carcasa de una segadora cuando el motor del tractor esté en funcionamiento.
 - Distribuya los recortes de hierba con la tolva de descarga orientada hacia el área cortada.
 - Antes de desatascar la segadora o la tolva de descarga, apague la máquina siguiendo la práctica adecuada de apagado del equipo. (Consulte la página 38, **Apagado seguro**).

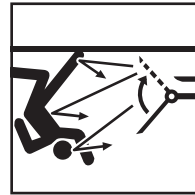

Mantenga la tolva en su lugar.

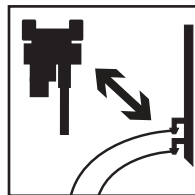

No se acerque a las líneas eléctricas con energía.

Riesgos y peligros de obstrucciones en la parte superior de alas o brazos

Revise la presencia de obstrucciones en la parte superior con las segadoras de ala o brazo elevados para evitar lesiones graves o la muerte por entrar en contacto con lo siguiente:

- Líneas eléctricas y aparatos eléctricos.
- Ramas bajas de árboles.
- Otras obstrucciones en la parte superior.
- Mantenga la distancia especificada de las líneas eléctricas y los aparatos. Nunca se acerque a las líneas eléctricas o aparatos energizados con ninguna parte de la máquina, salvo que se hayan tomado todas las precauciones de seguridad que se requieran a nivel local, estatal/provincial y federal (OSHA). Actúe con precaución.

¡PELIGRO! Evite electrocución o lesiones graves por contacto o falta de espacio libre adecuado con líneas eléctricas o aparatos energizados. No permita que la máquina o el accesorio se acerque o entre en contacto con ninguna línea eléctrica. No se acerque ni toque ninguna máquina en contacto con una línea eléctrica.

Operar de manera segura

Objetos arrojados por la segadora

Dependiendo del propósito diseñado, las segadoras están diseñadas para cortar hierba, maleza, arbustos y cultivos. Las cuchillas de la segadora han sido diseñadas y probadas para un uso resistente. Sin embargo, estas no están destinadas a entrar en contacto con objetos sólidos como rocas, cemento o metal. Dicho impacto puede provocar que se despidan objetos. Los transeúntes nunca deberían estar dentro de 300 pies (92 m) de una segadora rotativa en funcionamiento o de 100 pies (31 m) de una segadora de disco en funcionamiento. Detenga la operación si alguien se encuentra dentro de la distancia de seguridad para el tipo de segadora.

La carcasa de la segadora está diseñada para reducir el riesgo de arrojar objetos y se debe mantener correctamente y en su lugar durante las operaciones de corte.

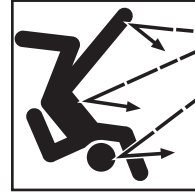

Tenga cuidado con los objetos despididos.

Operar de manera segura

Velocidad de corte de la segadora

La velocidad de corte adecuada depende de las condiciones del terreno y de la altura de la hierba que se cortará:

- Siga las velocidades de funcionamiento recomendadas por el fabricante.
- Utilice una velocidad de corte más lenta para cortar hierba alta y densa.
- Utilice una velocidad de corte más rápida para cortar hierba de altura media, menos densa y en condiciones de terreno llano.
- Utilice una velocidad de corte más lenta para cortar en terrenos irregulares, inclinados o desconocidos.

Las segadoras de disco están diseñadas para utilizar velocidades de corte más rápidas al operar en campos libres de escombros y peligros en la superficie.

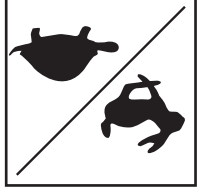

Utilice la velocidad de corte adecuada

No corte mientras se desplaza hacia atrás. Es más probable que se arrojen objetos y pueden llegar más lejos. Apague la PTO, espere que las cuchillas dejen de girar, eleve la segadora y luego retroceda. Corte desplazándose hacia adelante.

Cortar marcha atrás

Segadoras de disco: Cuando utilice una segadora de disco es importante que conozca el área que se cortará. Si el operador ha cortado el campo antes y conoce todos los obstáculos que se pueden presentar, es suficiente observar hacia adelante el camino de la segadora para ver si hay objetos adicionales que puedan haber ingresado al campo. Este listo para detenerse o evitar cualquier objeto que podría ser peligroso si es arrojado por la segadora. Si planea cortar un campo desconocido y está cerca de un camino transitado o podría haber personas dentro de los 100 pies (31 m) de la segadora, debe inspeccionar y limpiar o señalar el campo.

Operar de manera segura

Segadoras montadas en minicargadores

- Consulte los manuales del operador de la segadora y el minicargador del fabricante.
- Baje los brazos de elevación e incline hacia adelante el acoplador de la cargadora.
- Conduzca la cargadora lentamente hacia adelante hasta que el borde superior del acoplador esté completamente debajo del reborde superior del marco de montaje del accesorio de la segadora.
- Incline el acoplador hacia atrás hasta que el accesorio esté levemente levantado del suelo. Esto provocará que el marco de montaje del accesorio de la segadora se ajuste contra la parte frontal del acoplador.
- Conecte los pasadores o cuñas del acoplador. Asegúrese de que los pasadores o cuñas del acoplador estén completamente conectados y trabados en la segadora.
- Conecte las mangueras hidráulicas de la segadora a la cargadora.

Segadoras montadas con enganches de tracción:

- Consulte los manuales del operador de la segadora y el tractor del fabricante.
- Retire el acoplador rápido del enganche de tres puntos, si lo hubiere.
- Ajuste la longitud de la barra de tracción del tractor para operación de la PTO a 540 o 1000 rpm.
- Cuando retroceda el tractor hacia la segadora, NUNCA deje que nadie se coloque entre el tractor y la segadora.
- Conecte solo al enganche de la barra de tracción.
- Asegure correctamente la cadena de remolque de seguridad de la segadora al tractor.
- Conecte de manera segura la línea de transmisión a la PTO del tractor. Tire y empuje de la línea de transmisión para asegurarse de que esté bloqueada en la PTO.
- Baje la carcasa principal en su lugar.
- Conecte las mangueras hidráulicas de la segadora al tractor.
- Asegúrese de que las alas o plataformas elevadas de la segadora estén soportadas por los cilindros antes de retirar las trabas de transporte. Nunca utilice la fuerza para liberar las trabas de transporte o de las alas. Las alas o plataformas podrían caer y aplastarlo.



Compruebe que las alas estén apoyadas antes de liberar las trabas.

Realizar el arranque adecuado

Corte solo durante el día o en buenas condiciones de iluminación artificial.

Evite las lesiones graves o la muerte debido a objetos arrojados por la segadora o el contacto con cuchillas:

- Mantenga en su lugar y en buen estado las carcasas de cadena, las carcasas deflectoras flexibles o sólidas, o las tolvas de descarga.
- Mantenga alejados a los transeúntes como mínimo a 300 pies (92 m) de la segadora rotativa o a 100 pies (31 m) de la segadora de disco durante la siega.
- Nunca dirija la descarga de la segadora hacia una persona. Mantenga alejadas manos, pies y otras partes del cuerpo de las piezas rotativas, cuchillas y aberturas de descarga.
- No opere la segadora en posición de transporte.
- No se acerque a una segadora hasta que todos los movimientos se hayan detenido.

Acoplamiento de la transmisión de la PTO de la segadora:

- Eleve la segadora a la altura de corte máxima.
- Conecte la PTO a bajas rpm del motor.
- Aumente las rpm del motor a la velocidad de rpm de la PTO especificada para la segadora.
- Baje la segadora a la altura de corte deseada.
- Deténgase y apáguela inmediatamente si la segadora golpea un obstáculo.
- Inspeccione y repare cualquier daño en la segadora antes de continuar con el corte.
- No opere la segadora si presenta vibraciones fuertes o ruidos inusuales.



No opere una segadora dañada.

Evite doblar las cuchillas: Ayude a prevenir que las cuchillas de la segadora se doblen o rompan evitando el contacto con objetos sólidos. Las cuchillas de la segadora están diseñadas para cortar hierba, arbustos, vegetación boscosa y árboles pequeños y ramas. No están destinadas a estar en contacto con objetos sólidos como rocas, cemento o postes de acero. Inspeccione el área antes de cortar. Retire o señale claramente cualquier objeto sólido y corte alrededor.

Reemplace las cuchillas dañadas: Inspeccione las cuchillas de la segadora diariamente o después de golpear un objeto sólido. Si una cuchilla de la segadora se daña (se dobla, raja o rompe) o se desgasta más del 25 por ciento del tamaño original, se debe retirar y reemplazar por una nueva. Siempre utilice las cuchillas originales del fabricante. Las cuchillas de marcas no originales pueden no cumplir con los requisitos del fabricante de resistencia, dureza y ductilidad.

Operar de manera segura

Consejos de seguridad para el transporte

Siempre use el cinturón de seguridad al subir o bajar la máquina de un dispositivo de traslado, por ejemplo, un camión de plataforma.

Al trasladar una máquina, siga los procedimientos para subir, amarrar y bajar que recomienda el fabricante.

Varias precauciones se aplican a todas las máquinas:

- Mantenga alejados a los transeúntes.
- Suba y baje en una superficie nivelada.
- Mantenga una visibilidad adecuada; para ello, suba o baje en áreas bien iluminadas y lejos de otros vehículos, equipos o construcciones.
- Bloquee el vehículo de traslado para que no pueda moverse.
- Asegúrese de que la plataforma y las rampas del remolque estén en buenas condiciones.
- Utilice rampas con el tamaño y la resistencia correspondientes, con un ángulo bajo y una altura adecuada.
- La parte posterior del remolque debe estar bloqueada o sostenida.
- Mantenga la plataforma y las rampas del remolque libres de arcilla, aceite, hielo, nieve y otros materiales que puedan resbalar.
- Retroceda la máquina hacia arriba de la rampa sobre el vehículo de traslado. Si la máquina cuenta con un accesorio pesado, podría ser necesario conducir hacia adelante sobre el vehículo de traslado.

Operar de manera segura

Sistema de toma de fuerza (PTO)

Asegúrese de operar el tractor a la velocidad de rpm de la PTO especificada para la segadora.

- Cuando se opera un tractor con un sistema de PTO impulsado por transmisión, una segadora rotativa tendrá un efecto volante significativo y puede continuar impulsando el tractor. Este tipo de tractor debería estar equipado y operado como se indica a continuación:
- Instale una línea de transmisión equipada con un embrague de rueda libre.
- Proporciónese suficiente espacio y tiempo para maniobrar anticipando los giros, las paradas y las reducciones de velocidad.

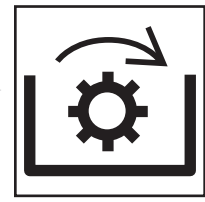

Utilice la velocidad de la PTO adecuada

Enganchar la segadora al tractor

Segadoras con enganches de tres puntos:

- Consulte los manuales del operador de la segadora y el tractor del fabricante.
- Coloque la palanca selectora del elevador hidráulico (eje oscilante) del tractor en posición descendente para evitar movimientos inesperados.
- Es posible que se necesiten contrapesos delanteros para mantener el control de la dirección y la estabilidad delantera. Consulte los manuales del operador del fabricante.
- Cuando retroceda el tractor hacia la segadora, NUNCA deje que nadie se coloque entre el tractor y la segadora.
- Conecte la segadora a los enganches de tres puntos del tractor y asegure el pasador en su posición.
- Conecte de manera segura la línea de transmisión a la PTO del tractor.
- Tire y empuje de la línea de transmisión para asegurarse de que esté bloqueada en el eje de la PTO.
- Baje la carcasa principal en su lugar si es móvil.

Operar de manera segura

Consejos de seguridad para el transporte

Siempre use el cinturón de seguridad al subir o bajar la máquina de un dispositivo de traslado, por ejemplo, un camión de plataforma.

Al trasladar una máquina, siga los procedimientos para subir, amarrar y bajar que recomienda el fabricante.

Varias precauciones se aplican a todas las máquinas:

- Mantenga alejados a los transeúntes.
- Suba y baje en una superficie nivelada.
- Mantenga una visibilidad adecuada; para ello, suba o baje en áreas bien iluminadas y lejos de otros vehículos, equipos o construcciones.
- Bloquee el vehículo de traslado para que no pueda moverse.
- Asegúrese de que la plataforma y las rampas del remolque estén en buenas condiciones.
- Utilice rampas con el tamaño y la resistencia correspondientes, con un ángulo bajo y una altura adecuada.
- La parte posterior del remolque debe estar bloqueada o sostenida.
- Mantenga la plataforma y las rampas del remolque libres de arcilla, aceite, hielo, nieve y otros materiales que puedan resbalar.
- Retroceda la máquina hacia arriba de la rampa sobre el vehículo de traslado. Si la máquina cuenta con un accesorio pesado, podría ser necesario conducir hacia adelante sobre el vehículo de traslado.

Operar de manera segura

Encadene y bloquee la segadora de manera segura para el traslado

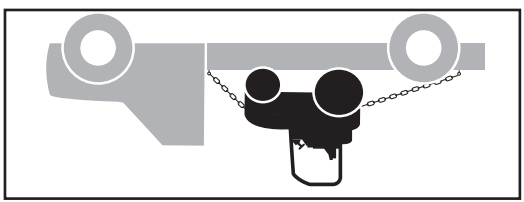

- Cubra o retire el cartel de VML que está en la parte posterior de la máquina, si hubiera, para evitar confundir a los conductores que siguen el vehículo de traslado.
- Encadene y bloquee la máquina de manera segura para el traslado. Utilice puntos de amarre, según indica el fabricante en la máquina. Siga las indicaciones de amarre del fabricante que figuran en el manual del operador.
- Baje la máquina desplazándola en la dirección opuesta, no gire la máquina.

Operar de manera segura

Desplazamiento en el área de trabajo

Desplácese despacio y con calma en áreas congestionadas. Vale la pena ser gentil en estos casos. Deje pasar primero a las máquinas con carga. Mantenga una distancia segura con otras máquinas. Circule con precaución. No obstruya su visión al desplazarse o trabajar. (Consulte la página 24, **Áreas con visibilidad obstruida**).

Desplazar la máquina de manera segura

Al desplazarse sobre terreno desnivelado, **REDUZCA LA MARCHA** para evitar perder el control. Evite las pendientes empinadas o las superficies inestables. En ningún caso se desplace de un lado a otro sobre pendientes excesivamente empinadas. Antes de operar en pendientes, verifique las condiciones de la superficie para asegurar una tracción adecuada. La pérdida de tracción podría hacer que la máquina se resbale y vuelque.

ADVERTENCIA! Evite las lesiones graves o la muerte de una persona. **Desplácese hacia arriba y abajo de las pendientes con el extremo pesado de la máquina apuntando cuesta arriba.**

ADVERTENCIA! Evite las lesiones graves o la muerte de una persona. **Asegúrese de poder ver hacia dónde está yendo.**

Tenga cuidado con las condiciones laborales peligrosas

Esté atento a los peligros. Sepa dónde está en todo momento. Tenga cuidado con las ramas, los cables o las puertas. Se requiere precaución al trabajar en las partes superiores de terrapienes o pendientes. Siempre opere la máquina en forma perpendicular al terraplen. Manténgase alejado del borde.

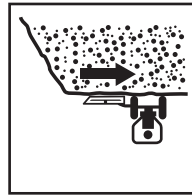

Opere de manera perpendicular a los terrapienes; manténgase alejado de los bordes.

Actúe con precaución al trabajar en pistas, terrapienes y pendientes. Manténgase alejado de los bordes de las cuestas. Al trabajar cerca de condiciones peligrosas, procure que haya un observador para detectar la presencia de peligros. Asegúrese de que permanezcan a una distancia segura de su máquina.

ADVERTENCIA! Nunca opere la máquina cerca del borde de una saliente o un barranco. Los bordes podrían derrumbarse o podría producirse un desprendimiento y derivar en la muerte de una persona o la aparición de lesiones graves.

Reglas en caminos

Si la máquina se debe conducir o transportar sobre la carretera, consulte el manual del fabricante para obtener instrucciones.

Consulte las regulaciones locales para conocer las señalizaciones, luces, luces intermitentes, etc. requeridas al desplazarse por caminos públicos. Se requiere iluminación en las segadoras que obstruyen las luces traseras del tractor u otras luces de advertencia.

Al desplazarse en calles o caminos públicos, obedezca todas las reglamentaciones de tránsito que se aplican a su máquina. Asegúrese de que las luces y los letreros de advertencia estén en su lugar y visibles. Asegúrese de que haya un emblema de vehículo de movimiento lento (VML) y la Señal de Identificación de Velocidad (SIS, por sus siglas en inglés), si corresponde, colocados y de que sean visible para cualquier vehículo que se acerque desde atrás.

Avigüe si tiene que usar un vehículo escolta.

Acérquese a las intersecciones con precaución; observe los letreros de control de velocidad y tránsito. Evite las frenadas de pánico y los giros abruptos.

Como cualquier operador responsable, sea considerado detrás de usted, es una buena idea hacerse a un lado periódicamente y permitir que el tránsito pase cuando es seguro hacerlo.

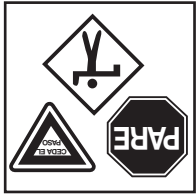

Obedezca las normas de tránsito

Mantenga su máquina bajo control. Antes de ingresar a pasos a desnivel, túneles o pasos subterráneos, verifique el tránsito que se aproxima o si hay obstrucciones.

Tener cuidado con los obstáculos

Deténgase en todos los cruces de ferrocarril y mire a ambos lados antes de proceder. Nunca estacione en áreas con tránsito. Si es necesario detenerse de noche, salga del camino y coloque las balizas o los reflectores. Al conducir de noche, utilice las luces adecuadas.

Ajuste su velocidad a las condiciones. Evite viajar sobre obstáculos, como troncos, tocónes de árboles o terreno accidentado siempre que sea posible.

Operar de manera segura

Recordar estas normas

Permanezca en el asiento del operador con el cinturón de seguridad ajustado cuando opere. Asegúrese de que tiene visibilidad adecuada y suficiente iluminación durante la operación. Tenga el control de la máquina en todo momento.

Recordar a las otras personas

Nunca permita que una persona sin capacitación o no calificada opere la máquina. Si se opera inadecuadamente, esta máquina podría provocar la muerte o lesiones graves. **ADVERTENCIA!** En la segadora agrícola/industrial solo entra una persona. Evite la muerte de una persona o la aparición de lesiones graves; **no permita nunca que haya acompañantes!** **ADVERTENCIA!** Manténgase alejado de todos los componentes en rotación. El enrollamiento o el atascamiento podría provocar lesiones graves o la muerte.

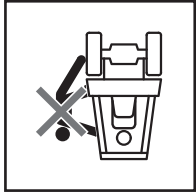

No permita el traslado de pasajeros.

Áreas con visibilidad obstruida

Las máquinas tienen áreas donde la visibilidad del área de trabajo del operador puede verse afectada por la máquina en sí. Los postes del sistema ROPS, los accesorios e, incluso, los artículos de la cabina podrían limitar la visión del área circundante y, posiblemente, impedir la visualización de peligros o de las personas que estén alrededor. Estas áreas con visibilidad obstruida varían de una máquina a otra. Es muy importante que esté al tanto de estas áreas antes de operar la máquina.

Siga estas precauciones de seguridad para reducir los peligros que plantean las áreas con visibilidad obstruida:

- Preste particular atención al elevar o bajar la segadora o el accesorio porque pueden cambiar las áreas con visibilidad obstruida.
- Mire alrededor de la máquina antes de operar. Los objetos que están cerca de la máquina y del piso pueden ser difíciles de observar desde la estación del operador.
- Siempre mire en la dirección que se desplazará, incluida la marcha atrás. La alarma de retroceso no reemplaza la obligación de mirar hacia atrás cuando opera la máquina en reversa.
- Mantenga alejados a los transeúntes, incluso cuando la máquina posea una alarma de retroceso.

Seguir las prácticas de operación segura

Incluya estas prácticas seguras en su rutina:

- Mantenga ajustado el cinturón de seguridad (si hubiera). Opere suavemente los controles; no sacuda las palancas de dirección ni los mandos de control.
- Evite las detenciones, los arranques o los giros repentinos. Actúe con cuidado y aplique un criterio sensato.
- Nunca intente operar los controles salvo que esté correctamente sentado en la estación del operador.

ADVERTENCIA! Evite las lesiones graves o la muerte de una persona. **Cuando utilice la máquina, mantenga todo el cuerpo dentro de la cabina del operador.** Nunca trabaje con la cabeza, los brazos, los pies o las piernas fuera de la estación del operador.

Retroceder de manera segura

Asegúrese de que todas las personas estén a salvo, **al menos a 300 pies (92 m) de la segadora rotativa o a 100 pies (31 m) de la segadora de disco**, y opere de acuerdo con las leyes provinciales/estatales, locales, federales o las recomendaciones del fabricante que aplican a este equipo y su uso. Es importante que conozca y cumpla con todas las reglas específicas del lugar de trabajo o del empleador. El conocimiento de su parte puede evitar accidentes.

Verifique que la alarma de retroceso (si hubiera) esté funcionando correctamente. Recuerde: **la alarma de retroceso no reemplaza la obligación de mirar hacia atrás cuando opera en reversa.** Siempre mire alrededor antes de retroceder la máquina. Asegúrese de que todas las personas estén a salvo. Conduzca hacia adelante siempre que sea posible. **SIEMPRE MIRE EN LA DIRECCIÓN QUE SE DESPLAZARÁ.**

Arrancar de manera segura

Arranque del motor

!ADVERTENCIA! Arranque el motor solo desde el asiento del operador. **Nunca intente arrancar el motor puenteadando las terminales o llegando a la llave desde el exterior de la estación del operador.** La máquina podría moverse inesperadamente, lo que podría provocar lesiones graves o la muerte de las personas que se encuentren en su camino.

Conozca el procedimiento de arranque exacto de su máquina. Consulte los manuales de operación del fabricante para obtener información sobre el arranque.

- Ubíquese en el asiento del operador y ajústelo para que pueda operar adecuadamente todos los controles.
- Ajustese el cinturón de seguridad, si cuenta con él.
- Siempre mantenga las puertas de la cabina cerradas y las ventanas y pantallas de la estructura de protección del operador (OPS) en su lugar.
- Familiarícese con los dispositivos de advertencia, los medidores y los controles operativos.
- Asegúrese de que los controles estén en la posición neutral o de bloqueo.
- Verifique el desenganche de la PTO.

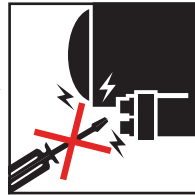

Nunca arranque el motor puenteadando las terminales

Arrancar de manera segura

Los fluidos de éter/arranque en frío son ALTAMENTE

INFLAMABLES. Antes de usarlos, siempre lea las indicaciones del recipiente del fluido de éter/arranque en frío y los manuales de operación del fabricante.

!ADVERTENCIA! Evite las lesiones provocadas por las explosiones o los incendios. Si el motor tiene una bujía de precalentamiento u otro tipo de colector de admisión de precalentamiento, siga las indicaciones del fabricante antes de usar el fluido de éter/arranque en frío.

Después de arrancar el motor

Mire los medidores, los instrumentos y las luces de advertencia para asegurarse de que estén funcionando y de que sus lecturas se encuentren dentro de los valores operativos.

Realizar una revisión de operación

No utilice una máquina que no esté en buenas condiciones de operación. Es su responsabilidad verificar el estado de todos los sistemas y de realizar la revisión en un área segura.

Probar los controles

Las segadoras agrícolas/industriales vienen equipadas con diversas configuraciones de control, patrones y modos de operación; cada una con sus características propias o configurables para ajustarse a las preferencias personales o a las aplicaciones específicas.



Opere los instrumentos y controles de manera correcta.

!ADVERTENCIA! Antes de operar la máquina por motivos laborales, **asegúrese de poder controlar la velocidad y la dirección de la máquina.** La pérdida de control podrá derivar en la muerte de una persona o la aparición de lesiones graves.

- Con las palancas o los mandos de control en posición neutral, pruebe el control de velocidad del motor.
- Opere cada pedal, palanca o mando de control para cerciorarse de que todas las funciones sean correctas.
- Opere las palancas o los mandos de control de desplazamiento para asegurar la operación correcta hacia adelante y en reversa. Desplazándose lentamente en un área despejada y segura, pruebe la dirección hacia la derecha e izquierda.
- Revise los frenos de estacionamiento y de servicio de acuerdo con los manuales de operación del fabricante.

Asegúrese de que la máquina esté funcionando correctamente; para ello, realice lo siguiente:
Asegúrese de saber el patrón de control que seleccionó y de comprender cómo funcionará la máquina con ese patrón de control.

!ADVERTENCIA! Un puenteadado inadecuado puede provocar lesiones graves o la muerte de una persona si se produce una explosión de la batería o si la máquina comienza a andar. **Siempre siga los procedimientos adecuados de puenteadado.** (Consulte la página 46, Peligros de la batería).

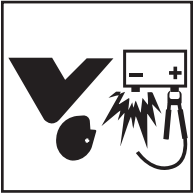

!ADVERTENCIA! Si tiene problemas para arrancar el motor y debe utilizar los cables para puentear, siga las indicaciones de los manuales de operación del fabricante. **Se necesitan dos personas para un puenteadado.** En un puenteadado, el operador deberá colocarse en el asiento del operador para que la máquina esté bajo control cuando arranque el motor.

Auxiliares de arranque

!ADVERTENCIA! Los humos del escape pueden causar la muerte. **No respire los humos del escape!**

- Procure que no quede ninguna persona en el área.
- Haga sonar la bocina.
- Arranque el motor siguiendo las indicaciones en los manuales de operación del fabricante.
- Si se tuviera que encender el motor u operar la máquina en un área cerrada, asegúrese de que haya una ventilación adecuada.

Prepararse para una operación segura

Conozca el área de trabajo

Obtenga la mayor cantidad de información posible sobre su área de trabajo.

Controle el nivel del suelo o piso

Antes de operar, inspeccione la superficie por la que se desplazará. Busque hoyos, áreas resbaladizas, desniveles y obstáculos como rocas, troncos u otros elementos. Fíjese que no haya lugares irregulares ni obstáculos escondidos en las superficies que puedan provocar un accidente o la pérdida de control. Fíjese que no haya derrames de aceite, lugares mojados y superficies resbaladizas. Verifique la ubicación de arroyos y barrancas. Fíjese que no haya suelo blando, barro profundo, agua estancada ni zonas pantanosas. Fíjese que no haya nada que pueda hacerle perder el control o hacer que la máquina se dé vuelta.

Plantifique anticipadamente el recorrido, así puede ver y proteger a los transeúntes. Recoja los escombros que puedan perforar los neumáticos.

Plantifique su trabajo.

Corrija las condiciones inseguras. No opere en área problemáticas donde no se pueden retirar o señalizar escombros y obstáculos.

Verifique los espacios aéreos.

- El procedimiento de corte más eficiente.
- La altura del material a cortar.
- Condiciones del terreno de operación.
- Cómo utilizar de la mejor manera el patrón de corte hacia adelante.
- La posibilidad de transeúntes o personas cercanas de quedar expuestos a objetos despididos.

Verifique el espacio de las puertas, los toldos y aéreo. Sepa exactamente el espacio que tiene debajo de los cables aéreos de electricidad y teléfono.

⚠ PELIGRO! Tocar o estar próximo a una máquina que está en contacto con una fuente eléctrica con corriente o cerca de esta podrá derivar en la muerte de una persona o en la aparición de lesiones graves. **Nunca se acerque a las líneas eléctricas con ninguna parte de la máquina ni con la carga, salvo que se hayan tomado todas las precauciones de seguridad que se requieran a nivel local, estatal/provincial y federal (OSHA).** Se requiere precaución porque las fuentes con alto voltaje pueden generar un arco sin contacto.

Al trabajar cerca de las líneas de energía, deberá suponer que todas las líneas están con corriente.

Prepararse para una operación segura

Subir y bajar correctamente

Siempre utilice un contacto de tres puntos al subir o bajar de la máquina. Un contacto de tres puntos significa una mano y dos pies o dos manos y un pie en contacto con la máquina en todo momento.

Nunca suba ni baje mientras lleve herramientas u objetos que le impidan tener un contacto de tres puntos. Apoye las piezas o las herramientas. Manteniendo un contacto adecuado, suba o baje y, luego, recoja el objeto.

Mire hacia la máquina cuando se suba o baje de ella. Limpíese el calzado y las manos. Retire los residuos químicos, la nieve, el hielo, el barro o el aceite de los peldaños y los pasamanos.

Al subir y bajar:

- Utilice los pasamanos y las placas de los peldaños.
- Nunca utilice volantes, mandos de control ni controles como pasamanos.
- Nunca salte para subir o bajar de la máquina.
- Nunca suba ni baje de una máquina en movimiento.

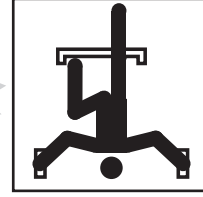

Utilice un contacto de tres puntos al subir o bajar.

Avisar al personal antes de comenzar

Antes de comenzar, camine alrededor de toda el área de la máquina. **Asegúrese de que no haya ninguna persona debajo de la máquina, en ella o próxima a ella.** Aviseles a las personas que va a usar la máquina y no la use hasta que todos se alejen de ella. Como operador del equipo, usted es responsable del uso seguro de la máquina; por lo tanto, asegúrese siempre de haber comunicado sus planes de trabajo al resto de las personas que estén en el lugar.

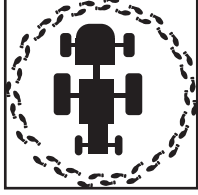

Antes de comenzar, camine alrededor de toda el área de la segadora.

Prepararse para una operación segura

Peligro de combustible diesel ultra bajo en azufre (ULSD)

Evite el riesgo de electricidad estática al cargar combustible.

¡ADVERTENCIA! El diesel ultra bajo en azufre (ULSD, por sus siglas en inglés) posee un mayor peligro de ignición estática que las formulaciones anteriores de diesel. Evite la muerte o las lesiones graves provocadas por incendios o explosiones. **Consulte a su proveedor de combustible o del sistema de combustible para asegurarse de que el sistema de suministro cumple con las normas de carga de combustible para las prácticas adecuadas de puesta a tierra y enlace.**

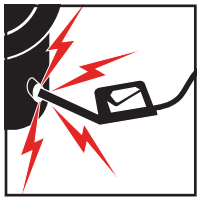

La descarga estática durante la carga de combustible puede provocar una explosión.



Prohibido fumar y prohibidas las llamas abiertas

Limpieza

Limpie ventanas, luces y letreros de seguridad. Asegúrese de que el área del operador, las palancas de dirección, los pedales, los mandos de control, los pedales y las manijas estén limpios. La presencia de aceite, grasa, hierba, hojas, agujas, nieve, hielo, barro o escombros en estas áreas podría hacer que se resbale y caiga, o bien que pierda el control de la máquina. Limpie el exceso de barro de las botas antes de ingresar en la máquina. Retire todos los objetos personales u otros artículos del área del operador. Coloque estos objetos en una caja de herramientas o retirarlos de la máquina.

Actúe con precaución al cargar combustible.

¡ADVERTENCIA! Evite las lesiones provocadas por incendios o explosiones. **Nunca llene el tanque de combustible con el motor encendido, mientras fuma o cerca de una llama abierta.**

Nunca desborde el tanque ni derrame combustible. Si se derrama combustible, límpielo de inmediato. Asegúrese de usar el tipo y el grado correctos de combustible.

Realice la puesta a tierra del embudo o de la boquilla de combustible con el cuello de llenado para evitar las chispas que puedan generar vapores de combustible. Asegúrese de volver a colocar la tapa del depósito de combustible, si hubiera, cuando termine.

Prepararse para una operación segura

Los humos del escape en un espacio cerrado pueden causar la muerte

Ventile el escape y asegure un flujo de aire fresco si se utiliza un motor de combustión interna en un espacio cerrado. **¡ADVERTENCIA!** Los humos del escape de motores diesel, con gasolina o gas licuado de petróleo pueden causar la muerte. **No respire los humos del escape de ningún tipo de motor.**



Ventile el área de trabajo.

Operar en ambientes inflamables/explosivos

¡ADVERTENCIA! Una máquina estándar equipada con un supresor de chispas/silenciador de detención de chispas no se puede operar en ambientes inflamables o explosivos. El uso en ambientes inflamables o explosivos puede provocar incendios o explosiones que podrían derivar en lesiones graves o la muerte.

Use solo una segadora agrícola/industrial aprobada con una designación de G, GS, D, DS, DY, LP, LPS, G/LP o GS/LPS en la etiqueta. Consulte el Código de Reglamentaciones Federales (OSHA) 29 CFR Parte 1910.178 para determinar las áreas en las que se pueden operar estas máquinas.



No opere en ambientes inflamables/explosivos

Prepararse para una operación segura

Evitar lesiones provocadas por equipos elevados

Evite cualquier posible lesión por aplastamiento por caída de la segadora u otro equipo elevado.

Antes de trabajar cerca o debajo de la segadora o piezas del equipo elevadas:

- Apoye o bloquee de manera segura la segadora o las piezas del equipo elevadas de acuerdo con el manual del operador.
- Apoye, bloquee o trabde de manera segura las alas con dispositivos de bloqueo aprobados o baje la segadora o las piezas del equipo al suelo.
- Utilice las trabas de transporte cuando traslade la segadora en caminos públicos.

ADVERTENCIA! Prevenga posibles lesiones por aplastamiento por caídas de equipos. La falla del sistema hidráulico o de una pieza podría generar que los equipos sin apoyo se caigan. **No pase debajo de equipos elevados a menos que estén apoyados correctamente de acuerdo con el manual del operador.**

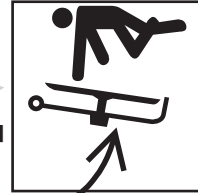

Evite el aplastamiento: bloquee o apoye de manera segura la segadora.

Prepararse para una operación segura

Verifique el sistema de enfriamiento

Cuando verifique el sistema de enfriamiento, siga las instrucciones del fabricante para asegurarse de que el motor esté apagado y frío para evitar que el ventilador arranque inesperadamente. Asegúrese de que los enfriadores y el compartimiento del motor estén limpios y libres de escombros, ya que podrían encenderse y provocar un incendio. Si la máquina se enfría con aire, asegúrese de que no esté obstruido el flujo de aire de la unidad de enfriamiento. Si se enfría con líquidos, revise el nivel del refrigerante (en el tanque de desbordamiento, si se proporciona).

ADVERTENCIA! Deje que el radiador se enfríe antes de controlar el nivel. Los fluidos calientes del radiador pueden escaparse como vapor y quemarle. (Consulte la página 44, Peligros del refrigerante del motor.)

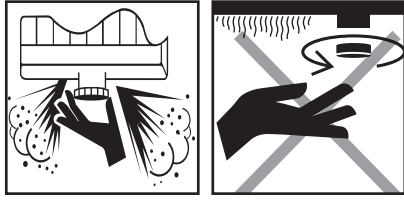

Deje que el radiador se enfríe antes de retirar lentamente la tapa

Utilice una protección adecuada para las manos y los ojos



Las lesiones por penetración de fluidos no siempre son evidentes. Las víctimas informaron que estas lesiones son como la picadura de una abeja o una espina debajo de la piel. Si sospecha que ha sufrido una lesión por penetración de fluidos, no corra riesgos. Busque de inmediato la atención médica correspondiente. Asegúrese de que el profesional médico comprenda que la lesión puede haber sido causada por una inyección de fluidos. Si le penetra algún fluido en la piel, un médico familiarizado con este tipo de lesiones deberá extraerlo quirúrgicamente al cabo de algunas horas.

Peligro de penetración de fluidos presurizados

ADVERTENCIA! La penetración accidental de fluido presurizado en las manos o el cuerpo es peligrosa y podrá derivar en la muerte de una persona o la aparición de lesiones graves. Entre los fluidos presurizados se encuentran el aceite, el fluido hidráulico o el agua. **Actúe con precaución al revisar las fugas de fluido ya que los fluidos presurizados pueden penetrar en la piel o los ojos y provocar lesiones personales graves.**



El fluido presurizado puede penetrar en el cuerpo.

- Asegúrese de que el motor esté apagado; libere la presión en el sistema de fluidos.
- Utilice una protección adecuada para las manos y los ojos.
- Examine visualmente las líneas de fluido en las inmediaciones de la fuga para detectar roturas o rajaduras.
- No utilice las manos para verificar la presencia de fugas.
- Repare o reemplace las líneas de fluido, de acuerdo con la recomendación del fabricante.

Prepararse para una operación segura

Inspeccione las máquinas

Antes de comenzar su jornada laboral, controle lo siguiente según corresponda y repare o reemplace lo necesario. A lo largo de este manual se proporcionan detalles y descripciones adicionales. Realice los procedimientos de mantenimiento diarios y periódicos, de acuerdo con las indicaciones del fabricante.



Verifique todos los dispositivos de seguridad

Condición de la máquina

Asegúrese de que todos los componentes estén en condiciones de operación. Verifique lo siguiente según corresponda:

- La ROPS está presente y, si es plegable, está elevada y en posición segura.
- La cabina está en buenas condiciones, y las ventanas y puertas funcionan correctamente.
- La carcasa principal de la toma de fuerza (PTO, por sus siglas en inglés) está instalada y funciona correctamente.
- La plataforma de la estación del operador está despejada de herramientas, objetos y escombros.
- Los escalones, asideros o barandillas asociados están limpios y funcionales.

Prepararse para una operación segura

Compatibilidad de la máquina

- Los acopladores no tienen fugas.
 - Los dispositivos de iluminación, como luces intermitentes de advertencia, señales de giro, luces traseras, luces de freno y luces de trabajo están conectadas y funcionan correctamente.
- Las especificaciones del tractor, minicargador o hileradora deben ser suficientes para operar la segadora en todos los modos de operación y transporte. Consulte los manuales del operador o comuníquese con el distribuidor para conocer las especificaciones. Verifique las siguientes especificaciones según corresponda:
- Tamaño del eje de la PTO y número de estrías
 - Dirección de rotación del eje de la PTO
 - Accesorios mecánicos, como el enganche de 3 puntos, barra de tracción u otras características de acoplamiento/bloqueo
 - Rendimiento y conexión del sistema eléctrico o hidráulico

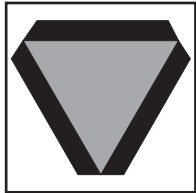

Utilice iluminación y señalización

- El cinturón de seguridad, los anclajes y la hebilla están en condiciones de funcionamiento adecuadas.
- Los yugos, acopladores y carcasas de la línea de transmisión de la PTO de la segadora están en buenas condiciones de funcionamiento.
- Elementos de corte y accesorios de sujeción no están desgastados, dañados ni en falta. Nunca intente reparar piezas desgastadas o dañadas; siempre reemplácelas con piezas originales OEM.
- El sistema de protección contra objetos despedido está completa e instalada.
- Los dispositivos de iluminación y señalización, como luces intermitentes de advertencia, señales de giro, luces de freno, luces de trabajo, emblemas de vehículo de movimiento lento (VML), señales de identificación de velocidad (SIS, por sus siglas en inglés), si corresponde, y materiales reflectantes son visibles y están en condiciones de funcionamiento.

Accesorios de la máquina

- Mantenga la superficie de la plataforma del operador limpia y libre de grasa, aceite, suciedad, nieve o hielo. Los escalones y asideros deben estar limpios y ser funcionales.
- Todas las demás protecciones y carcasas están correctamente instaladas y en buenas condiciones.
- Los componentes del sistema hidráulico están asegurados de manera correcta y no están dañados ni tienen fugas.
- Las ruedas y los neumáticos no están dañados ni le faltan piezas, los neumáticos tienen la presión correcta y las tuercas o pernos tienen la torsión adecuada.

Accesorios de la máquina

- Asegúrese de que todos los accesorios estén en condiciones de operación. Verifique los siguientes accesorios según corresponda:
- Los sistemas de fijación mecánica están conectados correctamente.
- Pasador de enganche de la barra de tracción con retención positiva.
- Cadena de remoique de seguridad.
- Enganche de 3 puntos u otras características de acoplamiento/bloqueo.
- Las mangueras hidráulicas están conectadas y funcionando correctamente.
- Las mangueras hidráulicas están correctamente apoyadas para evitar daños.
- Las funciones hidráulicas funcionan según lo esperado.

Seguir un programa de seguridad

Conocer el equipo

Lea y comprenda las etiquetas de seguridad de PELIGRO, ADVERTENCIA, PRECAUCIÓN y AVISO, y demás letreros informativos que aparezcan en la máquina, los accesorios y los manuales de operación del fabricante. Fídale a su supervisor o al distribuidor que le expliquen la información que no comprenda. El incumplimiento de las indicaciones de seguridad podrá derivar en la muerte de una persona o la aparición de lesiones graves.

Conozca lo siguiente sobre el equipo:

- Función, propósito y uso de todos los controles
- Velocidades correctas de operación
- Características de frenado y dirección
- Capacidades para andar sobre terrenos con pendientes
- Radio y espacio para girar
- Cómo detener rápidamente el equipo ante una emergencia

Tenga en cuenta que la lluvia, la nieve, el hielo, las piedras sueltas, el suelo blando, las pendientes y otras condiciones del lugar pueden afectar las capacidades de operación de la máquina. Asegúrese de estar absolutamente familiarizado con la estabilidad, los frenos, la tracción y demás características de manejo de la máquina en todas las condiciones que es probable que se le presenten.

Prepararse para una operación segura

Verifique y use todos los dispositivos de seguridad que estén disponibles.

Con el fin de protegerlos a usted y a otras personas, es posible que su máquina incluya los equipos de seguridad que se indican a continuación. Es posible que se requiera un equipo adicional o que algunos artículos no se necesitan, según los accesorios que se utilicen, las condiciones del área de trabajo o las normas pertinentes del área de trabajo. Verifique que cada artículo que se requiera esté debidamente colocado y en condiciones de operación:

- Cinturón de seguridad.
 - Estructura de protección contra vuelcos (ROPS, por sus siglas en inglés).
 - Luces de operación y advertencia.
 - Letreros de seguridad
 - Protecciones
 - Espejos
 - Kit de primeros auxilios
 - Extintor/sistema de extinción de incendios
 - Limpiaaparabrisas/desempañador
- ¡Uselos! Nunca retire ni desconecte ningún dispositivo de seguridad.



Lea y comprenda los manuales antes de operar una máquina



Conozca la capacidad y las características de la máquina

IMPORTANTE: En este manual se cubren las prácticas seguras del equipo de segadoras agrícolas/industriales. Si su máquina está equipada con otros dispositivos o accesorios especiales, lea los manuales de operación y de seguridad del fabricante correspondientes a ese equipo en cuestión antes de usarlo.

Asegúrese de que todas las estructuras de protección, protecciones, carcasas, pantallas y paneles del fabricante estén en buenas condiciones, en su lugar y bien sujetos. Los componentes de seguridad dañados, faltantes o flojos pueden provocar una situación peligrosa para usted como operador. Nunca retire ni modifique ningún componente de seguridad, incluida la carcasa contra objetos despididos de una segadora.



Ajustese el cinturón de seguridad.



Nunca modifique una ROPS

Sepa que dispositivos se requieren por motivos de protección durante una operación en particular y úselos.

¡ADVERTENCIA! Nunca retire ni modifique una ROPS, salvo cuando se realice el mantenimiento de la máquina. Vuelva a instalarla correctamente antes de la puesta en marcha de la máquina. Esto puede derivar en la muerte de una persona o la aparición de lesiones graves.

Seguir un programa de seguridad

Conozca las normas

La mayoría de las áreas de trabajo tienen normas que rigen el uso y el mantenimiento de los equipos. Antes de empezar a trabajar en un lugar nuevo, consulte al supervisor o coordinador de seguridad. Pregunte sobre las normas que deberá obedecer.

La OSHA hace cumplir las leyes federales dentro del territorio de los Estados Unidos que regulan la operación, la aplicación y el mantenimiento seguros de los equipos en algunas áreas de trabajo. Es responsable del empleador cumplir con estas leyes. Es posible que un representante federal inspeccione periódicamente un área de trabajo para asegurarse de que se estén siguiendo estas leyes.

Es posible que haya otras leyes locales, estatales/provinciales, federales u organizaciones internacionales que regulen el uso de este equipo, además de las normas específicas del área de trabajo o del empleador. Es importante que conozca y cumpla con todas las leyes y normas pertinentes, **incluidas aquellas que requieren la capacitación y certificación del operador.**

Estas son algunas de las normas que rigen su trabajo:

- Un tractor equipado con cinturón de seguridad y una estructura de protección contra vuelcos (ROPS) es un requisito del gobierno federal (OSHA) para la protección del operador durante las operaciones de siega. Una cabina cerrada le proporciona al operador protección adicional contra objetos despididos. Consulte los manuales del operador de su segadora para conocer si también se requiere una cabina de tractor.
- Solo las personas calificadas y autorizadas podrán operar este equipo.

Seguir un programa de seguridad

Utilice la vestimenta y el equipo de protección personal (EPP) adecuados.

- Nunca deje que los niños jueguen cerca del equipo, se suban en él o lo operen. Los niños no están calificados para operar este equipo.
- No lleve pasajeros.
- Mantenga a los transeúntes a 300 pies (92 m) de la operación de las segadoras rotativas y a 100 pies (31 m) de las segadoras de disco.

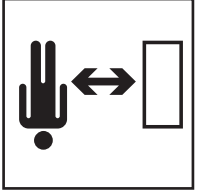

Mantenga alejados a los transeúntes.

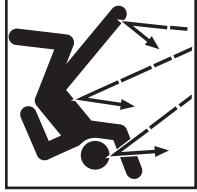

Tenga cuidado con los objetos despididos.

- Conozca el área de trabajo antes de usar el equipo. Sea consciente de los posibles peligros del terreno que pueda encontrar. Retire o señale los obstáculos y escombros que podrían dañar o ser despididos por la segadora.
- Instale correctamente todas las carcasas y protecciones antes de operar la máquina.
- Solo use accesorios y piezas aprobados por el fabricante. Siempre que abandone la máquina, baje la máquina o apague el motor y gire las palancas de control hidráulico, y retire la llave antes de dejar la estación del operador. (Consulte la página 38, **Apagado seguro.**)
- Utilice un contacto de tres puntos (pasamanos y peldaños) y mire el equipo al subir o bajar. (Consulte la página 21, **Subir y bajar correctamente.**)

Seguir un programa de seguridad

Normas de seguridad



Conozca y comprenda las normas de operación



Ajustese el cinturón de seguridad.

- Inspeccione su máquina y los accesorios antes de usarlos, de acuerdo con las indicaciones del fabricante y de su empleador. Asegúrese de que un accesorio esté correctamente instalado.
- Conozca las limitaciones y las características operativas de su equipo. No lo sobrecargue ni lo use indebidamente. Nunca modifique ni retire ninguna pieza de la máquina (salvo que usted sea personal de servicio calificado; luego, asegúrese de que se vuelva a instalar la pieza o que se reemplace si tiene fallas o se gastó).

Seguir un programa de seguridad

Para una operación segura

Para operar esta máquina de manera segura, debe estar autorizado y calificado. Debe comprender con claridad las instrucciones por escrito que brinda el fabricante, haber recibido capacitación — que incluye operar la máquina — y conocer las normas y regulaciones de seguridad del área de trabajo. Es una buena práctica de seguridad señalar y explicar los letreros y las prácticas de seguridad a terceros, y asegurarse de que estos comprendan la importancia de seguir estas indicaciones.



Nunca opere si está bajo los efectos del alcohol o las drogas

!ADVERTENCIA! Operar maquinaria mientras se está bajo los efectos del alcohol o la aparición de lesiones graves, la muerte de una persona o la aparición de lesiones graves. Las drogas y el alcohol afectan el estado de alerta, la coordinación y la capacidad del operador de operar el equipo de manera segura. **Nunca opere la máquina si está bajo los efectos del alcohol o las drogas. Nunca permita que otra persona opere la máquina si sabe que su estado de alerta o coordinación están afectados.**

Seguir un programa de seguridad

!Tenga cuidado!

Los errores humanos son el resultado de muchos factores: descuido, cansancio, sobrecarga sensorial, precapación, desconocimiento de la máquina o de los accesorios, consumo de drogas y alcohol, por nombrar algunos. Puede evitar la muerte de una persona o la aparición de lesiones graves provocadas por estas y otras prácticas laborales inseguras. Tenga cuidado; nunca dé por sentado que los accidentes no le sucederán a usted. Por su seguridad y la de terceros, actúe de manera segura y aliéntele a sus compañeros de trabajo a que también lo hagan.

Protéjase

Use toda la vestimenta personal apropiada y el equipo de protección personal (EPP) que se le entregue o que se requiera dadas las condiciones laborales. Es posible que necesite lo siguiente:

- Casco
- Calzado de seguridad
- Anteojos de seguridad, gafas de seguridad o máscara de protección facial
- Guantes para tareas pesadas
- Protección auditiva
- Vestimenta reflectante
- Indumentaria para clima húmedo
- Respirador o máscara con filtro

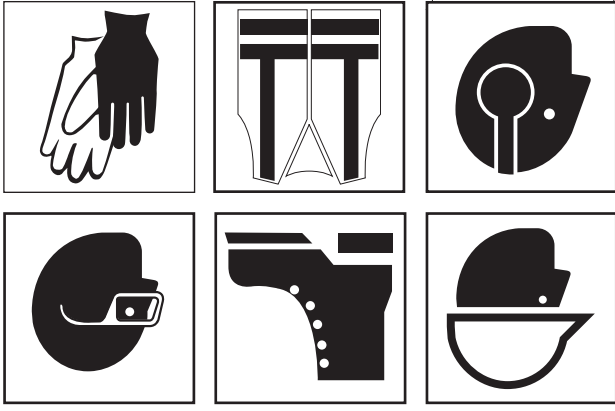

Use todo lo que necesite para protegerse, no corra riesgos. **!ADVERTENCIA!** Evite la muerte de una persona o la aparición de lesiones graves provocadas por los atoramientos. **No use vestimenta ni accesorios holgados o deshilachados que puedan quedar atrapados en las piezas que se mueven.** Entre los artículos que debe evitar se incluyen, a modo de ejemplo, puños que se caigan, corbatas y bufandas que cuelguen, carteras con cadena, joyas, pulseras y relojes de pulsera.

Tipos de segadoras agrícolas/industriales

Tipos de segadora agrícola/industrial

Las segadoras se utilizan para recortar pastizales, triturar residuos de cultivos, cortar vegetación densa y cortar cursos de agua, derechos de paso, bordes de caminos o carreteras. También, estas segadoras se utilizan para cortar hierba y otra vegetación en áreas públicas como parques y cementerios.

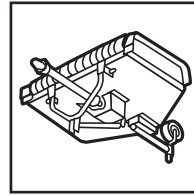

Rotativa

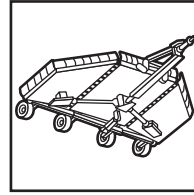

Rotativa de ala plegable

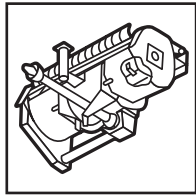

Desbrozadora

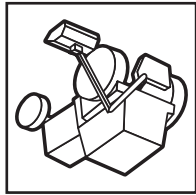

De brazo

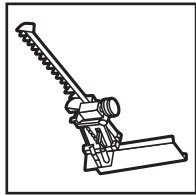

Con barra en forma de hoz

Tipos de segadoras agrícolas/industriales

Tipos de segadoras agrícolas de discos

Las segadoras de discos están diseñadas y equipadas para cortar cultivos de heno a mayor velocidad en el campo.

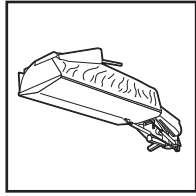

Segadora de disco

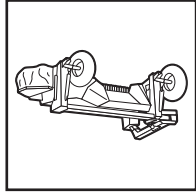

Segadora acondicionadora de disco

Las segadoras acondicionadoras de disco cortan y acondicionan los cultivos.

Las segadoras hileradoras autopropulsadas cortan y forman hileras de heno acondicionado.

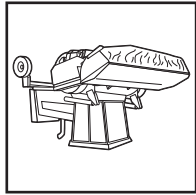

Segadora hileradora autopropulsada

Alertas de seguridad

Indicaciones de advertencia

Las indicaciones de advertencia son palabras distintas que suelen encontrarse en letreros de seguridad de la segadora y en otros equipos del área de trabajo. Estas indicaciones también pueden encontrarse en este manual y en los manuales del operador. El objetivo de estas indicaciones es alertar al operador sobre un peligro y su gravedad.

PELIGRO indica una situación peligrosa que, si no se evita, derivará en la muerte de una persona o la aparición de lesiones graves.



ADVERTENCIA indica una situación peligrosa que, si no se evita, podrá derivar en la muerte de una persona o la aparición de lesiones graves.



ATENCIÓN indica una situación peligrosa que, si no se evita, podrá derivar en una lesión menor o moderada.



AVISO Se utiliza para abordar prácticas que no están relacionadas con una lesión física.



Símbolo de Alerta de seguridad

Este símbolo de alerta de seguridad significa lo siguiente: "¡Atención! Permanezca en alerta! ¡Su seguridad está en riesgo!"



El símbolo de alerta de seguridad se utiliza para alertarlo sobre peligros potenciales e identifica mensajes de seguridad importantes en el equipo, en letreros de seguridad, en manuales o en cualquier otro lugar. Cuando vea este símbolo, manténgase alerta ante la posibilidad de muerte de una persona o aparición de lesiones personales. Lea atentamente el mensaje que sigue e infórmeles a otros operadores. Siga las indicaciones del mensaje de seguridad.

Información para el usuario/operador

Recuerde que **USTED** es la clave de la seguridad. Las buenas prácticas de seguridad no solo lo protegen a usted, sino que también protegen a las personas que le rodean. Analice este Manual y los manuales de operación del fabricante de la máquina específica. Inclúyalos en su programa de seguridad. Tenga en cuenta que este manual de seguridad está escrito únicamente para segadoras agrícolas/industriales.

Si, después de analizar los manuales de operación del fabricante y este Manual de Seguridad tiene alguna pregunta, comuníquese con el fabricante del equipo.

Ponga en práctica todas las precauciones laborales seguras habituales y recuerde lo siguiente:

- !La operación segura depende de usted!
- !Puede evitar la muerte o las lesiones graves! provocadas por las prácticas laborales inseguras!

Es **su** responsabilidad leer y comprender este Manual de Seguridad y los manuales de operación del fabricante antes de operar este equipo. En este Manual de Seguridad, se indica un paso como es una jornada laboral. Se proporcionan gráficos para ayudarle a comprender el texto. El reconocimiento de los peligros y la prevención de los accidentes dependen de su estado de alerta, atención y de la capacitación adecuada que reciba en las áreas de inspección, operación, transporte, mantenimiento y almacenamiento de este equipo.

Lea y comprenda los manuales antes de operar una máquina

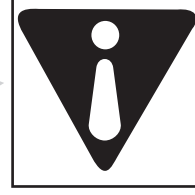

Índice

- 2 Agradecimientos
- 3 Introducción
- 4 Alertas de seguridad
- 5 Información para el usuario/operador
- 6 Tipos de segadoras agrícolas/industriales
- 8 Seguir un programa de seguridad
- 13 Prepararse para una operación segura.....
- 22 Arrancar de manera segura.....
- 24 Operar de manera segura.....
- 38 Apagar de manera segura
- 39 Realizar el servicio de mantenimiento
- 55 Palabras finales para el usuario.....

Queremos agradecerles a los miembros de la Asociación de Fabricantes de Equipos por su valiosa contribución para la elaboración de este Manual de seguridad.

AVISO DE LA PROTECCIÓN DE LOS DERECHOS DE AUTOR

Copyright, 2023, Asociación de Fabricantes de Equipos. Todos los derechos reservados. No se podrá reproducir ni difundir esta obra, ya sea en forma total o parcial, por ningún medio sin el permiso previo por escrito de la Asociación de Fabricantes de Equipos.

Copyright © 2003-2023 AEM (Asociación de Fabricantes de Equipos)
Revisado 01/03, 09/10 y 01/24

ISBN 978-1-937029-54-8

Introducción



Lea y comprenda los manuales antes de operar una máquina

¡IMPORTANTE! Antes de operar esta máquina, asegúrese de tener los manuales de operación del fabricante de esta máquina y de todos los accesorios. Si no tiene el manual de operación del fabricante, pídale una copia a su empleador, al distribuidor o, directamente, al fabricante. En todo momento, conserve en la máquina este manual de seguridad y los manuales de operación del fabricante. Lea y comprenda todos los manuales pertinentes.

Algunos fabricantes y distribuidores ofrecen videos de seguridad de la segadora agrícola/industrial de la AEM esta disponible para capacitarse y reforzar las buenas prácticas de seguridad. Este video está disponible en www.safetymaterials.org. Se alienta a los operadores a que revisen periódicamente estos recursos.

El objetivo de este Manual de Seguridad es señalar algunas de las situaciones de seguridad básicas que pueden presentarse durante la operación y el mantenimiento de su máquina e indicar las prácticas seguras para tratar estas situaciones. Este manual **NO** reemplaza los manuales de operación del fabricante.

Es posible que deban tenerse otras precauciones o que algunas indicaciones no se apliquen, según el equipo, los accesorios y las condiciones en el área de trabajo o de servicio. El fabricante no ejerce ningún tipo de control directo sobre la aplicación, la operación, la inspección o el mantenimiento del equipo. Por lo tanto, es **SU** responsabilidad aplicar buenas prácticas de seguridad en estas áreas. La información que se proporciona en este Manual complementa la información específica sobre su máquina, que se incluye en los manuales de operación del fabricante. Entre los documentos que podrían contener información que podría incidir en la operación segura de su máquina, se encuentran los siguientes:

- Letreros de seguridad
- Requisitos del seguro
- Programas de seguridad y capacitación del empleador
- Códigos de seguridad
- Leyes, normas y reglamentaciones locales, estatales/provinciales y federales

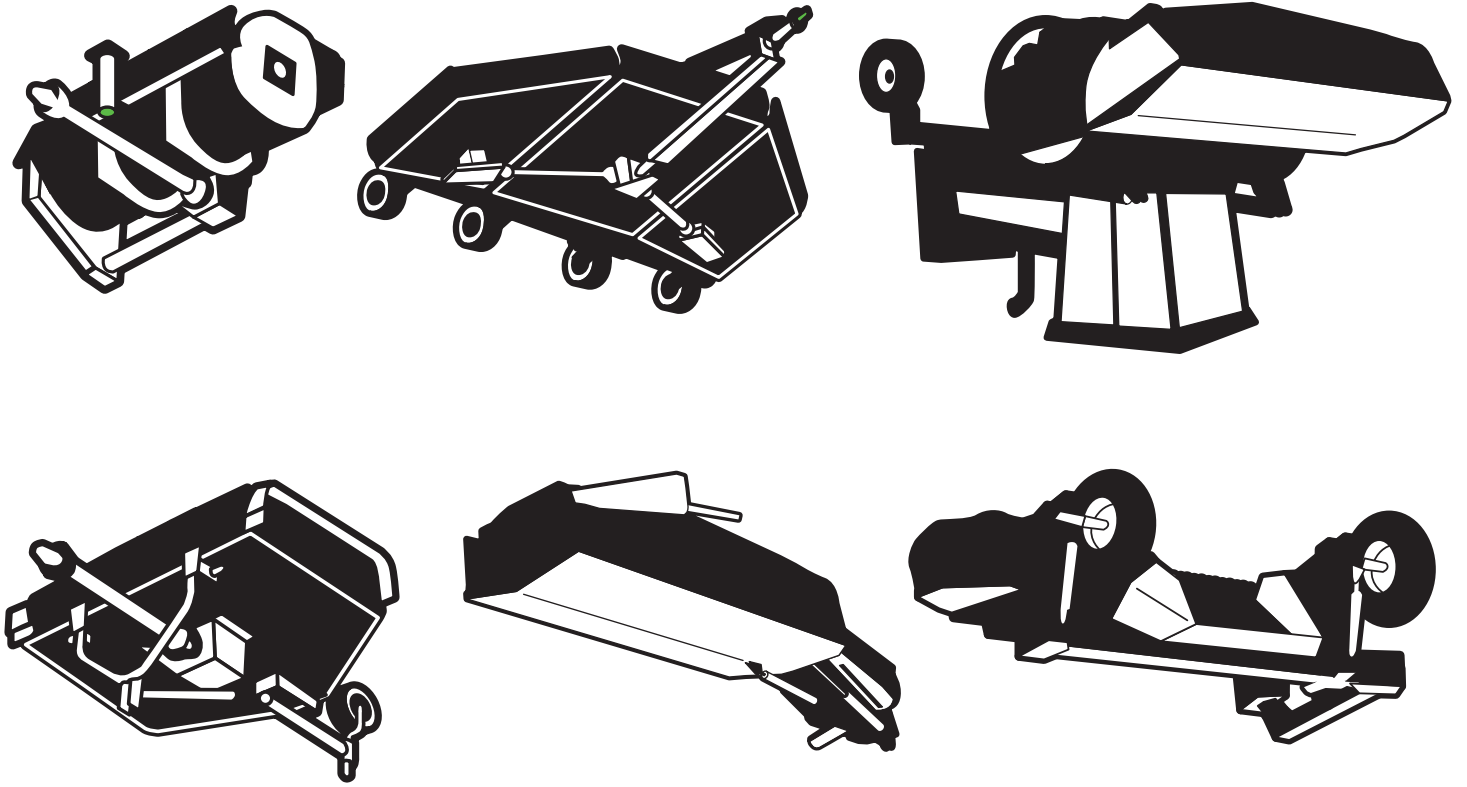

MANUAL DE SEGURIDAD



PARA EL PERSONAL DE OPERACIÓN Y MANTENIMIENTO

SEGADORA AGRÍCOLA/INDUSTRIAL

AEM
Asociación de
Fabricantes de Equipos

INTRODUCTION SECTION

Introduction Section 2-1

INTRODUCTION

This Boom Mower is designed with care and built with quality materials by skilled workers. Proper assembly, maintenance, and operating practices, as described in this manual, will help the owner/operator get years of satisfactory service from the machine.

The purpose of this manual is to familiarize and instruct. The Assembly Section instructs the owner/operator in the correct assembly of the Mower using standard and optional equipment. The Parts Listing section is designed to familiarize the owner/operator with replaceable parts on the Mower. This section provides exploded assembly drawings of each mower component illustrating each piece and the corresponding part number.

Careful use and timely service saves extensive repairs and costly downtime losses. The Operation and Maintenance Sections of the manual train the owner/operator how to work the Mower correctly and attend to appropriate maintenance. The Trouble Shooting Guide helps diagnose difficulties with mower and offers solution to the problems.

Safety is of primary importance to the owner/operator and to the manufacturer. The first section of this manual includes a list of Safety Messages, that, if followed, will help protect the operator and bystanders from injury or death. Many of the Safety Messages will be repeated throughout the manual. The owner/operator/dealer should know these Safety Messages before assembly and be aware of the hazards of operating this mower during assembly, use, and maintenance. The Safety Alert Symbol combined with a Signal Word, as seen below, is intended to warn the owner/operator of impending hazards and the degree of possible injury faced when operating this machine.



Indicates a hazardous situation that, if not avoided, WILL result in DEATH OR VERY SERIOUS INJURY.



Indicates a hazardous situation that, if not avoided, COULD result in DEATH OR SERIOUS INJURY.



Indicates a hazardous situation that, if not avoided, MAY result in MINOR OR MODERATE INJURY.

Important

Identifies special instructions or procedures that, if not strictly observed, could result in damage to, or destruction of the machine, attachments or the environment.

NOTE: *Identifies points of particular interest for more efficient and convenient operation or repair.*

INTRODUCTION

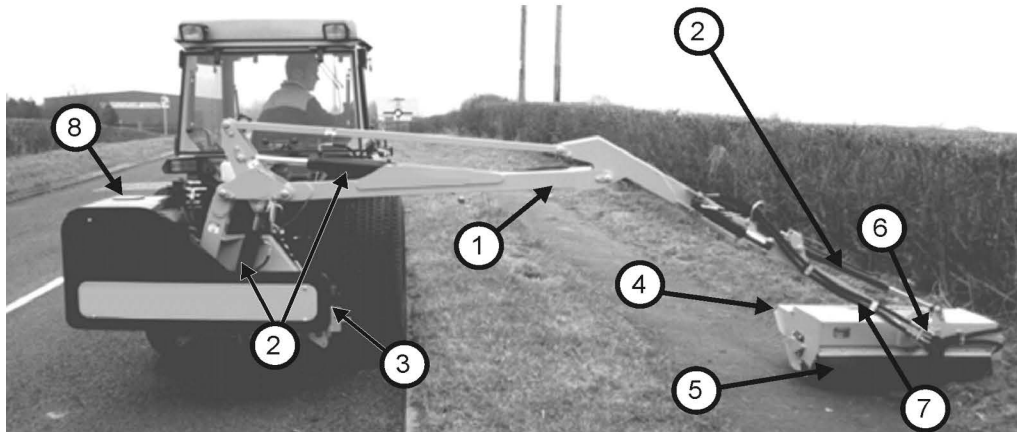

- 1 Boom Arm
- 2 Boom Arm Cylinders
- 3 Frame
- 4 Flail Head
- 5 Rubber Deflector
- 6 Motor
- 7 Hydraulic Hoses
- 8 Hydraulic Tank

INTRODUCTION

These hydraulically driven hedge cutters are designed for light-duty work. They can control grass and weeds on highways or industrial sites.

Literature Page



www.algqr.com/ble

FEATURES

- Boom Reach (with flail) 14'-1".
- Fits tractors as small as 45 PTO HP.
- Parallel arm geometry allows reach adjustment without requiring constant height adjustment.
- Totally independent hydraulics with dual rotor rotation for upward or downward cutting.
- Hydraulic break-away safety mechanism
- Simple cable controlled in-cab controls.
- "Wire Trap" system is included on each flail head to keep loose wires from rotor entanglement.
- Flail head includes adjustable front guard for protection from thrown objects.

POWER ARM ATTACHMENTS

Flail Mower

Sickle Bar Mower

DIRECTION

Throughout this Manual front and rear, left and right are determined by the normal direction of travel, the same as driving an automobile.

INTRODUCTION

ATTENTION OWNER/OPERATOR

BEFORE OPERATING THIS MACHINE:

1. Carefully read the Operator's Manual, completely understand the Safety Messages and instructions, and know how to operate correctly both the tractor and implement.
2. Fill out the Warranty Card in full. Be sure to answer all questions, including the Serial Number of the implement. Mail within 30 days of delivery date of this implement.

NOTE: Warranties are honored only if completed "Owner Registration and Warranty" forms are received by Bush Hog within thirty days of delivery of the implement.

3. Record the Model and Serial Numbers on the Warranty page at the front of the Operator's Manual. Keep this as part of the permanent maintenance file for the implement.

⚠ WARNING

TO AVOID DEATH OR SERIOUS INJURY:

- ONLY use genuine Bush Hog replacement parts, which have been validated and tested to use on Bush Hog equipment by the manufacturer.
- The equipment manufacturer cannot verify the material or structural integrity of third-party supplied non-genuine replacement parts.
- Using non-genuine parts can result in the part failing, creating hazardous conditions for operator and bystanders.

Contact local dealer or Bush Hog about repair parts at:
2501 Griffin Ave., Selma, AL 36701
Customer Service: 800-363-6096.
Email: contactus@bushhog.com www.algqr.com/bpm



⚠ WARNING
Cancer and Reproductive Harm
www.P65Warnings.ca.gov

IMPORTANT

BE AWARE BE ALERT BE ALIVE	BE TRAINED Before Operating this Mower
---	---



To prevent serious injury to yourself and/or bystanders, be trained in Safe Mowing Practices. Alamo Group Companies as well as AEM and FEMA provide training material that is critical for your Safety and the Safety of others when operating this equipment. Make these Safety Procedures an important part of every workday. Read and understand the Operator's Manual. www.algqr.com/bve

Do not let untrained individuals operate this equipment. Contact your Dealer, AEM (www.aem.org), FEMA (314-878-2304, www.FarmEquip.org), or Alamo Group (www.Alamo-Group.com) for information on training material or courses that provide training in Safer Operating Practices for Mowers.

D559

INTRODUCTION

BUSH HOG LIMITED WARRANTY



INTRODUCTION

Bush Hog warrants to the original purchaser of any new Bush Hog equipment, purchased from an authorized Bush Hog dealer, that the equipment be free from defects in material and workmanship for a period of one (1) year for non-commercial, state and municipalities' use and ninety (90) days for commercial use from date of retail sale. The obligation of Bush Hog to the purchaser under this warranty is limited to the repair or replacement of defective parts.

Replacement or repair parts installed in the equipment covered by this limited warranty are warranted for ninety (90) days from the date of purchase of such part or to the expiration of the applicable new equipment warranty period, whichever occurs later. Warranted parts shall be provided at no cost to the user at an authorized Bush Hog dealer during regular working hours. Bush Hog reserves the right to inspect any equipment or parts which are claimed to have been defective in material or workmanship.

DISCLAIMER OF IMPLIED WARRANTIES & CONSEQUENTIAL DAMAGES

Bush Hog's obligation under this limited warranty, to the extent allowed by law, is in lieu of all warranties, implied or expressed, **INCLUDING IMPLIED WARRANTIES OF MERCHANTABILITY AND FITNESS FOR A PARTICULAR PURPOSE** and any liability for incidental and consequential damages with respect to the sale or use of the items warranted. Such incidental and consequential damages shall include but not be limited to: transportation charges other than normal freight charges; cost of installation other than cost approved by Bush Hog; duty; taxes; charges for normal service or adjustment; loss of crops or any other loss of income; rental of substitute equipment, expenses due to loss, damage, detention or delay in the delivery of equipment or parts resulting from acts beyond the control of Bush Hog.

THIS LIMITED WARRANTY SHALL NOT APPLY:

4. To vendor items which carry their own warranties, such as engines, tires, and tubes.
5. If the unit has been subjected to misapplication, abuse, misuse, negligence, fire or other accident.
6. If parts not made or supplied by Bush Hog have been used in connection with the unit, if, in the sole judgment of Bush Hog such use affects its performance, stability or reliability.
7. If the unit has been altered or repaired outside of an authorized Bush Hog dealership in a manner which, in the sole judgment of Bush Hog, affects its performance, stability or reliability.
8. To normal maintenance service and normal replacement items such as gearbox lubricant, hydraulic fluid, worn blades, or to normal deterioration of such things as belts and exterior finish due to use or exposure.
9. To expendable or wear items such as teeth, chains, sprockets, belts, springs and any other items that in the company's sole judgment is a wear item.

NO EMPLOYEE OR REPRESENTATIVE OF BUSH HOG IS AUTHORIZED TO CHANGE THIS LIMITED WARRANTY IN ANY WAY OR GRANT ANY OTHER WARRANTY UNLESS SUCH CHANGE IS MADE IN WRITING AND SIGNED BY BUSH HOG'S SERVICE MANAGER, 2501 GRIFFIN AVE., SELMA, ALABAMA 36703.



Record the model number, serial number and date purchased. This information will be helpful to your dealer if parts or service are required.

MODEL NUMBER _____

SERIAL NUMBER _____

MAKE CERTAIN THE WARRANTY HAS BEEN FILED WITH BUSH HOG SELMA, ALABAMA

DATE OF RETAIL SALE _____



BUSH HOG®

ASSEMBLY SECTION

Assembly Section 3-1

ASSEMBLY

TRACTOR SELECTION

Hitch Requirement

3-Point Hitch ASABE Category I

PTO TYPE

540 RPM

PTO Shaft

Tractor must be equipped with live drive independent PTO shaft to enable forward movement to be halted while the flail head continues to operate.

Horsepower Requirement

45 PTO HP Minimum

Tractor Weight

4,410 lbs. Minimum (2,000 kg)

Check Chains/Stabilizers

Check Chains or stabilizer bars must be fitted and tightened.

Stability Requirements

20% of Total Unit Weight* to be on Front Axle

20% of Rear Axle Weight to be on LH Rear Wheel with boom and cutting head in off ground operating position.

R* Total Unit Weight is the sum of the tractor weight and the mower weight.

Recommended Minimum Outside Tire Width of 55" (1.4m)

Tractor Operator Station

Bush Hog recommends installing the RMB 1445 Boom Mower on cab tractors equipped with impact resistant glass windows. Do not operate if tractor cab is damaged.

Ballast

When attaching a boom mower to a tractor, it is extremely important to make the total unit as stable as possible. Adding Ballast or weights to the tractor may be necessary to achieve the guidelines shown below.

Front Axle: Front tractor weights may be necessary to put 20% of the total unit weight on the front axle. (Total Unit Weight is the sum of the tractor weight and the mower weight.)

Rear Axle: Wheel weights or liquid ballast should be added to the Left Hand rear tire and wheel so that a minimum of 1500lbs of the rear axle weight is on the Left Hand side when the mower boom and head are in a normal "off the ground" operating position. (For Example, the operating position for hedge cutting.)

A wide range of factors can affect the stability of the tractor and boom mower, and all should be considered before operating the unit.

Factors That Affect Stability:

- Center of gravity of the tractor and boom mower combined.
- Position of the boom and cutting head.
- Weight, wheel width, and wheelbase of the tractor.
- Acceleration, braking, turning, and the relative position of the cutting head.
- Ground conditions, including slope and softness of the ground.

ASSEMBLY

Suggestions to improve stability:

- Increase the wheel width of the rear wheels: a tractor with wider wheels is more stable.
- Ballast the Left Hand rear wheel. Liquid can be added to about 75% of the tire volume. See your tractor dealer or tire supplier for recommendations on the type of liquid.
- Addition of wheel weight to the Left Hand rear wheel.

These factors and suggestions are not all inclusive and should be used as a general guideline for tractor stability only. For additional information, and for information on your tractor's strength, see your tractor dealer or tire supplier.

DEALER SETUP INSTRUCTIONS

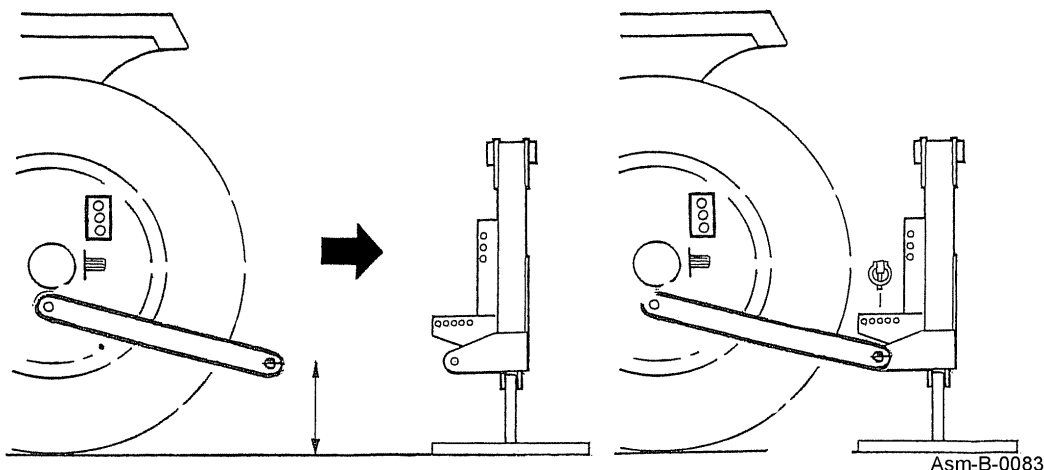

1. The machine is delivered partially assembled. To make ready for attachment to the tractor it will be necessary to select a hard level surface
2. Cut the banding straps and remove loose items and the stabilizer. Leave the transport straps on at this stage.

STABILIZER ATTACHMENT

Fit the stabilizer nose into the tractor's top link position (A). Use the highest position available, avoiding any load sensing properties. The bolt on nose of the stabilizer is reversible to accommodate a variety of tractor linkage designs.

Stretch out the stabilizer and bolt to the machine using the holes farthest from the tractor that the stabilizer will reach (B). Do not fully tighten bolts at this stage and do not replace the stabilizer nose quadrant pin. (Figure ASM-B-0085)

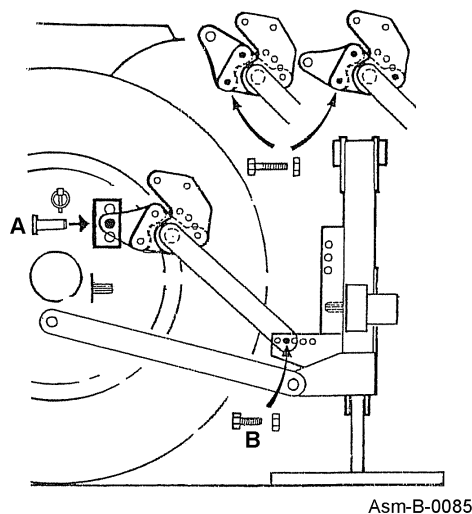

ASSEMBLY

ASSEMBLY

TOP LINK ATTACHMENT

1. Fit the machine's top link. (Figure Asm-B-0086)
2. Raise machine on tractor's linkage until the tractor PTO and the machines gearbox stub shaft are approximately in line. (Figure Asm-B-0087)

NOTE: As lift occurs be aware the machinery may tilt slightly.

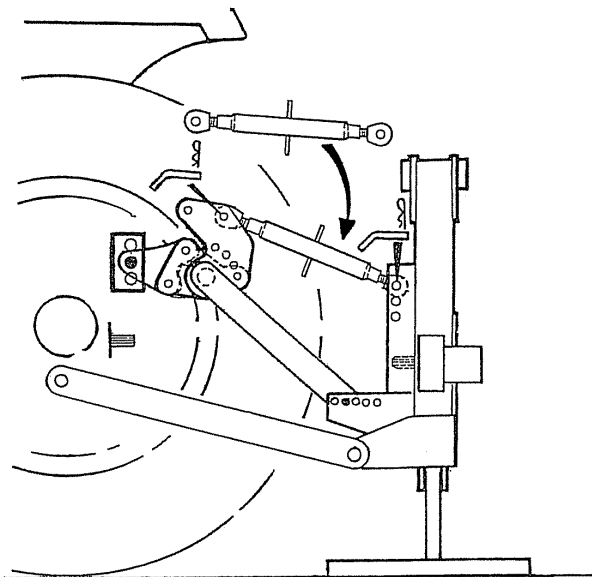

Asm-B-0086

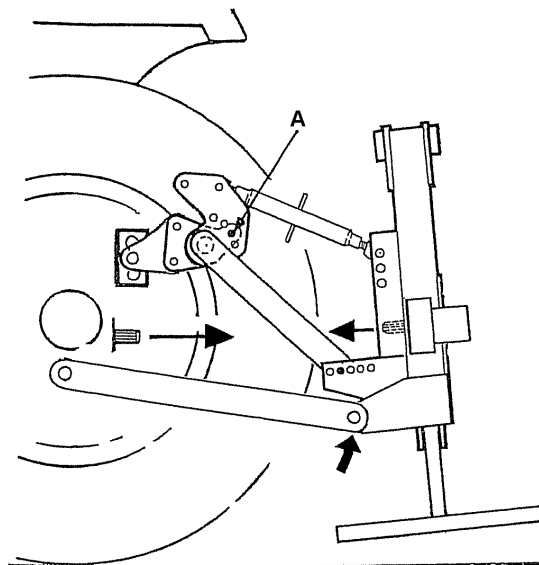

Asm-B-0087



WARNING

The quadrant lever or machine controls must be operated from the tractor seat. During this operation ensure no one is standing on or between the linkage arm or bars.

3. Adjust the top link to bring the machines frame vertical. (Figure Asm-B-0088)
4. Refit the top link nose quadrant pin, fine adjust position using the tractor's draft lift.(A) (Figure Asm-B-0089)
5. Lower tractor linkage control so that machines weight is taken by the yoke.
6. Fully tighten the stabilizer lower bolts (C).

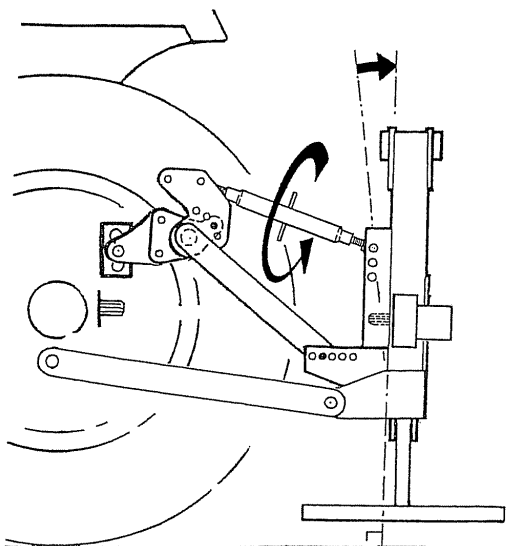

Asm-B-0088

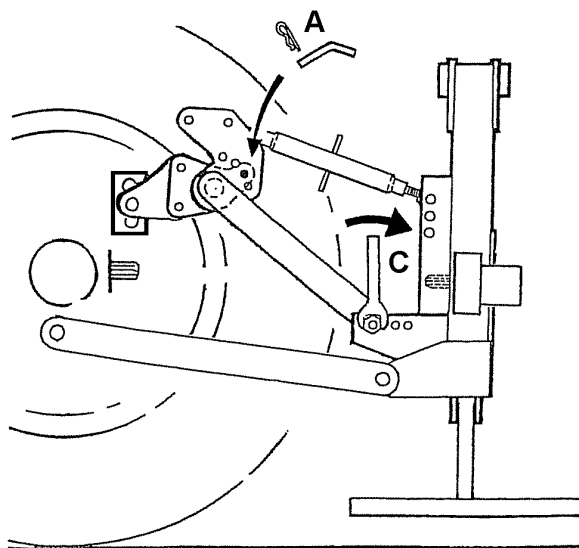

Asm-B-0089

ASSEMBLY

DRIVELINE ATTACHMENT

Before starting assembly, make certain that all paint, dirt, and grease are removed from gearbox shaft. To ease assembly apply a light coat of grease to splines and assemble. Do not assemble a driveline without a shield. Entanglement in rotating shafts can kill.

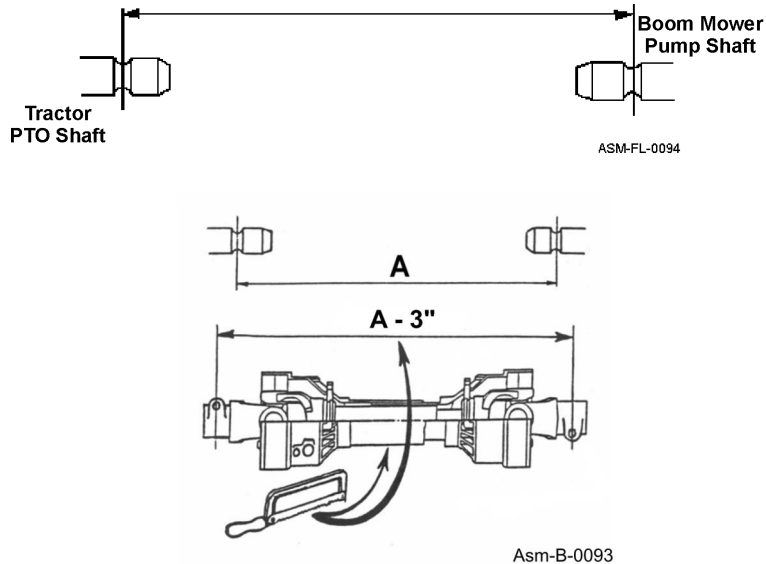

Measure distance shown between the tractor PTO Shaft and mower pump shaft. The driveline must collapse to 3" less than the measured dimension. It may be necessary to shorten the shaft. See Maintenance Section for procedures.

NOTE: The dimensions measured may vary on different tractors. If moving the mower to a different tractor, complete the measurement step again. If it is necessary to shorten the shaft, there must be at least 6" of shaft overlap in the operating position.

Fit PTO shaft and attach torque chain to prevent the shaft guard from rotating. (Figure Asm-B-0094)

Raise the stand legs into the work position and secure. (Figure Asm-B-0095)

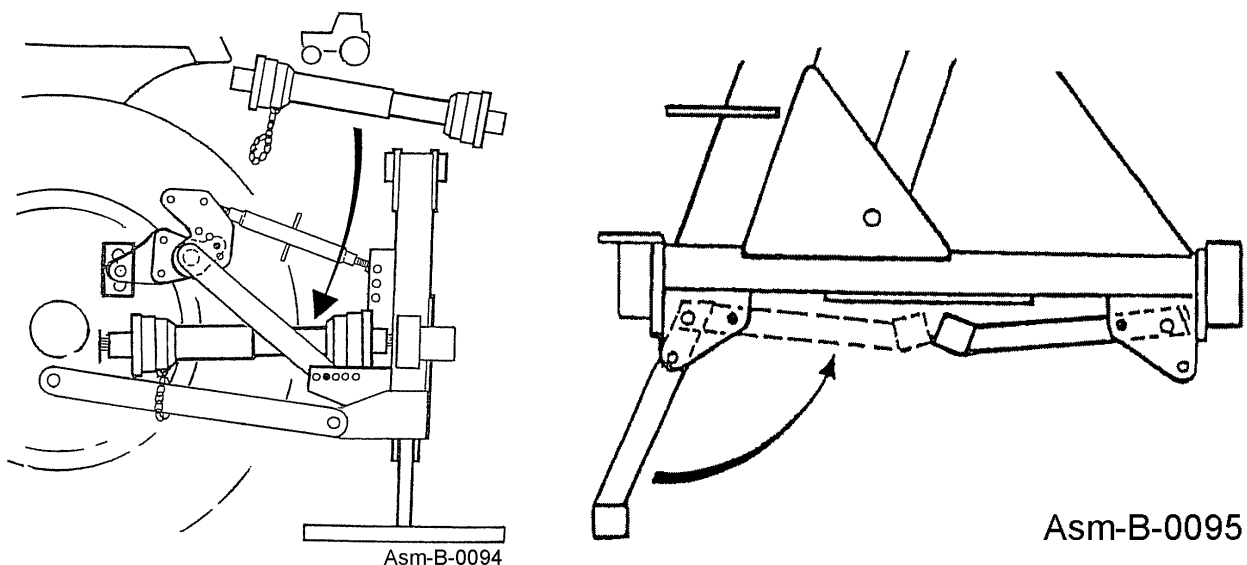

ASSEMBLY

ASSEMBLY

REMOVE TRANSPORT STRAP

With PTO engaged, maneuver the arms into a position that will allow the cutterhead to be fitted. Fit cutterhead and secure with circlip, washers, and cotter pin.

Cutterbar Only:

Engage the motor splines in the drive tube and bolt in position with connection uppermost.

HOSE ROUTING

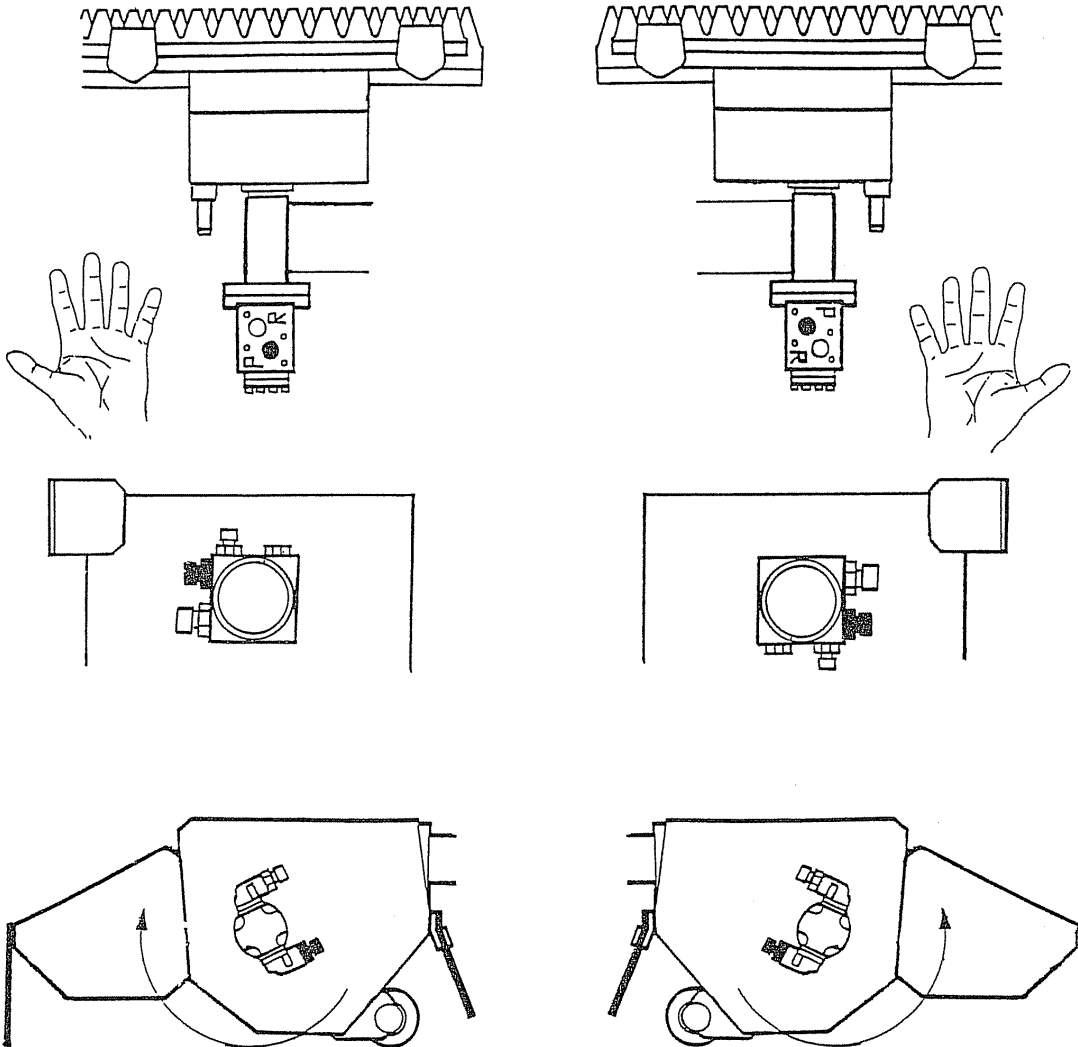

Asm-B-0101

FINAL ASSEMBLY CHECKS

1. With the arms at half reach and with the flail head clear of the ground carry out final adjustment of the lift arm leveling box to bring the main frame horizontal.
2. Tighten check chains and/or stabilizer bars.
3. Carefully operate the machine through its full range of movements while checking that hoses are not under tension, pinched, frayed, or kinked and that all movements are functioning correctly.
4. Fold the machine into the transport position. The machine is now ready to proceed to the work site. RMB

RMB 1445 08/22

Assembly Section 3-6

ASSEMBLY

ASSEMBLY

OIL REQUIREMENTS

Tank

The machine is delivered from the factory without oil. Before use, fill machine with approximately 21 gallons of oil. When changing oil fill the reservoir with a light hydraulic oil as recommended in the chart until the oil level is approximately 3" below the top of the tank. The total capacity is approximately 80 liters (21.14 gallons). Do not overfill. The oil must have anti-frothing characteristics suitable for use in hydraulic systems

Supplier	Cold or Temperate Climates	Hot Climate
Castrol	Agricastrol hydraulic oil Hy-spin AWS46	Hy-spin AWS68
Shell	Tellus 46	Tellus 68
Mobil	D.T.E. 25	D.T.E. 26
Esso	Nuto "H" or "A" 46	Nuto "H" or "A" 68
Texaco	Rando HD 46	Rando HD 68
Gulf	Hydrasil 46	Hydrasil 68
BP	Energal HLP 46	Energal HLP 68
Dalton	Silkolene Dove 46 or Derwnet 46	Silkolene Dove 68
Elf	Hydrelf 46	Hydrelf 68
ISO VG	46	68
SAE	10W	20

When adding hydraulic oil, use only new oil from a sealed barrel. Used oil or oil from an open barrel may contain high levels of contamination. Transfer the oil into the hydraulic tank by using a hydraulic filter pump unit equipped with a properly operating 10 micron filter. This will insure that the oil being added is clean. Do not just pour the oil directly into the hydraulic tank since most oils (even from a sealed barrel) have contaminants that should be removed, before operating the hydraulic system. **(Asm-B-0010 & Asm-B-0103)**

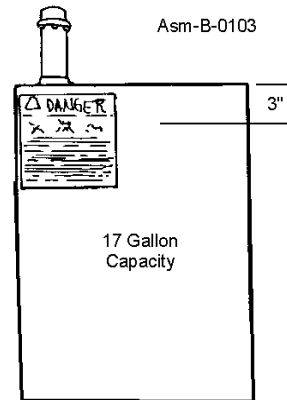
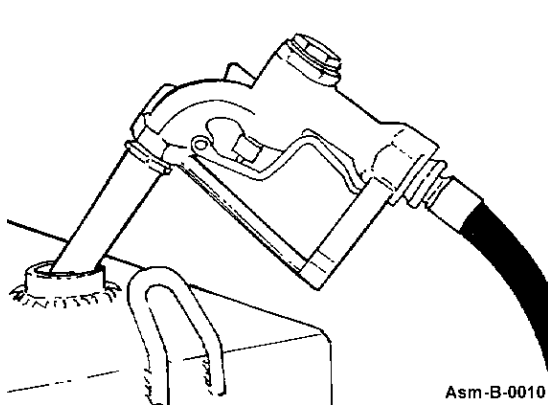

ASSEMBLY

Gearbox

Check the gearbox oil level. On level ground, gearbox should be filled until oil is visibly level with the lip of the filler plug aperture. Do not attempt to fill by removing the breather as the depth of tapped thread in the casing at this point is insufficient to allow repeated loosening and tightening of the breather plug.

The gearbox capacity is 1-1/2 pints. Use EP90 gear oil.

FITTING CONTROL UNIT IN CAB

An angled bracket is supplied to provide a mounting location for the control unit.

This bracket may be bolted to the fender or cab cladding in a convenient location ensuring that no structural member of the cab or roll bar is drilled.

In deciding the final position of the control box remember not to exceed the minimum acceptable bend radius of 8" for the cables.

When the control unit is removed from the cab ensure the rubber edge strip is fitted too the mounting bracket to cover any possible sharp edges.

RUNNING UP PROCEDURE

RMB 1445 With Flail Head ONLY

1. Ensure that the rotor control is in "STOP" position, start the tractor, engage PTO and allow the oil to circulate for about 5 minutes before operating the arms.
2. Operate the arm head levers through their complete range ensuring that all movements are functioning correctly.
3. Check that the flail nuts and bolts are tight. Place the flail head at a safe position and move the rotor control to "ON" position. After initial fluctuation due to priming, the rotor should settle to a steady speed. Increase PTO speed to approximately 360 RPM and run for a further five minutes before engaging and stopping tractor
4. Check the hose routing and observe that they are free from any pinching, chafing, straining or kinks. Recheck the oil level in the tank and top up as necessary.



CAUTION Do not allow the pump to continue working if the rotor does not turn. Overheating and serious pump damage to the pump can be caused in a very short time.

5. Replace return filter elements after an initial 12 hours of operation and every 500 hours thereafter.

All models:

Replace return filter elements after an initial 12 hours of operation and every 500 hours thereafter.

ASSEMBLY

REMOVAL FROM TRACTOR

1. Select a firm level site for parking the machine.
2. Lower the stand legs and lock.
3. Raise the machine until the weight is taken off the stabilizer.
4. Remove the stabilizer nose quadrant locking pin.
5. Lower the machine to the ground.
6. Operate machine controls and place the flail head on the ground.
7. Disengage tractor PTO and remove the drive shaft.
8. Disconnect stabilizers bars or loosen check chains as applicable.
9. Unbolt the control unit from the mounting bracket, remove from tractor cab and stow the lever in a suitable location clear of the ground. For units that have quick attach cables, uncouple the cables and leave the control unit in the cab of the tractor.
10. Raise the machine on the tractor's linkage to take the weight off the yoke and remove the lower yoke pins
11. Lower the tractor draft links and place machine firmly on the ground.
12. Remove draft links and top link from the machine, drive tractor away and remove yoke.

OPERATION SECTION

Operation Section 4-1

OPERATION

RMB 1445 REAR MOUNT BOOM MOWER OPERATING INSTRUCTIONS

Bush Hog Boom mowers are manufactured with quality material by skilled workers. These mowers are designed for cutting grass and small weeds. The mower is equipped with protective deflectors to prevent objects being thrown from the mower by the blades. However, no shielding is 100% effective. All shields, guards, and deflectors equipped on the mower must be maintained in good operational condition.

It is the operator's responsibility to be knowledgeable of all potential operating hazards and to take every reasonable precaution to ensure oneself, others, animals, and property are not injured or damaged by the mower, tractor, or a thrown object. Do not operate the mower if passersby, pets, livestock, or property are within 300 yards of the unit.

- **ALL THROWN OBJECT SHIELDING** including, Front, Rear Deflectors and Skid Shoes are in place and in good condition when mowing.
- Mower is adjusted to be close and parallel to ground without exposing blades.
- **MOWING AREA** has been inspected and foreign materials and debris have been removed.
- **PASSERSBY** are inside enclosed vehicle.

This section of the Operator's Manual is designed to familiarize, instruct, and educate safe and proper mower use to the operator. Pictures contained in this section are intended to be used as a visual aid to assist in explaining the operation of a flail mower and are not specific to any model. Some pictures may show shields removed for picture clarity. NEVER operate implement without all shields in place and in good operational condition. The operator must be familiar with the mower and tractor and all associated safety practices before operating the mower and tractor. Proper operation of the mower, as detailed in this manual, will help ensure years of safe and satisfactory use of the mower.

IMPORTANT: To avoid mower damage, retorque all bolts after the first 10 hours of operation. Refer to the torque Chart at the end of the Maintenance Section to ensure bolts are properly tightened.

READ AND UNDERSTAND THE ENTIRE OPERATING INSTRUCTIONS AND SAFETY SECTION OF THIS MANUAL AND THE TRACTOR MANUAL BEFORE ATTEMPTING TO USE THE TRACTOR AND IMPLEMENT. If you do not understand any of the instructions, contact your nearest authorized dealer for a full explanation. Pay close attention to all safety signs and safety messages contained in this manual and those affixed to the implement and tractor. *OPS-U- 0001str*

READ, UNDERSTAND, and FOLLOW the following Safety Messages. Death or serious injury may occur unless care is taken to follow the warnings and instructions stated in the Safety Messages. Always use good common sense to avoid hazards. (SG-2str)



PELIGRO

Si no lee ingles, pida ayuda a alguien que si lo lea para que le traduzca las medidas de seguridad. (SG-3) str

¡ LEA EL INSTRUCTIVO!



OPERATION

1. STANDARD SPECIFICATIONS

Description	Specification
Hitch	3-Point CAT I
Tractor PTO Horsepower (Minimum)	45 HP
Tractor Weight (Minimum)	4410 lbs
Boom Reach	14'3"
Cutting Capacity: Flail Head	1"
Cutting Capacity: Sickle Bar	1-1/4"
Cutting Width: Flail Head	39"
Cutting Width: Sickle Bar	59"
Hydraulics	Totally Independent, self-contained
Approximate Weight with Flail Head	1,220 lbs
Oil Tank Capacity	17.4 gallons

FEATURES

- Parallel Arm Geometry
- Safety Breakaway - Hydraulic
- Heavy Duty Rear Roller
- Front Flap Kit
- Cable Rotor Control - Dual Rotation
- Window Guards
- Attachments:
 - Model F39 Flail
 - Model S58 Cutterbar

DIMENSIONS

- A. Maximum Reach - Head Horizontal 14'1"
- B. Maximum Reach - Head Vertical 13'0"
- C. Maximum Height - Head Horizontal 13'5"
- D. Maximum Height - Head Vertical 13'8"
- E. Maximum Depth - Head at 45° 7'3"
- F. Sliding Width - Head Vertical 5'6"

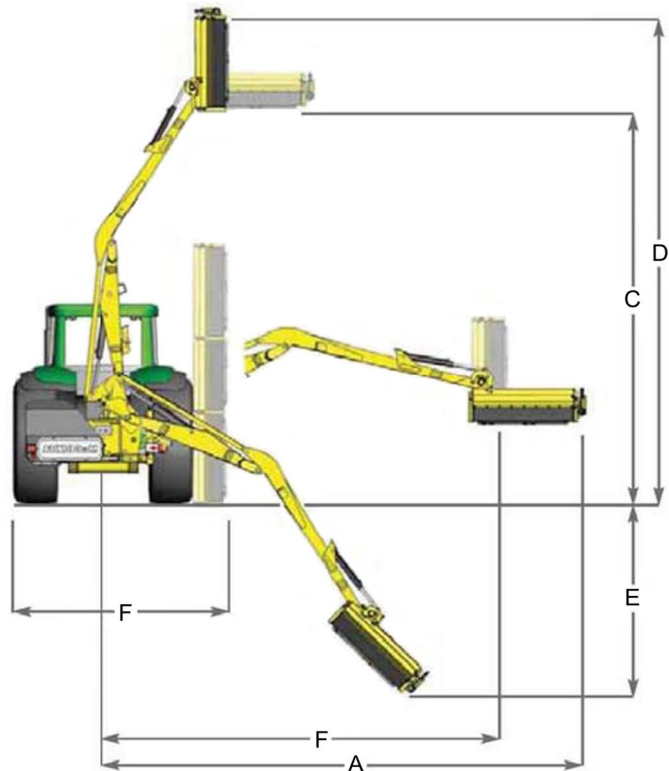

OPERATION

2. OPERATOR REQUIREMENTS

Safe operation of the unit is the responsibility of a qualified operator. A qualified operator has read and understands the implement and tractor Operator's Manuals and is experienced in implement and tractor operation and all associated safety practices. In addition to the safety messages contained in this manual, safety signs are affixed to the implement and tractor. If any part of the operation and safe use of this equipment is not completely understood, consult an authorized dealer for a complete explanation.

If the operator cannot read the manuals for themselves or does not completely understand the operation of the equipment, it is the responsibility of the supervisor to read and explain the manuals, safety practices, and operating instructions to the operator.

Safe operation of equipment requires that the operator wear approved Personal Protective Equipment (PPE) for the job conditions when attaching, operating, servicing, and repairing the equipment. PPE is designed to provide operator protection and includes the following safety wear:

PERSONAL PROTECTIVE EQUIPMENT (PPE)

- Always Wear Safety Glasses (with side shields marked to comply with ANSI Z87)
- Hard Hat
- Steel Toe Safety Footwear
- Gloves
- Hearing Protection
- Close Fitting Clothing
- Respirator or Filter Mask (depends on operating conditions)

OPS-U- 0002str

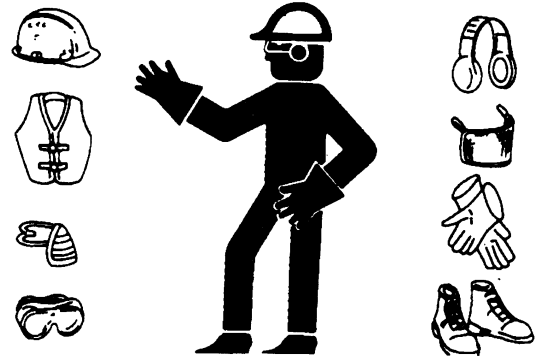

⚠ DANGER

DO NOT use drugs or alcohol immediately before or while operating the Tractor and Implement. Drugs and alcohol will affect an operator's alertness and coordination and therefore affect the operator's ability to operate the equipment safely. Before operating the Tractor or Implement, an operator on prescription or over-the-counter medication must consult a medical professional regarding any side effects of the medication that would hinder their ability to operate the Equipment safely. NEVER knowingly allow anyone to operate this equipment when their alertness or coordination is impaired. Serious injury or death to the operator or others could result if the operator is under the influence of drugs or alcohol.

(SG-27) str

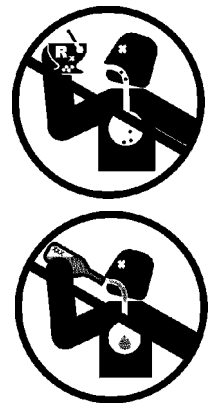

OPERATION

3. TRACTOR REQUIREMENTS

In addition to tractor horsepower and size required to operate the boom unit, the tractor must also be properly equipped to provide operator protection, to alert approaching vehicle drivers of the tractor's presence, and to ensure tractor stability when mowing with the boom fully extended.

Tractor Requirements and Capabilities

- Certified approved Roll-Over Protective Structure (ROPS) or ROPS cab and seat belt.
- Operator Protection Tractor must be equipped with protective structure such as operator cage or lexan window to protect operator from thrown object and falling objects.
- Tractor Safety Devices Slow Moving Vehicle (SMV) emblem, lighting,
- Tractor Ballast As required to maintain at least 1500 lbs. on left rear tire

3.1 ROPS and Seat Belt

The tractor must be equipped with a Roll-Over-Protective-Structure (ROPS), tractor cab, or roll-bar and seat belt to protect the operator from falling off the tractor, especially during a roll over where the driver could be crushed and killed. Only operate the tractor with the ROPS in the raised position and seat belt fastened. Tractor models not equipped with a ROPS and seat belt should have these life saving features installed by an authorized dealer. OPS-U- 0003str



Operate this Equipment only with a Tractor equipped with an approved roll-over-protective system (ROPS). Always wear seat belts. Death or serious injury could result from falling off the tractor, particularly during a turnover when the operator could be pinned under the ROPS. (SG-7) str



3.2 Operator Thrown Object Protection

The tractor must be equipped with protective equipment to shield the operator from falling and thrown objects. For cab tractors, the tractor must be equipped with an operator safety screen on its right side or the right side windows must be fitted with a shatter resistant safety window. OPS-B- 0001_Bstr



Never operate the Tractor and Mower Unit without an OPS (Operators Protective Structure) or Cab to prevent injury from objects thrown from ground or from overhead trimming. Stop mowing if workers or passersby are within 300 feet. (SBM-9str)

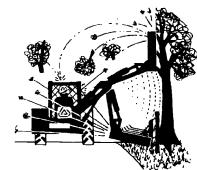

OPERATION

3.3 Tractor Lighting and SMV Emblem

If the tractor will be operated near or traveled on a public roadway it must be equipped with proper warning lighting and a Slow Moving Vehicle (SMV) emblem which are clearly visible from the rear of the unit. Most tractors have different settings for operating and transporting lighting. Refer to the tractor operator's manual for using the tractor's light switch and operating the turn signals. OPS-B-0017str



Op-86

3.4 Tractor Ballast

To ensure tractor stability when operating on flat surfaces the left rear tractor tire MUST exert a minimum down force (weight) of 1500 lbs. on the ground when the tractor is on level ground, its boom is fully extended and the mower head is horizontal and two feet above the ground. A tractor that does not meet this criteria is DANGEROUS and should not be operated as upset of the unit can occur resulting in possible serious injury and property damage.

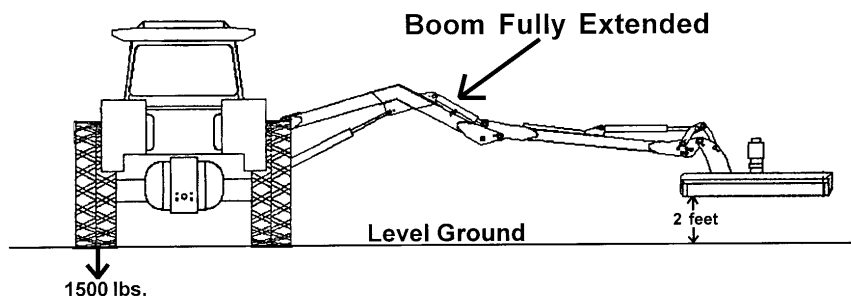

Op-71

If the unit is operated on slopes greater than 5°, additional counterweight will be required. Operation of the unit on slopes greater than 11 percent (6.4 degrees) is not recommended under any circumstances. On a tractor with a 96" outside to outside tire spread, an 11 percent (6.4 degrees) slope occurs when one rear tractor tire is about 8" lower than the other rear tire.

OPS-B-0018_C str

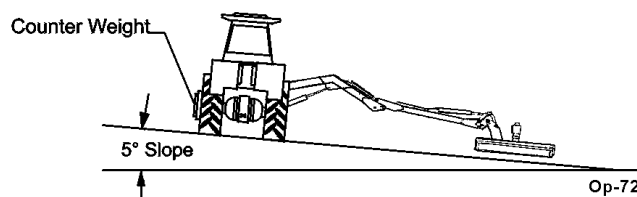

3.5 Tractor Safety Devices

If transporting or operating the tractor and implement near a public roadway, the tractor must be equipped with proper warning lighting and a Slow Moving Vehicle (SMV) emblem which are clearly visible from the rear of the unit. Lights and a SMV emblem must be equipped directly on implements if the visibility of the tractor warning signals are obscured.

Maintain all manufacturer equipped safety shields and guards. Always replace shields and guards that were removed for access to connect, service, or repair the tractor or implement. Never operate the tractor PTO with the PTO master shield missing or in the raised position. OPS-U-0004str

OPERATION

3.6 Tractor Horsepower

The horsepower required to operate the mower depends on many factors including vegetation to be cut, terrain condition, operator experience, and condition of the mower and tractor. For most mowing condition, the RMB 1445 flail trimmer requires a tractor with at least 45 PTO HP. Operating the mower with a tractor that does not have adequate power may damage the tractor engine.

3.7 3-Point Hitch

RMB 1445 boom mowers can attach to tractors with a CAT I hitch. Refer to the tractor operator's manual for the category of the tractor used. If the hitch does not conform to ASABE Cat I dimensions, the mower may not fit or raise properly. Consult an authorized dealer for possible modification procedures to mount nonconforming hitches.

Use the correct hitch pins.

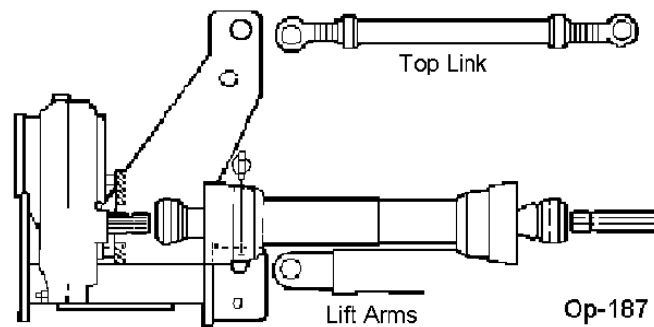

IMPORTANT: Scan this QR Code with your smart phone to link to the PAMI Safe Implement Hitching Manual for more information on correctly connecting agricultural tractors to implements. Or type in your internet browser the following web address: www.algqr.com/hme_Ops-0008-MISC_str

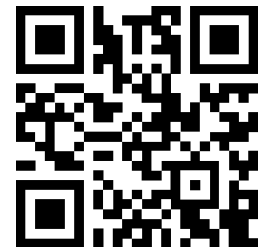

3.8 Hydraulics

The RMB 1445 is provided with a Totally Independent, Self-Contained Hydraulic System (pump is powered by the tractor PTO) complete with rotor rotation control. The fully independent system is operated by an extra lever on the control console, which allows selection of rotor rotation and all other functions.

3.9 Front End Weight

A minimum of 20% total tractor weight must be maintained on the tractor front end at all times. Front end weight is critical to maintain steering control and to prevent the tractor from rearing up while driving. If the front end is too light, add weight until a minimum of 20% total weight is reached on the front tires. Front weights and weight carriers can be purchased through an authorized tractor dealership. OPS-U-0005 str

3.10 Power Take Off (PTO)

Depending on the unit, the mower is designed to operate at a PTO speed of 540 RPM. Most tractors operate at either 540, or a combination of 540 and 1000 RPM PTO speeds. The operating speed of the mower and tractor can be determined by the number of splines on the driveline yoke and PTO output shaft. Those operating at 540 RPM will have a 6-spline shaft and those operating at 1000 RPM will have a 21-spline shaft or a 1-3/4" 20 spline shaft. Refer to the tractor owner's manual for instructions to change PTO speeds on models that operate at more than one speed.

If operating an older model tractor where the tractor's transmission and PTO utilize one master clutch, an over-running clutch must be used between the PTO output shaft and the driveline of the mower. An authorized tractor dealer can provide the over-running clutch and its installation if needed. OPS-U-0006_E str

OPERATION



DO NOT use a PTO adapter to attach a non-matching Implement driveline to a Tractor PTO. Use of an adapter can double the operating speed of the Implement resulting in excessive vibration, thrown objects, and blade and implement failure. Adapter use will also change the working length of the driveline exposing unshielded driveline areas. Serious bodily injury and/or equipment failure can result from using a PTO adapter. Consult an authorized dealer for assistance if the Implement driveline does not match the Tractor PTO. (S3PT-14) str



Never operate the Tractor and Mower if the Implement input driveline is directly connected to the Tractor transmission. Tractor braking distances can be substantially increased by the momentum of the rotating Mower blades driving the Tractor transmission even though the Tractor clutch has been disengaged. Install an over running clutch between the Tractor PTO and the Mower driveline to prevent this potentially dangerous situation. (S3PT-16) str

4.GETTING ON AND OFF THE TRACTOR

Before getting onto the tractor, the operator must read and completely understand the implement and tractor operator manuals. If any part of either manual is not completely understood, consult an authorized dealer for a complete explanation. OPS-U- 0007str



Do not mount or dismount the Tractor while the tractor is moving. Mount the Tractor only when the Tractor and all moving parts are completely stopped. Dismounting a moving power unit can result in a crushing hazard that can cause death or serious injury. (SG-12) str



4.1 Boarding the Tractor

Use both hands and equipped handrails and steps for support when boarding the tractor. Never use control levers for support when mounting the tractor. Seat yourself in the operator's seat and secure the seat belt around you.

Never allow passengers to ride on the tractor or attached equipment. Riders can easily fall off and be seriously injured or killed from falling off and being ran over. It is the operator's responsibility to forbid all extra riders at all times. OPS-U- 0008str



Never allow children or other persons to ride on the Tractor or Implement. Falling off can result in death or serious injury. (SG-10)str



Never allow children to operate or ride on the Power Unit or Implement. (SPU-17) str



OPERATION

4.2 Dismounting the Tractor

Before dismounting, park the tractor and implement on a reasonably level surface, apply the parking brake, idle the engine down, disengage the PTO, and lower the implement to the ground. Shut down the tractor engine according to the operator's manual, remove the key, and wait for all motion to completely stop. Never leave the seat until the tractor, its engine and all moving parts have come to a complete stop.

Use hand rails and steps when exiting the tractor. Be careful of your step and use extra caution when mud, ice, snow or other matter has accumulated on the steps or hand rails. Use all handrails and steps for support and never rush or jump off the tractor. OPS-U- 0009 str



BEFORE leaving the tractor seat lower the implement, set the parking brake and/or set the tractor transmission in parking gear, disengage the PTO, stop the engine, remove the key, and wait for all moving parts to stop. Place the tractor shift lever into a low range or parking gear to prevent the tractor from rolling. Never dismount a Tractor that is moving or while the engine is running. Operate the Tractor controls from the tractor seat only.

(SG-9)str

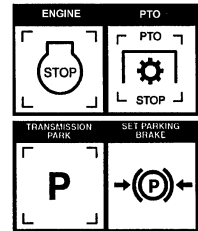

5.STARTING THE TRACTOR

The operator must have a complete understanding of the placement, function, and operational use of all tractor controls before starting the tractor. Review the tractor operator's manual and consult an authorized dealer for tractor operation instructions if needed.

Essential Tractor Controls:

- Locate the ignition key/switch
- Locate the engine shut off control
- Locate the hydraulic control levers
- Locate the light control lever
- Locate the brake pedals and clutch
- Locate the PTO control
- Locate the 3 point hitch control lever
- Locate the boom operating controls (joystick or valve bank)

Before starting the tractor ensure the following:

- Conduct all pre-start operation inspection and service according to the tractor operator's manual.
- Make sure all guards, shields, and other safety devices are securely in place.
- The parking brake is on.
- The tractor transmission levers are in park or neutral.
- The boom operating controls are in the neutral and off position.
- The PTO control lever is disengaged.
- The hydraulic remote control levers are in the neutral position.

Refer to the tractor owner's manual for tractor starting procedures. Only start the tractor while seated and belted in the tractor operator's seat. Never bypass the ignition switch by short circuiting the starter solenoid. After the tractor engine is running, avoid accidental contact with the tractor transmission to prevent sudden and unexpected tractor movement. OPS-B- 0003str



Never run the Tractor engine in a closed building or without adequate ventilation. The exhaust fumes can be hazardous to your health. (SG-23) str

OPERATION

WARNING

Avoid contact with hot surfaces including hydraulic oil tanks, pumps, motors, valves and hose connections. Relieve hydraulic pressure before performing maintenance or repairs. Use gloves and eye protection when servicing hot components. Contact with a hot surface or fluid can cause serious injury from burns or scalding. (SG-34str)

DANGER

Always shut the Tractor completely down, place the transmission in park, and set the parking brake before you or anyone else attempts to connect or disconnect the Implement and Tractor hitches. (S3PT-15) str

WARNING

Periodically inspect all moving parts for wear and replace when necessary with authorized service parts. Look for loose fasteners, worn or broken parts, and leaky or loose fittings. Make sure all pins have cotter pins and washers. Serious injury may occur from not maintaining this machine in good working order. (SG-21) str

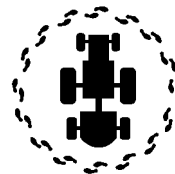

DANGER

Never work under the Implement, the framework, or any lifted component unless the Implement is securely supported or blocked up to prevent sudden or inadvertent falling which could cause death or serious injury. (SG-14)str



DANGER

All Safety Shields, Guards and Safety devices including (but not limited to) - the Deflectors, Chain Guards, Steel Guards, Gearbox Shields, PTO integral shields, and Retractable Door Shields should be used and maintained in good working condition. All safety devices should be inspected carefully at least daily for missing or broken components. Missing, broken, or worn items must be replaced at once to reduce the possibility of injury or death from thrown objects, entanglement, or blade contact. (SBM-18) str

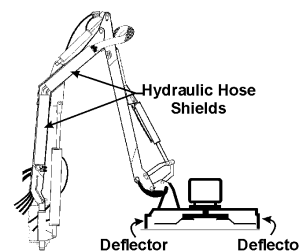

DANGER

Use extreme caution when raising the Mower head. Stop the Blades from turning when the Mower Head is raised and passersby are within 300 feet. Raising the Mower head exposes the Cutting Blades which creates a potentially serious hazard and can cause serious injury by objects thrown from the Blades or by contact with the Blades. (SBM-2) str

OPERATION

6. PRE-OPERATION INSPECTION AND SERVICE

Before each use, a pre-operation inspection and service of the implement and tractor must be performed. This includes routine maintenance and scheduled lubrication, inspecting that all safety devices are equipped and functional, and performing needed repairs. DO NOT operate the unit if the pre-operation inspection reveals any condition affecting safe operation. Perform repairs and replacement of damaged and missing parts as soon as noticed. By performing a thorough pre-operation inspection and service, valuable down time and repair cost can be avoided. OPS-U-0029str



Periodically inspect all moving parts for wear and replace when necessary with authorized service parts. Look for loose fasteners, worn or broken parts, and leaky or loose fittings. Make sure all pins have cotter pins and washers. Serious injury may occur from not maintaining this machine in good working order. (SG-21)str



OPERATION

6.1 Tractor Pre-Operation Inspection and Service

Refer to the tractor operator's manual to ensure a complete pre-operation inspection and scheduled service is performed according to the manufacturer's recommendations. The following are some of the items that require daily service and inspection:

- Tire condition/air pressure
- Wheel lug bolts
- Steering linkage
- PTO shield
- SMV sign is clean and visible
- Tractor's lights are clean and functional
- Tractor Seat belt is in good condition
- ROPS is in the raised position
- No tractor oil leaks
- Radiator free of debris
- Engine oil level and condition
- Engine coolant level and condition
- Power brake fluid level
- Power steering fluid level
- Fuel condition and level
- Sufficient lubrication at all lube points
- Air filter condition OPS-U-0030 str



OPERATION

6.2 Boom Unit Pre-Operation Inspection and Service

Inspect and service the boom arm and head prior to operation. Damaged and/or broken parts should be repaired and/or replaced immediately. To ensure the unit is ready for operation, conduct the following:
OPS-B- 0020str



All Safety Shields, Guards and Safety devices including (but not limited to) - the Deflectors, Steel Guards, Gearbox Shields, PTO integral shields, and Retractable Door Shields should be used and maintained in good working condition. All safety devices should be inspected carefully at least daily for missing or broken components. Missing, broken, or worn items must be replaced at once to reduce the possibility of injury or death from thrown objects, entanglement, or blade contact. (SFL-05) str

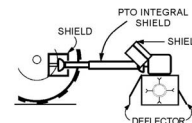

Replace bent or broken blades with new blades. NEVER ATTEMPT TO STRAIGHTEN, WELD, OR WELD HARDFACING ON BLADES SINCE THIS WILL LIKELY CRACK OR OTHERWISE DAMAGE THE BLADE WITH SUBSEQUENT FAILURE AND POSSIBLY CAUSE SERIOUS INJURY FROM THROWN BLADES. (SGM-10) str

The operator's manual and safety signs affixed on the unit contain important instructions on the safe and proper use of the equipment. Maintain these important safety features on the implement in good condition to ensure the information is available to the operator at all times.

- Ensure the manual canister is secured to the equipment with the operator's manual inside.
- Ensure all safety signs are in place and legible. Replace missing, damaged, and illegible decals. OPS-U- 0011 str



Op-14

NOTE: The mower Operator's Manual and affixed Decals contain important instructions on the safe and proper use of the mower. Maintain these important safety features on the mower in good condition to ensure the information is available to the operator at all times.



KEEP AWAY FROM ROTATING ELEMENTS to prevent entanglement and possible death or serious injury. (SG-24)str



OPERATION

FRAME ASSEMBLY

- Ensure all bolts and screws are in position and are properly torqued.
- Ensure all pins are in place and fastened with screws.
- Ensure frame is properly mounted to tractor and hardware is properly installed and tightened. *OPS-B-0021_H str*



BOOM ARM ASSEMBLY

- Inspect condition of each arm section weldment
- Ensure all pins are in place.
- Ensure all bolts and screws are properly installed.
- Check condition of teflon bushings at boom pivot points.
- Ensure each hydraulic cylinder is installed and retained correctly. Ensure the proper size pins are used to retain the cylinders in place and are secured properly.
- Ensure that all joints are lubricated. See Maintenance Section for Lubrication Chart. *OPS-B-0022_K str*



Never attempt to lubricate, adjust, or remove material from the Implement while it is in motion or while tractor engine is running. (SG-20)str

HYDRAULIC LINE INSPECTION

- Check for hydraulic leaks along hoses, cylinders and fittings. **IMPORTANT: DO NOT use your hands to check for oil leaks.** Use a piece of heavy paper or cardboard to check for hydraulic oil leaks.
- Inspect the condition of the valve weldment.
- Ensure fitting is properly connected.
- Inspect condition of nylon bushings. *OPS-B-0023_Dstr*

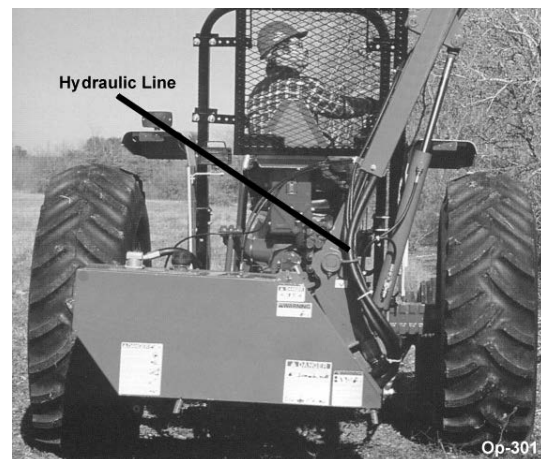

OPERATION

WARNING

Relieve hydraulic pressure prior to doing any maintenance or repair work on the Implement. Place the Mower Head on the ground or securely supported on blocks or stands, disengage the PTO, and turn off the engine. Push and pull the control Levers or Joystick several times to relieve pressure prior to starting any maintenance or repair work. (SBM-6str)

WARNING

Never leave the mower unattended while the head is in the raised position. The mower could fall causing serious injury to anyone who might inadvertently be under the mower. (SBM-4str)



WARNING

Do not operate this Equipment with hydraulic oil or fuel leaking. Oil and fuel are explosive and their presence could present a hazard. Do not check for leaks with your hand! High-pressure oil streams from breaks in the line could penetrate the skin and cause tissue damage including gangrene. To check for a hose leak, SHUT the unit ENGINE OFF and remove all hydraulic pressure. Wear oil impenetrable gloves, safety glasses and use cardboard to check for evidence of oil leaks. If you suspect a leak, REMOVE the HOSE and have it tested at a Dealer. If oil does penetrate the skin, have the injury treated immediately by a physician knowledgeable and skilled in this procedure. (SG-15) str



HYDRAULIC PUMP/OIL RESERVOIR

- Check oil reservoir level and oil condition. (Add specific type oil if low)
- Change hydraulic oil filter and hydraulic oil according to maintenance schedule.
- Ensure there are no oil leaks and fitting are properly connected.
- Inspect overall condition of hydraulic pump.
- Inspect pump drive shaft.



Op-565

Check the fluid level in the Hydraulic Tank, and add oil if required. As the air has been forced out of the Cylinders and Hoses, it goes into the Hydraulic Tank and reduces the volume of oil. Maintain the oil level within the sight gauge located on the side of the reservoir. Never fill the tank above the sight gauge to allow for the expansion of the oil. The tank maintains pressure after the mower has been run. Stand off to one side when removing the breather cap element to prevent possible injury. To relieve pressure remove the breather cap element and depress the spring loaded pressure valve to release any excess air. OPS-B- 0024_K str

WARNING

Attention: Oil Filler Cap is also the Pressure Relief Cap.

Remove cap slowly to relieve pressure before removing cap completely. Stay clear to prevent being scalded with hot oil that may spray out of the tank that is still pressurized and may cause serious injury to eyes, face, and exposed skin. (Ops-0001-MISC str)

OPERATION

WARNING

Avoid contact with hot surfaces including hydraulic oil tanks, pumps, motors, valves and hose connections. Relieve hydraulic pressure before performing maintenance or repairs. Use gloves and eye protection when servicing hot components. Contact with a hot surface or fluid can cause serious injury from burns or scalding. (SG-34str)

WARNING

Do not operate this Equipment with hydraulic oil or fuel leaking. Oil and fuel are explosive and their presence could present a hazard. Do not check for leaks with your hand! High-pressure oil streams from breaks in the line could penetrate the skin and cause tissue damage including gangrene. To check for a hose leak, SHUT the unit ENGINE OFF and remove all hydraulic pressure. Wear oil impenetrable gloves, safety glasses and use cardboard to check for evidence of oil leaks. If you suspect a leak, REMOVE the HOSE and have it tested at a Dealer. If oil does penetrate the skin, have the injury treated immediately by a physician knowledgeable and skilled in this procedure. (SG-15) str



OPERATION

FLAIL HEAD INSPECTION

- Inspect blades and blade bolts for looseness and excessive wear. Rotate to 90° to make checking easier. Replace damaged, worn, and missing blades as complete sets to maintain cuttershaft balance.
- Ensure rubber deflectors are in position and not damaged. Replace worn, broken, and missing sections immediately.
- Ensure the rollers are in good condition and rotate freely.
- Inspect that all bolts and screws are in position and are properly torqued.
- Ensure hydraulic lines are properly connected to the hydraulic motor. Check for hydraulic leaks along hoses and fittings. DO NOT use your hands to check for oil leaks. Use a piece of heavy paper or cardboard to check for hydraulic oil leaks.
- Remove any grass or other debris which may be wrapped around the cuttershafts ends.
- Inspect the condition of deck skid shoes and hardware. OPS-B- 0026_C str



OPERATION

SICKLEBAR INSPECTION

- Inspect blades and blade bolts for looseness and excessive wear. Replace damaged, worn, and missing blades.
- Ensure guards are in position and not damaged. Replace worn, broken, and missing guards.
- Inspect that all bolts and screws are in position and are properly torqued.
- Ensure hydraulic lines are properly connected to the hydraulic valve and cylinders. Check for hydraulic leaks along hoses and fittings. DO NOT use your hands to check for oil leaks. Use a piece of heavy paper or cardboard to check for hydraulic oil leaks.
- Ensure hydraulic cylinder is installed and retained correctly. Ensure the proper size pins are used to retain the cylinder in place and are secured with pins.
- Remove any grass or other debris which may be wrapped around the cylinder.

OPS-B- 0063 str



▲ DANGER

Do not put hands or feet near the cutter bar. Blade contact can result in serious injury. Stay away until all motion has stopped and the mower is securely blocked up. (SSM-01str)



▲ WARNING

Do not operate this Equipment with hydraulic oil or fuel leaking. Oil and fuel are explosive and their presence could present a hazard. Do not check for leaks with your hand! High-pressure oil streams from breaks in the line could penetrate the skin and cause tissue damage including gangrene. To check for a hose leak, SHUT the unit ENGINE OFF and remove all hydraulic pressure. Wear oil impenetrable gloves, safety glasses and use cardboard to check for evidence of oil leaks. If you suspect a leak, REMOVE the HOSE and have it tested at a Dealer. If oil does penetrate the skin, have the injury treated immediately by a physician knowledgeable and skilled in this procedure. (SG-15) str



OPERATION

TRACTOR PRE-OPERATION INSPECTION



Tractor ID# _____ Make: _____

Date: _____ Shaft: _____



WARNING

Before conducting the inspection, make sure the tractor engine is off, all rotation has stopped and the tractor is in park with the parking brake engaged. Make sure the implement is resting on the ground or securely blocked up and all hydraulic pressure has been relieved.

OPERATION

Item	Condition at Start of Shift	Specific Comments if not OK
The flashing lights function properly		
The SMV Sign is clean and visible		
The tires are in good condition with proper pressure		
The wheel lug bolts are tight		
The tractor brakes are in good condition		
The steering linkage is in good condition		
There are no visible oil leaks		
The hydraulic controls function properly		
The ROPS or ROPS Cab is in good condition		
The seatbelt is in place and in good condition		
The 3-point hitch is in good condition		
The drawbar pins are securely in place		
The PTO master shield is in place		
The engine oil level is full		
The brake fluid level is full		
The power steering fluid level is full		
The fuel level is adequate		
The engine coolant fluid level is full		
The radiator is free of debris		
The air filter is in good condition		

Operator's Signature: _____

DO NOT OPERATE an UNSAFE TRACTOR or IMPLEMENT

OPERATION

BUSH HOG BOOM MOWER PRE-OPERATION INSPECTION



Boom ID# _____
 Make: _____
 Date: _____
 Shaft: _____

IMPORTANT:
 Scan this QR
 Code for an
 electronic copy of
 this inspection
 sheet.

Inspection Sheet



www.algqr.com/bmi

OPERATION



WARNING Before conducting the inspection, make sure the tractor engine is off, all rotation has stopped and the tractor is in park with the parking brake engaged. Make sure the mower is resting on the ground or securely blocked up and all hydraulic pressure has been relieved.

Item	Condition at Start of Shift	Specific Comments if not OK
The Operator's Manual is in the canister on the mower		
All safety decals are in place and legible		
The Mounting frame bolts are in place and tight		
The Boom connection bolts & pins are tight		
There are no cracks in boom		
The Hydraulic Cylinders pins are tight		
The Hydraulic Pump hose connections are tight		
The Hydraulic Valve hose connections are tight		
The Hydraulic Valve controls function properly		
There are no leaking or damaged hoses		
The Hydraulic Oil level is full		
There is no evidence of Hydraulic leaks		
The Blades are not chipped, cracked or bent		
The Blade bolts are tight		
The Deflectors are in place and in good condition		
The Mower shields are in place and in good condition		
The Skid shoes are in good condition & tight		
There are no cracks or holes in mower deck		
The Hyd. motor mounting bolts are tight		
The mower head spindle housing is tight and lubricated		

Operator's Signature: _____

DO NOT OPERATE an UNSAFE TRACTOR or MOWER

OPERATION

OPERATION

7.MACHINE CONTROLS

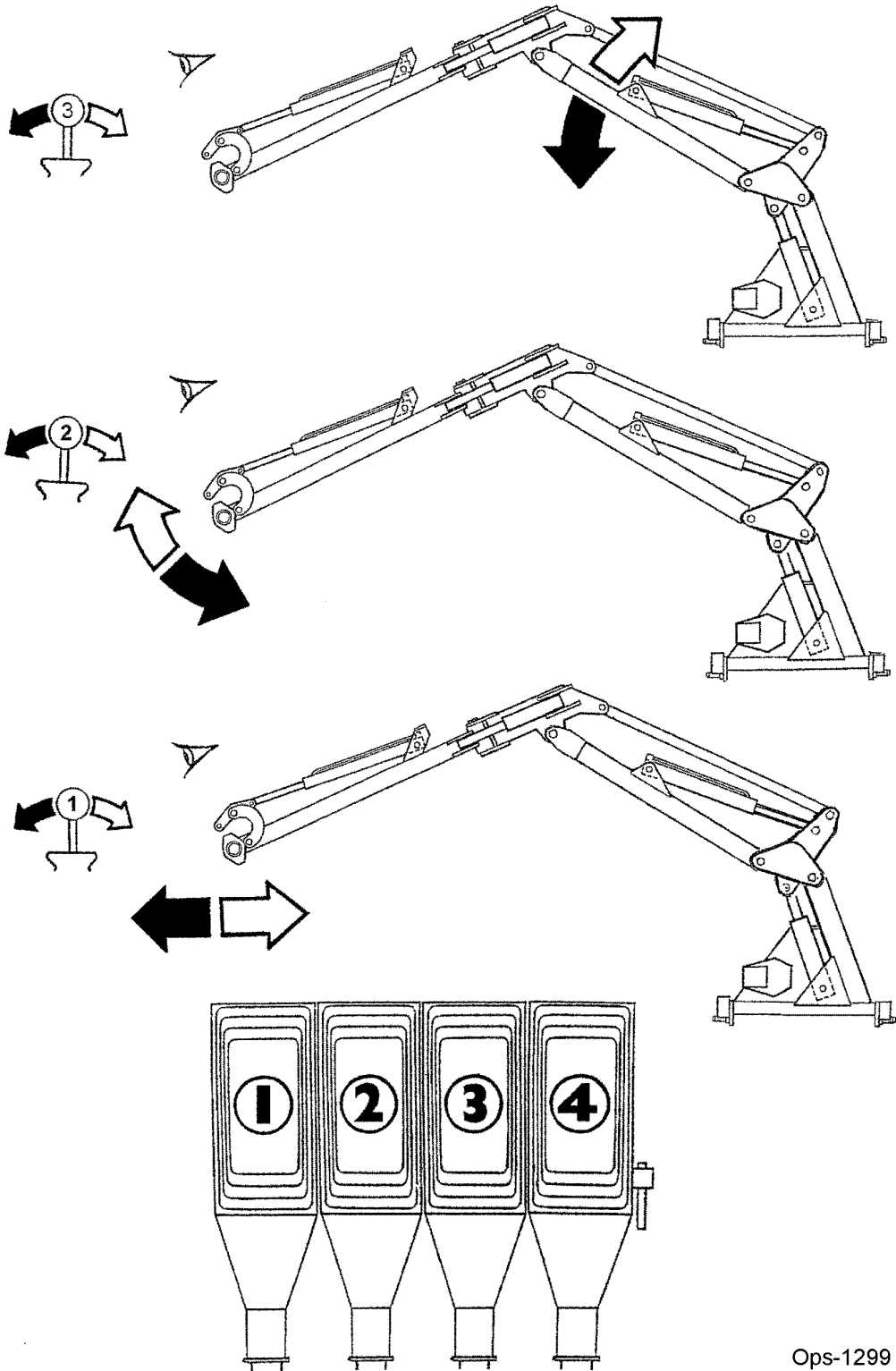

Ops-1299

OPERATION

OPERATION

8. ROTOR CONTROLS

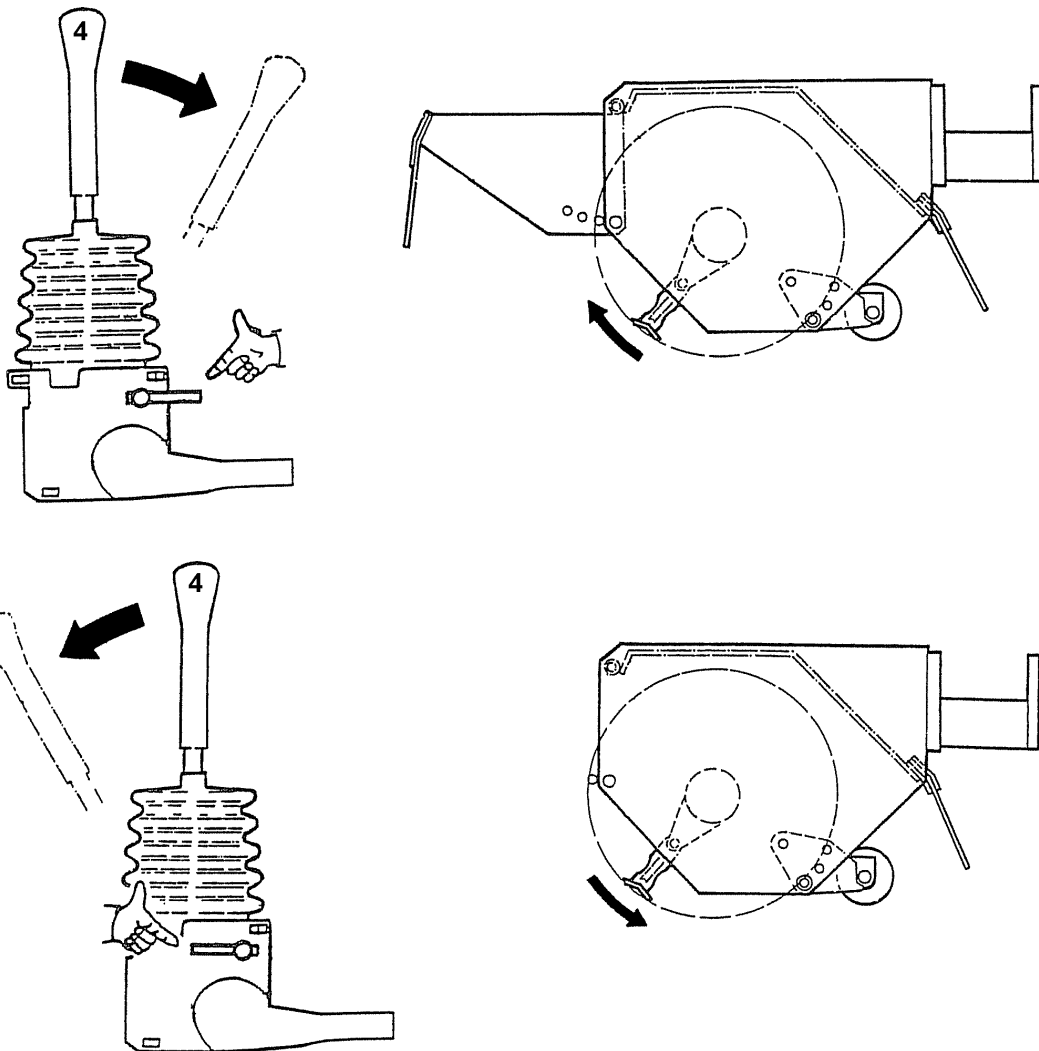

Reversing Rotation - With Flailhead

Select "ROTOR OFF"

Wait until the rotor has stopped turning.

Turn the small lever on the side of the rotor control lever pivot box 180 degrees. This will reset the control lever stop inside the pivot box and allow opposite rotation to be selected.

Reversing Rotation - With Sicklebar

Always pull the lever towards the operator to start cutterbar operation.

Never reverse cutting direction.

OPERATION

8.1 Angle Float

The selection of angle float on the control box simultaneously connects both gland and base side of the angling ram to tank.

The ram rod can then extend and retract freely allowing the flail head to automatically follow the contours of the ground.

Angle float is an “Operator Friendly” mowing feature and can be used singly or in conjunction with lift float.

NOTE: For the feature to work to its maximum capabilities the head must be mounted so that it is balanced within the pivot.

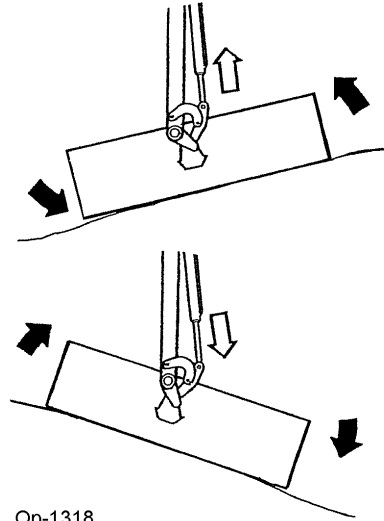

Op-1318

8.2 Engaging the Drive

1. Ensure that the rotor control lever is moved to the “STOP” position before engaging the PTO shaft.
2. Allow the oil to circulate for a minute or so before operating the arm head levers.
3. Position the flail head in a safe position, increase the engine speed to a high idle and move rotor control lever to “ON”.
4. After initial surging the rotor will run at an even speed. Starting the rotor this way reduces the starting loads imposed on the hydraulic motor and the drive splines.

8.3 Rotor Operating Speed

Ensure that the rotor control lever is in ‘STOP’ position before engaging the PTO shaft. Allow the oil to circulate for a minute or so before operating the arm head levers. Position the flail head in a safe position, increase the engine speed to a high idle and move rotor control lever to ‘START’. After initial surging, the rotor will run at an even speed

8.4 Forward Speed

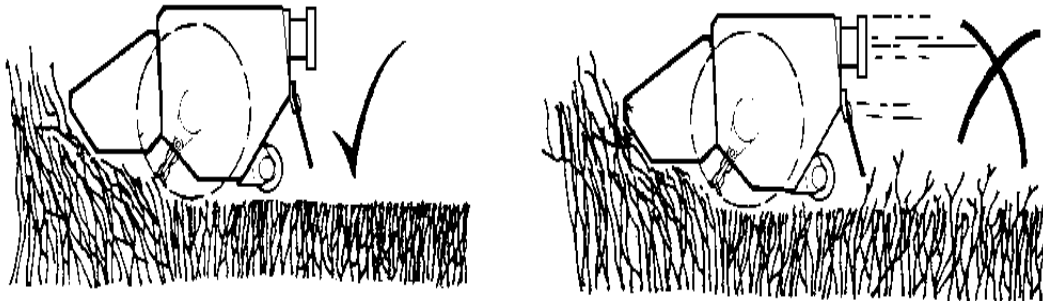

Op-531

Tractor ground speed is determined by the material being cut. Heavier materials require slower speeds or a second pass. Travel speeds that are too fast will cause the engine RPM to drop, will cause the cut material to have a poor finish, or will activate the breakaway system frequently. Do not exceed 2 MPH while operating mower head.

OPERATION

8.5 Tractor Position

The position of the tractor in relation to the hedgerow will again be determined by experience. For a normal straight forward hedgerow the position should be such as to allow the reach cylinder to be in mid-stroke. This effectively allows the reach to be adjusted in either direction without altering the tractor's position.

8.6 Operating Speed

The flail head should be run at a constant speed of 2500 RPM. To achieve these speeds it will be necessary to run the tractor engine to give a PTO speed of 540 RPM.



Never exceed 540 RPM on the PTO shaft.

8.7 Parallel Motion Geometry

This feature enables the operator to adjust the reach of the machine in and out without having to continuously adjust the lift service to compensate for the change in head pivot height.

NOTE: *The performance of the feature is at its most accurate during the mid range of reach, with some deterioration in performance being experienced when the outer extremities of reach adjustment are approached.*

8.8 Working Close In and High

When attempting to position the flail head to cut close in and high the main arm may touch against the stop before the required head position is achieved. If this occurs select "Reach out", this will cause the main arm to lift off the stop allowing the "Lift up" motion to be continued on service selection.

Using this technique allows the flail head to be positioned in the "Close In" position from ground level to full height.

8.9 Breakaway Action

The machine is fitted with a hydraulic breakaway device which protects the structure of the machine should an unforeseen obstacle be encountered.

NOTE: *The breakaway function does not relieve the operator of his responsibility to drive carefully, be alert and AVOID OBVIOUS HAZARDS BEFORE CONTACT OCCURS.*

Breakaway may occur momentarily during normal work should an extra thick or dense patch of vegetation be encountered. In these instances, tractor forward motion may be maintained with care. Where breakaway has occurred as a result of contacting a post, tree, etc., the tractor must be halted and the controls of the machine utilized to maneuver the head away from the obstacle. NEVER CONTINUE FORWARD MOTION TO DRAG THE HEAD AROUND THE OBSTACLE IN BREAKBACK POSITION.

NOTE: *The force required to activate the breakaway system will vary dependent upon the gradient of work. It will require less force when working uphill and vice versa.*

OPERATION

8.10 High Voltage Cables

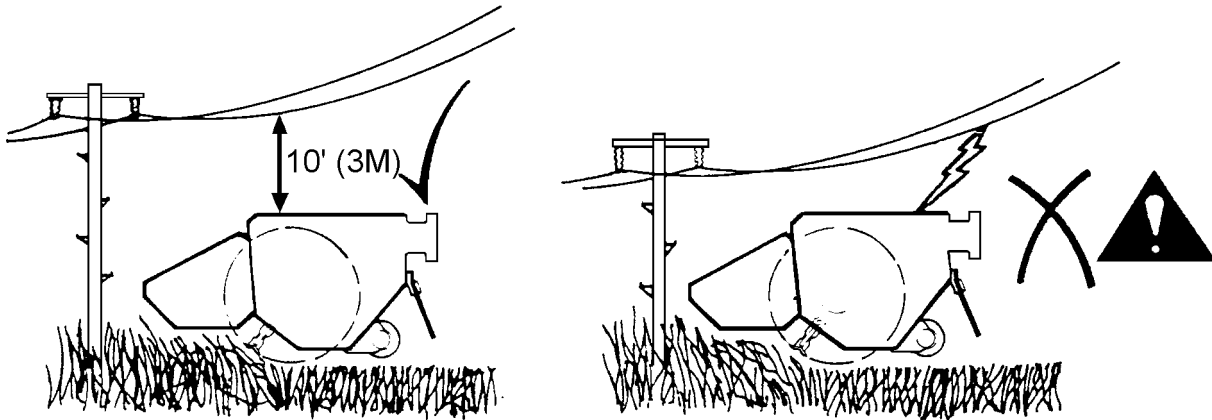

Op-1384

⚠ DANGER

Always keep a careful lookout and use extreme care when working around overhead obstructions. Never allow the mower head or boom within 10 feet of any power line. When working close to overhead power lines consult your electric company for a safe code of operation. (SBM-7W)str

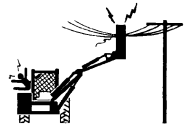

Depending on the voltage of the cables and the weather conditions there is a danger of electric flashover if the head or arms approach the cables too closely.

Always maintain a minimum clearance distance of 10' when operating near high voltage cables.

OPERATION

OPERATION

8.11 Cutting Sequence

OPERATION

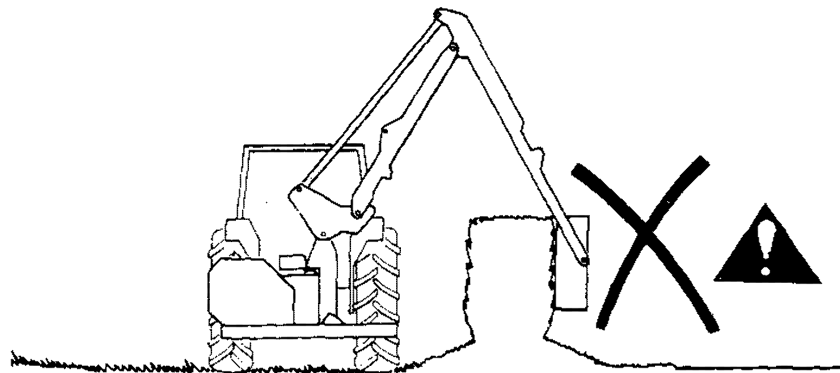
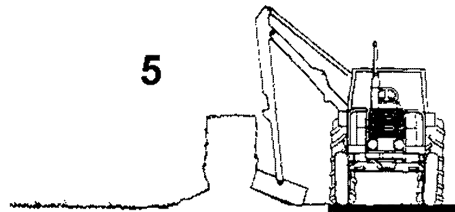
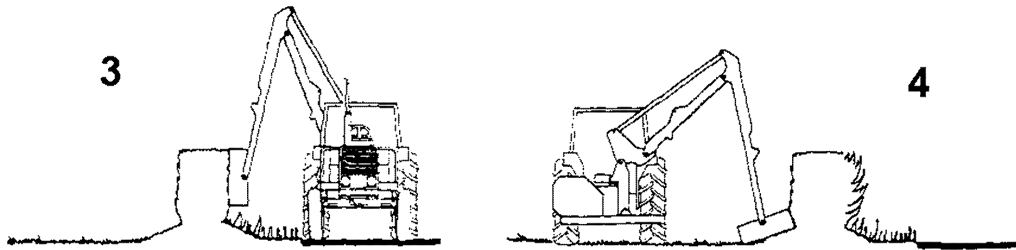
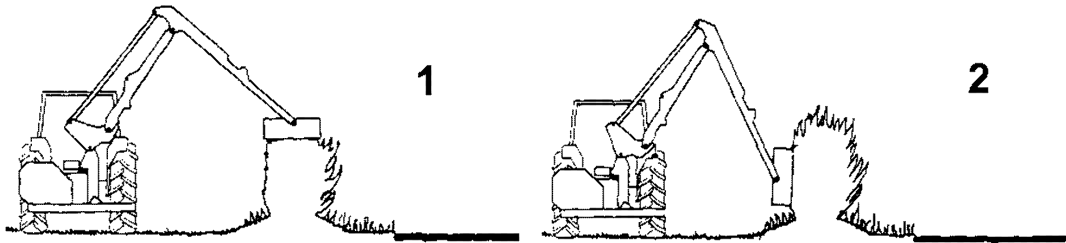

Op-1385

OPERATION

Operator preference will ultimately decide on the order of cutting. Where it is difficult to determine the original hedge line because of overgrowth a recommended method is to start by siding up the hedge first, if necessary making more than one pass.

A second cut should then be taken at an incline along the hedge top and again if there is prolific growth it may be necessary to make more than one pass until the hedge is reduced to the height and contour required.

Finally, finish with a ground cut. The roller should be lowered for this. This ground cut defines the base line of the hedge, severs shrubs and debris that encroach out from the bottom, and further mulches the toppings that have fallen.

NOTE: Flails are more prone to accidental damage and blunting by stones on a ground cut. Therefore, when convenient, this should be left until the end.

Where the hedge has been well maintained in the past, it may be found better to cut the top before either side.

WARNING

Do not be tempted to make a vertical cut on the opposite or "Away from the Tractor" side of the hedge. This would entail cutting "blind" and the rotating flail would be capable of throwing debris through the hedgerow in line with the operator.

Where both sides of a roadside hedge are to be cut, always cut the field side first. The uncut roadside helps to reduce the amount of debris being flung through the hedge onto the road. Also by sloping the vertical cut to give an "A" shape, debris is thrown down into the hedge bottom and the spread of material is reduced.

8.12 Grass Cutting

Flails must cut upwards.

Front hood CW flaps, skids and rear flap must be fitted.

The mounting holes allow three positions for the front hood.

NOTE: For cutterbars 500 RPM is a guide speed only. It should be run only as fast as necessary to do the job. Never exceed 540 RPM PTO speed.

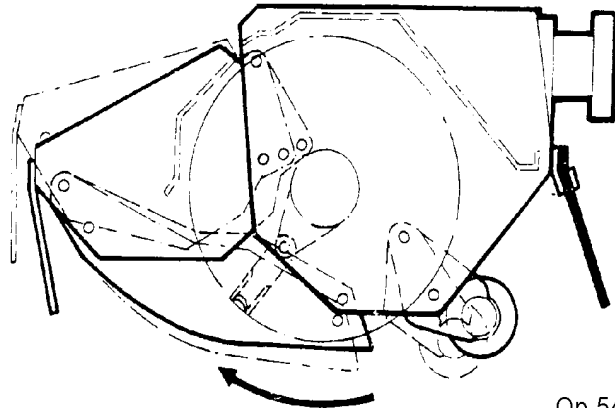

Op-542

OPERATION

9. DRIVING THE TRACTOR AND IMPLEMENT

Safe tractor transport requires the operator to possess a thorough knowledge of the model being operated and precautions to take while driving with an attached implement. Ensure the tractor has the capacity to handle the weight of the boom and the tractor operating controls are set for safe transport. To ensure safety while driving the tractor with a boom, review the following.

Read all safety instructions. Decals on the Boom warn you of particular and multiple hazards. Some decals are attached close to part of the Boom where there is a possible hazard. Read and make sure you understand the safety messages before you operate the implement. Keep all decals clean and readable. Replace lost or damaged decals, refer to safety section for more information.

Power for operating the mower is supplied from the tractor PTO. Refer to your tractor manual instructions for engaging and disengaging the PTO. Start the tractor and bring the engine speed up to normal operating 540 PTO speed. Always engage the PTO at low engine RPM and run the mower for a short period until all air is removed from the hoses. Keep all person's well clear of mower since blades can throw objects with great velocity for a considerable distance! KEEP CLEAR! OPS-B- 0005str



Never operate the Tractor or Implement until you have read and completely understand this Manual, the Tractor Operator's Manual, and each of the Safety Messages found in the Manual or on the Tractor and Implement. Learn how to stop the tractor engine suddenly in an emergency. Never allow inexperienced or untrained personnel to operate the Tractor or Implement without supervision. Make sure the operator has fully read and understood the manuals prior to operation.

(SG-4)str



Always maintain the safety signs in good readable condition. If the safety signs are missing, damaged, or unreadable, obtain and install replacement safety signs immediately. (SG-5)str



This Implement may be wider than the Tractor. Be careful when operating or transporting this equipment to prevent the Implement from running into or striking sign posts, guard rails, concrete abutments or other solid objects. Such an impact could cause the Implement and Tractor to pivot violently resulting in loss of steering control, death, or serious injury. Never allow the Implement to contact obstacles. (S3PT-12)str



BEFORE leaving the tractor seat lower the implement, set the parking brake and/or set the tractor transmission in parking gear, disengage the PTO, stop the engine, remove the key, and wait for all moving parts to stop. Place the tractor shift lever into a low range or parking gear to prevent the tractor from rolling. Never dismount a Tractor that is moving or while the engine is running. Operate the Tractor controls from the tractor seat only.

(SG-9)str

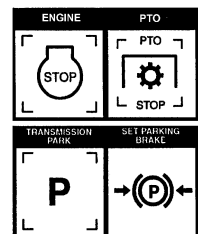

OPERATION

WARNING

Transport only at speeds where you can maintain control of the equipment. Serious accidents and injuries can result from operating this equipment at high speeds. Understand the Tractor and Implement and how it handles before transporting on streets and highways. Make sure the Tractor steering and brakes are in good condition and operate properly.



Before transporting the Tractor and Implement, determine the proper transport speeds for you and the equipment. Make sure you abide by the following rules:

Test the tractor at a slow speed and increase the speed slowly. Apply the Brakes smoothly to determine the stopping characteristics of the Tractor and Implement. As you increase the speed of the Tractor the stopping distance increases. Determine the maximum transport speed not to exceed 20 mph (30 kph) for transporting this equipment.

Test the equipment at a slow speed in turns. Increase the speed through the turn only after you determine that the equipment can be operated at a higher speed. Use extreme care and reduce your speed when turning sharply to prevent the tractor and implement from turning over. Determine the maximum turning speed for you and this equipment before operating on roads or uneven ground.

Only transport the Tractor and Implement at the speeds which allow you to properly control the equipment.

Be aware of the operating conditions. Do not operate the Tractor with weak or faulty brakes or worn tires. When operating down a hill or on wet or rain slick roads, the braking distance increases: use extreme care and reduce your speed. When operating in traffic always use the Tractor's flashing warning lights and reduce your speed. Be aware of traffic around you and watch out for the other guy. (SG-19)str



OPERATION

9.1 Starting the Tractor

The procedure to start the tractor is model specific. Refer to the tractor operator's manual for starting procedures for your particular tractor. Consult an authorized dealer if the starting procedure is unclear. Ensure the 3-point control lever is in the lowered position and the PTO is disengaged before starting the tractor. OPS-U-0033str



OPERATION

9.2 Brake and Differential Setting

Make sure the tractor brakes are in good operating condition. Tractor brakes can be set to operate independently allowing single rear wheel braking action or locked together to provide simultaneous rear wheel braking. FOR MOST DRIVING AND OPERATING CONDITIONS, THE BRAKE PEDALS SHOULD BE LOCKED TOGETHER TO PROVIDE THE MOST EFFECTIVE BRAKING ACTION.

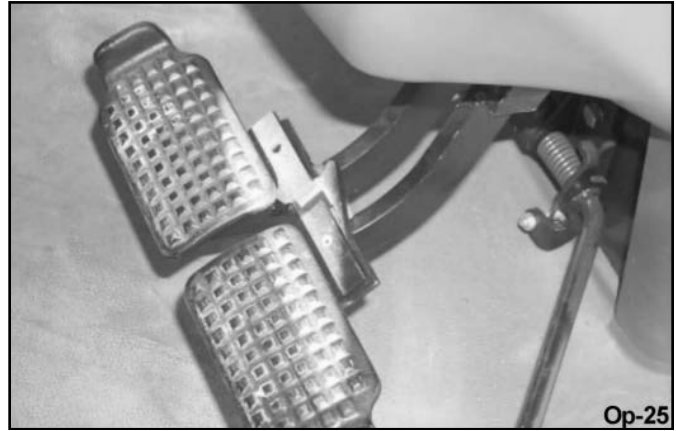

Always disengage the tractor differential lock when turning. When engaged the differential lock will prevent or limit the tractor from turning. During normal cutting conditions, locking the differential provides no benefit and should not be used.



Be aware of the operating conditions. Do not operate the Tractor with weak or faulty brakes. When operating down a hill or on wet or rain slick roads, the braking distance increases. Use extreme care and reduce your speed in these conditions. When operating in traffic, always use the Tractor's flashing warning lights and reduce your speed. Be aware of traffic around you and watch out for the other guy. *OPS-U- 0013 str*



Use extreme caution when raising the Mower head. Stop the Blades from turning when the Mower Head is raised and passersby are within 300 feet. Raising the Mower head exposes the Cutting Blades which creates a potentially serious hazard and can cause serious injury by objects thrown from the Blades or by contact with the Blades. *(SBM-2) str*



Never leave the mower unattended while the head is in the raised position. The mower could fall causing serious injury to anyone who might inadvertently be under the mower. *(SBM-4str)*



Do not put hands or feet under mower decks. Blade Contact can result in serious injury or even death. Stay away until all motion has stopped and the decks are securely blocked up. *(SFL-2) str*



Make certain that the Boom swing path is clear of bystanders, powerlines, and obstructions to prevent injury, electrocution, and possible machine damage. Swing Boom SLOWLY AND CAREFULLY. Avoid sudden starting and stopping. *(Ops-0002-MISC)str*

OPERATION

9.3 Driving the Tractor and Boom

Start off driving at a slow speed and gradually increase your speed while maintaining complete control of the tractor. Never operate the tractor at speeds that cannot be safely handled or which will prevent the operator from stopping quickly during an emergency. If the power steering or engine ceases operating, stop the tractor immediately as the tractor will be difficult to control.

Perform turns with the tractor and mower at slow speeds to determine how the tractor with an attached implement handles a turn. Determine the safe speed to maintain proper control of the tractor when making turns. When turning with the implement the overall working length and width of the unit is increased. Allow additional clearance for the unit when turning or when passing large obstructions.

To avoid overturns, drive the tractor with care and at safe speeds, especially when operating over rough ground, crossing ditches or slopes, and turning corners. Use extreme caution when operating on steep slopes. Keep the tractor in a low gear when going downhill. DO NOT coast or free-wheel downhill. OPS-B- 0006_G str



Never leave the mower unattended while the head is in the raised position. The mower could fall causing serious injury to anyone who might inadvertently be under the mower. (SBM-4str)



Always keep a careful lookout and use extreme care when working around overhead obstructions. Never allow the mower head or boom within 10 feet of any power line. When working close to overhead power lines consult your electric company for a safe code of operation. (SBM-7W)str

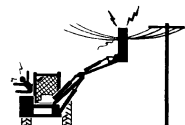

10. OPERATING THE TRACTOR AND IMPLEMENT

THE OPERATOR MUST COMPLETELY UNDERSTAND HOW TO OPERATE THE TRACTOR AND IMPLEMENT AND ALL CONTROLS BEFORE ATTEMPTING TO OPERATE.

The operator must read and understand the Safety and Operation Sections of the implement and tractor operator's manuals. These manuals must be read and explained to any operator who cannot read. Never allow someone to operate the implement and tractor without complete operating instructions.

Before starting any operation, the operator must become familiar with the area to be worked in and any obstacles and hazards contained within to ensure safety to the operator, bystanders, and equipment. Special attention should be paid to foreign debris, rough terrain, steep slopes, and passersby and animals in the area. OPS-U- 0015 str



Extreme care should be taken when operating near loose objects such as gravel, rocks, wire, and other debris. Inspect the area before mowing. Foreign objects should be removed from the site to prevent machine damage and/or bodily injury or even death. Any objects that cannot be removed must be clearly marked and carefully avoided by the operator. Stop mowing immediately if blades strike a foreign object. Repair all damage and make certain rotor or blade carrier is balanced before resuming mowing. (SGM-05)str

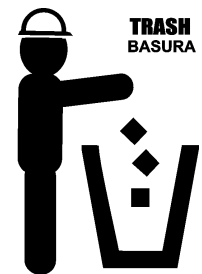

OPERATION

11. OPERATING INSTRUCTIONS

1. Engage the PTO shaft at low engine RPM and speed the engine up after blades are fully engaged. Never engage the PTO shaft at a high engine RPM. This could cause damage to the PTO shaft as well as the Speed Increaser and Pump. Always operate PTO at the recommended RPM when mowing. This is necessary to maintain proper blade speed and to produce a clean cut.
2. Proper ground speed for cutting will depend upon the height, type, and density of material to be cut. Maintain ground speed of 2 m.p.h. Tall dense material should be cut at low speed while thin medium height material can be cut at a faster ground speed.
3. Always run the Mower at the highest position which will enable you to obtain the desired cutting results. Allowing the blades to cut into the ground will cause wear and undue strain on the mower frame and mower components.

If you are mowing in conditions of heavy growth or rough ground where the blades cut into the ground and the tractor engine slows down, do not slip the clutch to allow the engine to speed up and engage the clutch again

This procedure exerts tremendous strain on Mower components. Always disengage the PTO and move forward or backwards until the machine is clear.

This mower is designed with free swinging blades. This feature reduces the amount of shock transmitted to other components. Always make sure the blades can swing freely on the blade bar.

Do not ride the clutch on the tractor. Mow in the appropriate gears to give the correct ground speed.

Extremely tall grass should be cut twice. Raise mower and cut twice the desired height. Cut the second time at desired height at 90 degrees to first pass

Remember, sharp blades produce cleaner cuts and use less power.

Before cutting, analyze the area to determine the best cutting procedure. Consider the height and type of material and the terrain type: hilly, level or rough.



WARNING Do not mow with two machines in the same area except with Cab tractors with the windows closed. (SGM-11)str



WARNING Mow only in conditions where you have clear visibility in daylight or with adequate artificial lighting. Never mow in darkness or foggy conditions where you cannot clearly see at least 100 feet (30 m) in front and to the sides of the tractor and mower. Make sure that you can clearly see and identify passersby, steep slopes, ditches, drop-offs, overhead obstructions, power lines, debris and foreign objects. If you are unable to clearly see these types of items discontinue mowing. (SGM-1) str



WARNING Avoid mowing in reverse direction when possible. Check to make sure there are no persons behind the mower and use extreme care when maneuvering in reverse. Mow only at a slow ground speed where you can safely operate and control the tractor and mower. Never mow an area that you have not inspected and removed debris or foreign material. (SGM-08) str



WARNING Never operate the mower head tilted down where the operator can see the blades of the mower. The blade could throw an object toward the operator causing serious injury or death. Never operate the mower without an Operator Protective Structure. Always wear safety glasses and a hard hat. (Ops-0005-MISC str)

OPERATION

⚠️ WARNING

Many varied objects, such as wire, cable, rope, or chains, can become entangled in the operating parts of the mower head. These items could then swing outside the housing at greater velocities than the blades. Such a situation is extremely hazardous and could result in serious injury or even death. Inspect the cutting area for such objects before mowing. Remove any like object from the site. Never allow the cutting blades to contact such items.

(SGM-06) str

11.1 Foreign Debris Hazards

Before mowing, inspect the area to make sure there are no foreign objects that the mower blades could hit or become entangled with. Remove all foreign objects and debris. If objects are too big to remove, mark them clearly and be sure to prevent the mower blades from contacting them.

If you hit a solid object or foreign debris, stop the mower and tractor at once. Immediately idle the engine speed and disengage the PTO. Wait for all mower rotating motion to stop, then raise the mower and move the tractor and implement off the object. Inspect the area and remove, or mark the location of the debris. Inspect the condition of the mower and make any needed repairs immediately. Make sure the blades are not damaged and the carrier is balanced before resuming operation.

Always wear your seat belt securely fastened and only operate the tractor and mower with the ROPS in the raised position. If the tractor or mower hits a tree stump, rock, or bump, a sudden movement could throw you off of the seat and under the tractor and/or mower. The seat belt is your best protection from falling off the tractor and the ROPS provides protection from being crushed during a tractor roll-over. *OPS-F-0010 str*



OPERATION

11.2 Bystanders/Passersby Precautions

If a bystander comes within 300 feet of the tractor while the mower is being operated, stop the tractor at once, idle the engine and disengage the PTO. Do not engage the PTO again until all bystanders are well past the 300 foot distance. OPS-R-0024 str



DANGER

Flail Mowers are capable under adverse conditions of throwing objects for great distances (300 feet or more) and causing serious injury or death. Follow safety messages carefully.



STOP MOWING IF PASSERSBY ARE WITHIN 300 FEET UNLESS:

- Front and Rear Deflectors, Chain Guards, or Bands are installed and in good, workable condition;
- Mower sections or Wings are running close to and parallel to the ground without exposed Blades;
- All areas have been thoroughly inspected and all foreign material such as rocks, cans, glass, and general debris has been removed.

NOTE: Where there are grass and weeds high enough to hide debris that could be struck by the blades, the area should be: inspected and large debris removed, mowed at an intermediate height, inspected closely with any remaining debris being removed, and mowed again at desired final height. (This will also reduce power required to mow, reduce wear and tear on the Mower drivetrain, spread cut material better, eliminate streaking, and make the final cut more uniform). (SFL-6) str

11.3 Engaging the Power Take Off (PTO)

Before engaging the PTO, make certain that the area is clear of bystanders and passersby. The implement must be completely lowered and the deck positioned at a safe operating height. NEVER engage the PTO with the implement in the raised position.

Set the tractor engine speed at approximately 1,000 RPM before engaging the PTO. Shift the PTO control to the on position, and slowly increase the engine speed until the PTO is operating at the rated speed. If you hear unusual noises or see or feel abnormal vibrations, disengage the PTO immediately. Inspect the implement to determine the cause of the noise or vibration and repair the abnormality. OPS-U- 0027 str



WARNING

Do not put hands or feet under mower decks. Blade Contact can result in death or serious injury. Stay away until all motion has stopped and the decks are securely blocked up. (SGM-09) str

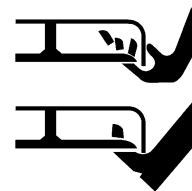

OPERATION

11.4 Operating Speed and Ground Speed

Ground speed for mowing will depend upon the height, type, and density of vegetation to be cut. Do Not exceed 2 MPH while operating. Operate the mower at its full rated PTO speed to maintain blade speed for a clean cut. Refer to the tractor operator's manual or the tractor instrument panel for the engine speed and gear to provide the required operating and desired ground speed. Make sure that the mower is operating at its full rated speed before entering the vegetation to be cut. Always start and stop cutting blades with engine near idle.

Ground speed is achieved by transmission gear selection and not by the engine operating speed. The operator may be required to experiment with several gear range combinations to determine the best gear and range which provides the most ideal performance from the implement and most efficient tractor operation. As the severity of cutting conditions increase, the ground speed should be decreased by selecting a lower gear to maintain the proper operating PTO speed. *OPS-B- 0009str*



WARNING

Do not exceed the rated PTO speed for the Implement. Excessive PTO speeds can cause Implement driveline or component failures resulting in serious injury or death. *(SG-26) str*



WARNING

Mow at the speed that you can safely operate and control the tractor and mower. The correct mowing speed depends on terrain condition and grass type, density, and height of cut. Normal ground speed range is from 2 to 5 mph (3-8 kph). Use slow mowing speeds when operating on or near steep slopes, ditches, drop-offs, overhead obstructions, power lines, or when debris and foreign objects are to be avoided. *(SGM-07)str*

11.5 Operating the Mower

The mower is designed to cut vegetation of various diameters depending on the attachment (see the following pages). Sharp blades will produce a cleaner cut and require less power. Travel at a speed that allows the mower sufficient time to cut through the vegetation and maintain the PTO operating speed to prevent overloading the mower and tractor. Choose a driving pattern that provides the maximum pass length and minimizes turning.

Under certain conditions, tractor tires may roll some grasses down preventing them from being cut at the same height as the surrounding area. When this occurs, reduce the tractor ground speed while maintaining the operating speed of the mower. A slower ground speed will permit grasses to at least partially rebound and be cut. Taking a partial cut and/or reversing the direction of travel may also help produce a cleaner cut.

Avoid mowing in the reverse direction when possible. In situations where the mower must be backed to access areas to be cut, make sure there are no persons or other foreign debris behind the mower before mowing in reverse. When mowing in reverse, operate the tractor and mower at a reduced ground speed to ensure tractor and mower control is maintained. *OPS-R-0026_S str*



DANGER

There are obvious and hidden potential hazards in the operation of this Mower. REMEMBER! This machine is often operated in heavy brush and in heavy weeds. The Blades of this Mower can throw objects if shields are not properly installed and maintained. Serious injury or even death may occur unless care is taken to ensure the safety of the operator, bystanders, or passersby in the area. Do not operate this machine with anyone in the immediate area. Stop mowing if anyone is within 300 feet of mower. *(SGM-02)str*



WARNING

Do not mow with two machines in the same area except with Cab tractors with the windows closed. *(SGM-11)str*

OPERATION

⚠ WARNING

Mow only in conditions where you have clear visibility in daylight or with adequate artificial lighting. Never mow in darkness or foggy conditions where you cannot clearly see at least 100 feet (30 m) in front and to the sides of the tractor and mower. Make sure that you can clearly see and identify passersby, steep slopes, ditches, drop-offs, overhead obstructions, power lines, debris and foreign objects. If you are unable to clearly see these types of items discontinue mowing. (SGM-1) str

⚠ WARNING

Avoid mowing in reverse direction when possible. Check to make sure there are no persons behind the mower and use extreme care when maneuvering in reverse. Mow only at a slow ground speed where you can safely operate and control the tractor and mower. Never mow an area that you have not inspected and removed debris or foreign material. (SGM-08) str

⚠ WARNING

Follow these guidelines to reduce the risk of equipment and grass fires while operating, servicing, and repairing the Mower and Tractor:



- Equip the Tractor with a fire extinguisher in an accessible location.
- Do Not operate the Mower on a Tractor with an under-frame exhaust.
- Do Not smoke or have an open flame near the Mower and Tractor.
- Do Not drive into burning debris or freshly burnt areas.
- Ensure slip clutches are properly adjusted to prevent excessive slippage and plate heating.
- Never allow clippings or debris to collect near drivelines, slip clutches, and gear-boxes. Periodically shut down the Tractor and Mower and clean clippings and collected debris from the mower deck. (SGM-12) str

OPERATION

11.6 Operating the Attached Mower Heads

Refer to the Assembly Section of this manual to ensure the head is properly attached to the boom hitch and hydraulic lines are properly connected.



There are obvious and hidden potential hazards in the operation of this Mower. REMEMBER! This machine is often operated in heavy brush and in heavy weeds. The Blades of this Mower can throw objects if shields are not properly installed and maintained. Serious injury or even death may occur unless care is taken to ensure the safety of the operator, bystanders, or passersby in the area. Do not operate this machine with anyone in the immediate area. Stop mowing if anyone is within 300 feet of mower. (SGM-

02)str



GRASS FLAIL

- The Grass Flail head is rated for cutting grass and small brush up to 1”.
- The Grass Flail operates attached to the boom arm, and is ideal for cutting hard to reach areas where a smooth cut is required.
- Cutting height ranges from 3/4” to 4” in vegetation. Cutting height is set by adjusting the height of the roller assembly.
- When operating near the ground or when mulching be particularly careful that there are no bystanders or animals within 300 feet. Debris tends to fly out at great speed and can injure or even cause death. *OPS-B- 0040_C str*

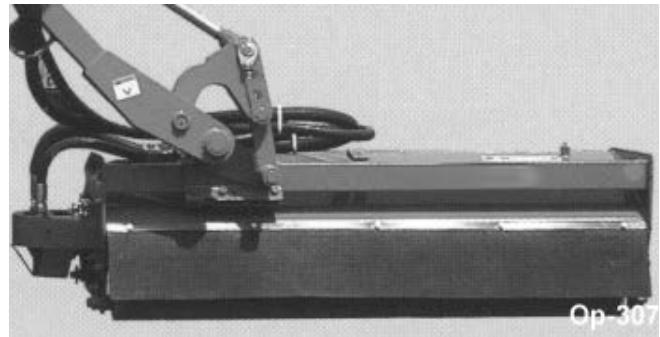

SICKLEBAR

- The Sicklebar Cutter will cut a 5' swath through tough weeds and grass up to 1-1/4”.
- The Sicklebar Cutter is operated attached to the boom arm and is ideal for vegetation maintenance.
- When operating the Sicklebar correctly it will give you a fast, efficient, and cost-effective method of vegetation maintenance.
- The Sicklebar will also cut vegetation through tough weeds under water, ideal for maintaining ponds, creeks, and other areas that may be under shallow water.
- When operating the unit be sure there are no bystanders or animals within 300 feet of the unit. *OPS-B- 0049_A str*



OPERATION

11.7 Shutting Down the Attached Head

To shut down attached mower head, first bring the tractor to a complete stop. Decrease engine RPM to idle then disengage cutterhead. The mower head will come to a complete stop within a suitable amount of time. Do not engage or disengage the cutterheads at a high RPM unless there is an emergency situation.

Park the tractor on a level surface, place the transmission in park or neutral and apply the parking brake, shut down the engine, remove the key, and wait for all motion to come to a complete stop before exiting the tractor. OPS-B- 0011_J



BEFORE leaving the tractor seat lower the implement, set the parking brake and/or set the tractor transmission in parking gear, disengage the PTO, stop the engine, remove the key, and wait for all moving parts to stop. Place the tractor shift lever into a low range or parking gear to prevent the tractor from rolling. Never dismount a Tractor that is moving or while the engine is running. Operate the Tractor controls from the tractor seat only.

(SG-9)str

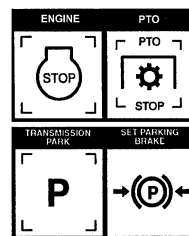

12. TRACTOR, BOOM, AND ATTACHED HEAD STORAGE

Properly preparing and storing the unit at the end of the season is critical to maintaining its appearance and to help ensure years of dependable service. The following are suggested storage procedures:

- Thoroughly clean all debris from boom and head to prevent damage from rotting grass and standing water.
- Lubricate all grease points and fill oil levels according to the maintenance lubrication schedule.
- Tighten all bolts to the proper torque. Ensure all pins and other hardware are in place.
- Check the boom arm and head for worn and damaged parts. Perform repairs and make replacements so that the mower will be ready for use at the start of the next season.
- Store the unit in a clean and dry location.
- Use spray touch-up enamel where necessary on bare metal surfaces to prevent rust and to maintain the appearance of the mower. OPS-B- 0012_G str



OPERATION



Never allow children to play on or around Tractor or Implement. Children can slip or fall off the Equipment and be killed or injured. Inadvertent contact with controls can cause the Implement to shift or fall crushing themselves or others. (SG-25) str



BEFORE leaving the tractor seat lower the implement, set the parking brake and/or set the tractor transmission in parking gear, disengage the PTO, stop the engine, remove the key, and wait for all moving parts to stop. Place the tractor shift lever into a low range or parking gear to prevent the tractor from rolling. Never dismount a Tractor that is moving or while the engine is running. Operate the Tractor controls from the tractor seat only.

(SG-9)str

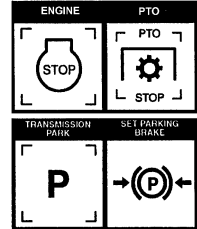

Always shut the Tractor completely down, place the transmission in park, and set the parking brake before you or anyone else attempts to connect or disconnect the Implement and Tractor hitches. (S3PT-15) str



Never allow children to play on or around Tractor or Implement. Children can slip or fall off the Equipment and be killed or injured. Inadvertent contact with controls can cause the Implement to shift or fall crushing themselves or others. (SG-25) str

OPERATION

13. TRANSPORTING THE TRACTOR AND IMPLEMENT

Inherent hazards of operating the tractor and implement and the possibility of accidents are not left behind when you finish working in an area. Therefore, the operator must employ good judgment and safe operation practices when transporting the tractor and implement between locations. By using good judgment and following safe transport procedures, the possibility of accidents while moving between locations can be substantially minimized. OPS-U- 0017str



Never allow children or other persons to ride on the Tractor or Implement. Falling off can result in death or serious injury. (SG-10)str



Before transporting the tractor on a public roadway or boarding a trailer for transport, the tractor brake pedals should be locked together. Locking the pedals ensures that both wheels brake simultaneously while stopping, especially when making an emergency stop.

Use extreme caution and avoid hard applications of the tractor brakes when towing heavy loads at road speeds. Never tow the implement at speeds greater than 20 MPH (32 kph). OPS-U- 0018 str



OPERATION

13.1 Transporting on Public Roadways

Extreme caution should be used when transporting the tractor and implement on public roadways. The tractor must be equipped with all required safety warning features including a SMV emblem and flashing warning lights to alert drivers of the tractor's presence. Remember that roadways are primarily designed for automotive drivers and most drivers will not be looking out for you, therefore, you must look out for them. Check your side view mirrors frequently and remember that vehicles will approach quickly because of the tractor's slower speed. Be extremely cautious when the piece of equipment that you are towing is wider than the tractor tire width and/or extends beyond your lane of the road.

Make sure that a proper size safety tow chain is secured between the tractor and implement before entering a public road. *OPS-U- 0019 str*

NOTE: Ensure that the mower sections are fully raised and that the transport locks are engaged for each section.



Only tow the Implement behind a properly sized and equipped Tractor which exceeds the weight of the Implement by at least 20%. DO NOT tow the Implement behind a truck or other type of vehicle. Never tow the Implement and another Implement connected in tandem. Never tow the Implement at speeds over 20 MPH. *(STI-06)str*



Never allow children or other persons to ride on the Tractor or Implement. Falling off can result in death or serious injury. *(SG-10)str*



Make certain that the "Slow Moving Vehicle" (SMV) sign is installed in such a way as to be clearly visible and legible. When transporting the Equipment use the Tractor flashing warning lights and follow all local traffic regulations. *(SG-6)str*

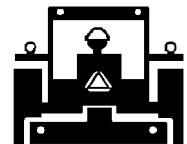

The SMV (Slow-Moving Vehicle) emblem is universal symbol used to alert drivers of the presence of equipment traveling on roadways at a slow speed. SMV signs are a triangular bright orange with reflective red trim for both easy day and night visibility. Make sure the SMV sign is clean and visible from the rear of the unit before transporting the tractor and implement on a public roadway. Replace the SMV emblem if faded, damaged, or no longer reflective. *OPS-U- 0020str*



Op-43

OPERATION

Make sure that all of the tractor's flashing warning lights, headlights, and brake/taillights are functioning properly before proceeding onto public roads. While newer model tractors have plenty of lighting to provide warning signals and operating lighting, most older models have only been equipped with operating lights. Consult an authorized tractor dealer for lighting kits and modifications available to upgrade the lighting on older tractor models. *OPS-B-0015str*



When operating on public roads, have consideration for other road users. Pull to the side of the road occasionally to allow all following traffic to pass. Do not exceed the legal speed limit set in your state or municipality for agricultural tractors. Always stay alert when transporting the tractor and mower on public roads. Especially in busy cities, the boom extends to right farther than the tractors width, so be careful there are no bystanders, poles, large obstructions or any vehicles that may be in path of the mower head or boom. Use caution and reduce speed if other vehicles or pedestrians are in the area. *OPS-B-0016str*



Reduce speed before turning or applying the brakes. Ensure that both brake pedals are locked together when operating on public roads. *OPS-U-0023 str*



⚠ DANGER

When transporting Boom Mower on a truck or trailer, the height or width may exceed legal limits when the boom is in the transport position. Contact with side or overhead structures or power lines can cause property damage or serious injury or death. If necessary lower boom to reduce height and/or remove mowing head to reduce width to the legal limits (SBM-8)str

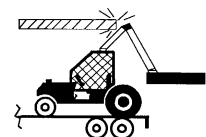

OPERATION

13.2 Hauling the Tractor and Implement

Before transporting a loaded tractor and implement, measure the height and width dimensions and gross weight of the complete loaded unit. Ensure that the load will be in compliance with the legal limits set for the areas that will be traveled through. *OPS-U- 0024_TKstr*



Use adequately sized and rated trailers and equipment to transport the tractor and implement. Consult an authorized dealer to determine the proper equipment required. Using adequately sized chains, heavy duty straps, cables and/or binders, securely tie down both the front and rear of the tractor utilizing the proper tie down locations as specified by the tractor manufacturer. *OPS-U- 0025 str*



Arrange the chains so that when tightened, the chains are pulling downward and against themselves. Carefully tighten the securing chains or other fasteners using boomers or binders to apply maximum tension. Use extreme care when attaching and removing the securing devices as the extreme tension involved when released has the potential to inflict serious injury.

While hauling the tractor and implement, make occasional stops to check that the tractor and implement have not moved or shifted and that the securing chains have maintained tension. If during transport a hard braking, sharp turning, or swerving action was performed, stop at the next safe location to inspect the security of the load.



NOTE: Always transport per your State and Federal law regulations for tie down requirements. *OPS-U- 0026_TKstr*

OPERATION

14. TROUBLESHOOTING GUIDE

Problem	Possible Cause	Remedy
Boom Breaks Back Too Easily	Work port relief malfunction or failure.	Test to confirm, adjust or replace as needed.
	Swing cylinder failure.	Test to confirm, rebuild or replace as needed.
	Cutting head “plowing” in ground.	Operator error, operator training.
	Operator traveling too fast.	Operator error, operator training.
Boom Drops When Two Functions Actuated	Low oil level on boom function system.	Fill oil and bleed system of air.
	Failed one-way flow restrictor in valve.	(Gravity aided functions only). Confirm and replace.
	Defective or damaged controller.	Repair or replace as needed.
	Incorrect hose size to cylinder(s).	Replace with proper OEM part.
	Defective or damaged joystick controller.	Repair or replace as required.
Boom Moves on its Own (Under power w/ no function actuated) Electronic Joystick Models	Solenoid valves stuck due to contamination.	Repair or replace as required. Flush and fill hydraulic system.
	Failed o-ring on solenoid valves.	Replace o-ring with proper replacement part.
	Improper wiring.	Confirm and repair.
	Defective or damaged control module(s).	Replace the modules.
	Defective or damaged joystick.	Repair or replace as required.
Boom Moves on Its Own (Under power w/ no function actuated) Mechanical Joysticks w/ Cables	Connection at valve damaged or failed.	Repair or replace as required
	Solenoid valves stuck due to contamination.	Repair or replace as required. Flush and fill hydraulic system.
Cylinder Excessive Drift	May be normal operation.	Check allowable drift rates in Service Manual.
	Cylinder piston seals bypass.	Test to confirm and repair or replace.
	Damaged or defective work port relief valves.	Check relief pressures, Repair or replace as required.
	Oil contamination.	May be root cause of any internal leakage. Test oil and replace as required.
	Related to issues described in previous section. Boom moves under its own power.	Review previous section.

OPERATION

OPERATION

Problem	Possible Cause	Remedy
Cylinder Leaks at Fittings	Loose fittings.	Check for cracks and retighten.
	Wrong fittings installed.	Replace with correct fittings.
	Damaged or defective fitting (cracked).	Due to over tightening. Replace hose or fitting.
	Fitting port cracked.	Repair or replace cylinder or port.
Cylinder Leaks at Rod	Faulty seals on cylinder gland.	Disassemble and replace.
	Damaged cylinder rods.	Clean or replace rod as required.
	Cylinder rods bent.	Determine cause of overload. Replace the rod.
Cylinder Moves Wrong Way (not the function that was actuated)	Incorrect hose routing.	Check hose diagram in the Service Manual and route the hoses correctly.
	Wire harness improperly installed.	Confirm incorrect placement and re-attach the harness connectors as needed.
	Operator perception of correct operation is incorrect.	Consult the Operator's Manual for correct operation and communicate with the operator.
Cylinder Moves Intermittent (all functions)	Cylinder control pump failure (all functions affected)	Test pump to confirm. Rebuild or replace as required.
	Load sense signal not reaching the pump.	Check valve pilot pressure and load sense valves.
	Low or improper oil in hydraulic system.	Replace or fill as required.
	Contamination of oil causing restricted flow in the valve.	Replace oil, and clean components.
	No voltage to joystick controller.	Check fuses, wires, etc. and repair as required.
	Faulty joystick controller.	Test then replace or repair as required.
Cylinder Movement Spongy or Jerky	Air in oil.	Identify the source of the air. Replace oil if required, or cycle the cylinder several times to purge the oil.
	Wrong oil used.	Check specifications for proper oil, and replace.
	Oil is cold.	System must be warmed to at least 40° F for proper operation.
	Faulty pump or pump drive.	Check or test then replace or repair as required.
	Work port reliefs set too low.	Test relief pressure and replace with proper work port relief valve.

OPERATION

Problem	Possible Cause	Remedy
Cylinder Moves Some Functions (But not all)	Faulty joystick controller.	Test the joystick and repair or replace as required.
	Oil level too low.	Fill the hydraulic tank as required.
	Faulty solenoid valve.	Test and repair or replace as required.
	Contamination in valve.	Flush system and clean the valve as required.
	Bad control module.	Replace the module.
	Incorrect work port relief installed.	Check for proper hose routing in the service manual and correctly install.
	Work Port relief failure.	Test work port relief pressure and replace if required.
	Cylinder Failure.	Test cylinder, repair or replace as needed.
	One way flow restrictor installed in wrong port, or backwards.	Check proper installation in service manual. One way flow restrictors are required on most gravity aided functions and both directions of the swing functions.
	Pump worn out. Air in oil.	Test to confirm, repair or replace as required. Locate the source of the air and repair. Flush and fill oil as required.
	Engine RPM too slow.	2000 RPM is the rated speed as indicated on the tachometer.
Cylinder Rod Bent	Operator abuse.	Operator training. Travel speed too fast, or impact with solid objects while mowing.
	Misalignment of cylinder lugs (bent boom).	Operator training, Excessive loading of boom components.
	Work port relief improper interference with another component.	Check for proper setting. Replace as needed. Operator training or components interfering with boom movement.
Cylinder Rod Came Out of Cylinder	Piston nut backed off of the rod.	Improper retaining of nut, replace or rebuild as required.
	Relief valve setting too high.	Test relief valve and adjust or replace as required.
	Operator abuse.	Overloading cylinder in the extend position.
Deck Cracks	Severe use or abuse.	Excessive ground speed, overload or impact with solid objects.
	Vibration.	Blades or blade bar bent, or blade missing.
	Poor or missing welds.	Manufacturing defect.
	Mowing over sand or rocks.	Operator training.

OPERATION

OPERATION

Problem	Possible Cause	Remedy
Deck Worn On Underside (Cutting Head Only)	Abusive operation, mowing heavy debris.	Operator training.
	Normal operational wear.	Normal wear over time can result in cracks or damage. Check deflectors and guards. Replace as required.
Hydraulic System Noise (Squeal)	Restrictions to oil flow in the system.	Identified by concentration of heat, due to line restriction bent hoses or contamination.
	Relief valve malfunction.	Relief setting too low, will result in generation of heat. Adjust or replace as needed.
	Cavitation.	Induction of air into the system due to leakage.
	Wrong oil used.	Flush and refill as required.
	Excessive engine RPM.	Engine RPM should not exceed 2000 speed as indicated on the tractor tachometer.
Hydraulic System Overheating	Restriction in hydraulic system.	Identified by a concentration of heat due to crimped hydraulic line, relief valve failure or contamination.
	Relief valve set too low.	Test and adjust or replace as required.
	Internal leakage due to wear.	Test pump and motor. Replace or repair as required.
	Excessive pump or motor wear.	Test pump and motor. Replace or repair as required.
	Wrong oil.	Flush and refill as required with proper oil.
	Abusive operation (heavy material or debris).	Operator training.
Boom Breaks Back Too Easily	Cutting head "plowing" in ground.	Operator error, operator training.
	Operator traveling too fast.	Operator error, operator training.
Motor Inoperative (Won't Run)	Low oil level or no oil.	Fill or replace as required.
	Improper oil used.	flush and replace the oil.
	Solenoid valve failure or o-ring failure at the solenoid valve.	Remove the solenoid valve and inspect. Replace as required
	No voltage to solenoid valve.	Check harness connections, fuses and wires.
	Solenoid valve.	Timbercat harness plug used in place of other mower plug. Reconnect with proper plug.
	Spindle locked up.	Check by spinning blades. See section on spindle failures

OPERATION

Problem	Possible Cause	Remedy
Motor Overheating	Oil level too low.	Fill or replace as required
	Incorrect oil used.	Flush and fill as required
	Air in oil.	Locate the source and repair. Flush and fill the oil as required.
	Engine RPM too high.	Tractor must be operated at the 540 PTO speed as indicated on the tachometer.
	Excessive ground speed for mowing conditions.	Operator abuse.
	Excessive ground contact with blades.	Operator abuse.
	Internal leakage in pump or motor.	Test to confirm. Repair or replace as required.
	Relief valve malfunction.	Test relief valve setting. Adjust or replace as required.
	Restrictions in the system.	Identified by concentration of heat, due to line restriction bent hoses or contamination.
Motor Shaft Seal Leaking	Excessive back pressure on return side of the motor.	Due to bent fittings or crimped hoses. Inspect the system and repair as required.
	Incorrect oil used.	Replace with correct oil. Flush and fill.
	Shaft seal worn.	Due to heat from the spindle or failure of spindle components. Check spindle section.
	Failed seal retainer.	Manufacturing defect. Consult customer service for proper repair or replacement.
	Defective motor flange casting.	Manufacturing defect. Consult customer service for proper repair or replacement.
Motor Runs Too Slow (or Slows Down Under Load)	Engine RPM too slow.	Tractor must be operated at the 540 PTO speed as indicated on the tachometer.

OPERATION

OPERATION

Problem	Possible Cause	Remedy
Motor Stops (Stops under Load)	Pump drive damaged.	Check drive shaft attachment to the tractor.
	Logic valve o-ring failure (gear systems).	Remove logic valves and inspect seals. Replace as required.
	Damaged o-ring on solenoid valve.	Remove solenoid valve. Replace seals as required.
	Pump worn or defective.	Test to confirm, Repair or replace as required.
	Motor damaged or defective.	Confirm pump is working correctly, Check that spindle is not locking up. Replace or repair the motor as required.
	Incorrect oil in system.	Flush and fill with proper oil per the specifications.
	Air in the oil.	Locate the source of the air intake and fix. Flush and fill the oil as required.
	Excessive ground speed for mowing conditions.	Operator abuse.
	Excessive internal leakage in pump/motor.	Confirm with pressure/flow test and replace or repair as required.
	Low relief valve setting.	Check the setting using a pressure/flow meter with a restrictor valve. Adjust or replace as needed.
Restrictions in the system.	Identified by a concentration of heat due to crimped hydraulic line, relief valve failure or contamination.	
Pump Seizure (Pump Locks Up)	Lack of oil.	Repair or replace the pump or motor. Fill the oil to the correct level and check for leaks.
Pump Wear (Rapid Excessive Wear)	Inadequate or lack of pump prime during initial start up.	Pumps must be properly primed prior to initial startup. Consult the technical service manual or contact customer service for proper procedures.
	Improper assembly.	Pump may have been reassembled incorrectly by the dealer following a prior failure. Rebuild or replace.
	Contamination.	Contaminants in the system will damage the components. Repair or replace the affected components, then flush and refill with clean oil. Inspect the tank for debris.
	Defective pump.	Confirm defect with customer service and replace.

OPERATION

Problem	Possible Cause	Remedy
Spindle Leaking At Motor	Due to motor seal failure (hydraulic oil leak).	See section on motor seal failure and repair as needed.
	Motor Loose or bolts missing.	Bolts should be checked every 8 hrs. Loss of torque will result in seal failure and leakage.
	Gasket torn due to movement of motor on spindle flange.	See above.
	Excessive back pressure in spindle.	Remove the spindle vent plug and check for clogs or contamination.
Spindle Leaking Around Bottom Seal	Seal damaged due to debris.	Replace as required. Check for damaged or missing seal guard.
	Bearings loose.	Disassemble the spindle and inspect the bearings for damage. Re-assemble and properly pre-load the bearings based on the technical service manual.
	Seal blown out due to excessive back pressure.	Remove the spindle vent plug and check for clogs or contamination.
Spindle Leaking at Relief Vent	Relief fitting installed in the fill hole (Wrong Hole)	Install the vent in the top most hole or even with the top of the top bearing race. The lower hole is the fill hole and should have a grease zerk or plug installed.
	Spindle Overfilled	Overfilling will result in the lubricating oil being expelled from the vent.
Spindle Overheating	Low grease level in the spindle.	Fill lubricant until it can be seen in the top most (vent plug) hole.
	Excessive bearing preload.	Disassemble the spindle and inspect the bearings for wear. Re-assemble following the bearing pre-load specifications in the Technical Service Manual.
	Blade bar bolts are too long.	Installing the incorrect bolts (too long) for the blade carrier will allow the bolts to contact the lower bearing and will lock up the spindle. Install the correct bolts.

OPERATION

OPERATION

Problem	Possible Cause	Remedy
Spindle Shaft Loose or Falls Out	Bearing pre-load adjusting nut and/or lock nut failure.	Locking washers are provided to retain the preload lock nut in place. Improper installation of the washer and locking mechanism will allow the lock nuts to back off. Re-assemble following the recommended procedures.
	Bearing cups or cones not installed properly.	Disassemble and check for wear. Follow reassembly procedures indicated in the technical service manual.
	Severe upper bearing failure.	Usually due to lack of lube. Replace the bearing(s) and make sure the spindle is properly filled. Also check for leakage and repair as needed.
Spindle Locks Up (Seizes and Won't Turn)	Loss of lubrication in spindle.	Indicated by catastrophic failure of the upper bearing. See the previous section.
	Excessive bearing preload.	Disassemble the spindle and inspect the bearings for wear. Re-assemble following the bearing pre-load specifications in the technical service manual.
	Blade bar bolts too long.	Installing the incorrect bolts (too long) for the blade carrier will allow the bolts to contact the lower bearing and will lock up the spindle. Install the correct bolts.
	Interference due to bent seal protector.	Inspect the seal guard ring (welded to the blade carrier or bar). Replace or repair as needed.
Starter on Tractor Won't Crank	Wire harness incorrectly installed.	Check harness attachment to the ignition switch and to the battery. Also, check for proper ground.
Tractor Battery Dead or Low (Continuous Power Draining)	On/Off switch malfunction.	Inspect to ensure power to switch is interrupted when the switch is in the off position.
	Short to ground in wire harness.	Inspect for damage or heat stress to the harness. Check for shorted wires or melted insulation. Check proper connection to the ignition switch and battery.
	Battery failure.	Test the battery and replace per the tractor manufacturer's recommendation.
	Tractor issues.	Follow tractor manufacturer recommendations for troubleshooting electrical problems with the tractor.





MAINTENANCE SECTION

Maintenance Section 5-1

MAINTENANCE

MAINTENANCE

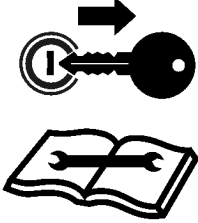
HAZARDS WITH MAINTENANCE OF IMPLEMENT

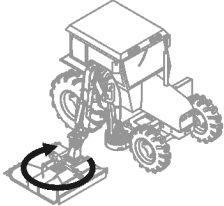
				
<p>Periodically inspect all moving parts, lubricate drivelines, and tighten all fasteners</p>	<p>Lower mower head to ground or block up before servicing</p>	<p>Stop engine remove key before conducting maintenance</p>	<p>Set mower head securely on the ground before servicing blades</p>	<p>Thrown Objects Hazard Ensure blades rotate clockwise viewed from above mower head</p>



AVOID DEATH OR SERIOUS INJURY FROM COMPONENT FAILURE BY KEEPING IMPLEMENT IN GOOD OPERATING CONDITION BY PERFORMING PROPER SERVICE, REPAIRS AND MAINTENANCE.





BEFORE PERFORMING SERVICE, REPAIRS AND MAINTENANCE ON THE IMPLEMENT:

- STOP ENGINE AND PTO, engage parking brake, lower implement, allow all moving parts to stop and remove key before dismounting from tractor.
- PLACE implement on ground or securely block up raised equipment. Use large blocks on soft or wet soil.
- PUSH and PULL Remote Hydraulic Cylinder lever to relieve hydraulic pressure.
- DISCONNECT Pump solenoid valve or PTO driveline connection before servicing mower head.
- WEAR SAFETY GLASSES (with side shields marked to comply with ANSI Z87), PROTECTIVE GLOVES and follow SAFETY PROCEDURES when performing service, repairs and maintenance on the implement:
- Always WEAR protective GLOVES when handling blades, knives, cutting edges or worn component with sharp edges.
- Always WEAR GLOVES and SAFETY GLASSES when servicing hot components.
- AVOID CONTACT with hot hydraulic oil tanks, pumps, motors, valves and hose connection surfaces.
- SECURELY support or BLOCK UP raised implement, framework and lifted components before working underneath equipment.
- FOLLOW INSTRUCTIONS in maintenance section when replacing hydraulic cylinders to prevent component falling.
- STOP any implement movements and SHUT-OFF engine before doing any work procedures.
- USE ladder or raised stands to reach high equipment areas inaccessible from ground.
- ENSURE good footing by standing on solid flat surfaces when getting on implement to perform work.
- FOLLOW manufacturer's instructions in handling oils, solvents, cleansers, and other chemical agents.
- DO NOT change any factory-set hydraulic calibrations to avoid component or equipment failures.
- DO NOT modify or alter implement, functions or components.
- DO NOT WELD or repair rotating mower components. These may cause vibrations and component failures being thrown from mower. *PN HMBM-01*

MAINTENANCE

MAINTENANCE

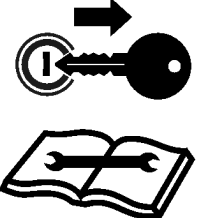
HAZARDS WITH MAINTENANCE OF IMPLEMENT(continued)

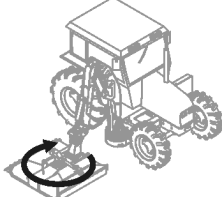
				
<p>Periodically inspect all moving parts, lubricate drivelines, and tighten all fasteners</p>	<p>Lower mower head to ground or block up before servicing</p>	<p>Stop engine remove key before conducting maintenance</p>	<p>Set mower head securely on the ground before servicing blades</p>	<p>Thrown Objects Hazard Ensure blades rotate clockwise viewed from above mower head</p>

PERFORM SERVICE, REPAIRS, LUBRICATION AND MAINTENANCE OUTLINED IN IMPLEMENT MAINTENANCE SECTION:

- INSPECT for loose fasteners, worn or broken parts, leaky or loose fittings, missing or broken cotter keys and washers on pins, and all moving parts for wear.
- REPLACE any worn or broken parts with authorized service parts.
- Inspect mower blade spindle to ensure bearing pre-load. If loose repair before operating.
- LUBRICATE unit as specified by lubrication schedule.
- NEVER lubricate, adjust or remove material while it is running or in motion.
- TORQUE all bolts and nuts as specified.

BLADE INSPECTION:

- Inspect blade carrier and blades daily.
- Check blade and blade carrier BOLT TORQUE daily. Loose bolts can cause blade or blade bolt failures.
- REPLACE, bent, damage, cracked and broken blades immediately with new blades.
- AVOID blade failures and thrown broken blades. DO NOT straighten, weld, or weld hard-facing blades.

SAFETY SHIELDS, GUARDS AND SAFETY DEVICES INSPECTION:

- KEEP all Deflectors, Chain Guards, Steel Guards, Gearbox Shields, and PTO integral shields, Bands, Side Skirts and Skid Shoes in place and in good condition.
- REPLACE any missing, broken or worn safety shields, guards and safety devices.

⚠ WARNING Cancer and Reproductive Harm www.P65Warnings.ca.gov. PN HMBM-01 (2) str

MAINTENANCE

PARTS INFORMATION

Bush Hog mowers use balanced and matched system components for blade carriers, blades, cuttershafts, knives, knife hangers, rollers, drivetrain components, and bearings. These parts are made and tested to Bush Hog specifications. Non-genuine "will fit" parts do not consistently meet these specifications. The use of "will fit" parts may reduce mower performance, void warranties, and present a safety hazard. Use genuine Bush Hog mower parts for economy and safety. (SPBH-1) str

SEE YOUR BUSH HOG DEALER

LUBRICATION INFORMATION

General

Refer to the lubrication diagram and grease daily all the points shown.

1. Power take-off shaft - The PTO shaft should be regularly examined to ensure that it is in good condition together with the guards. The universal joints should be greased very sparingly, i.e., one shot a week.

NOTE: *Overgreasing a universal joint will blow out the cork or neoprene sealing rings that exclude the dirt from the needle bearing inside.*

2. The two halves of the plastic guard should be checked daily to ensure that they can spin freely on the shaft. The nylon slip rings which support the guard on the drive shaft should be lightly greased at weekly intervals.
3. The telescoping drive shaft should be similarly separated and grease applied to the internal shaft at approximately 100 hour intervals.
4. Your Boom uses greased bushings that need lubrication, and with proper lubrication should last the lifetime of the machine.

MAINTENANCE

MAINTENANCE

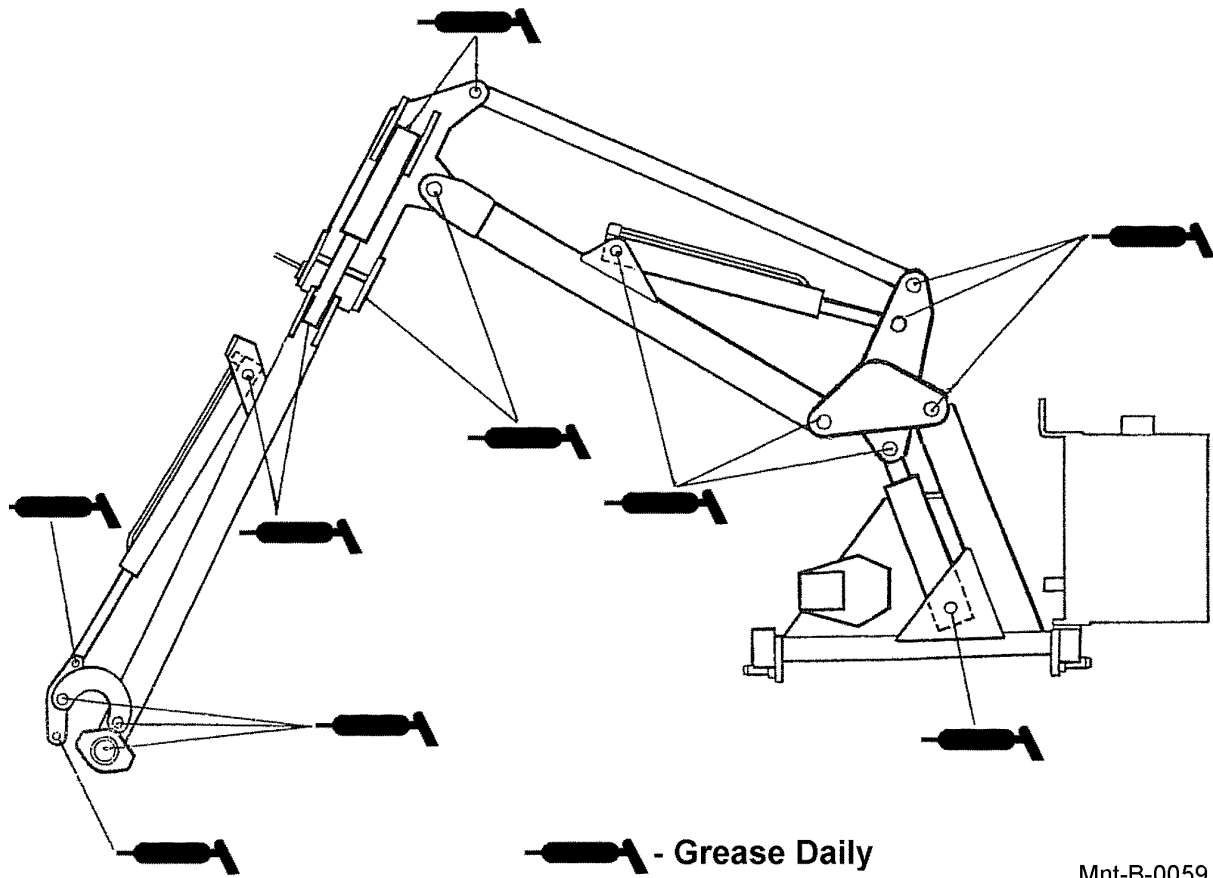

Mnt-B-0059

PTO SHAFT

Regularly check the PTO guards for damage and ensure the anti-rotation chains are in place and that their anchor points are in good condition.



DANGER

Make sure the PTO shield, integral driveline shields, and input shields are installed when using PTO-driven equipment. Always replace any shield if it is damaged or missing. (S3PT-8) str



DANGER

KEEP AWAY FROM ROTATING ELEMENTS to prevent entanglement and possible death or serious injury. (SG-24)str



MAINTENANCE

MAINTENANCE

PTO Lubrication

Lubricate the shaft at the points shown below at the intervals indicated using N.L.G.I. #2 Grease.

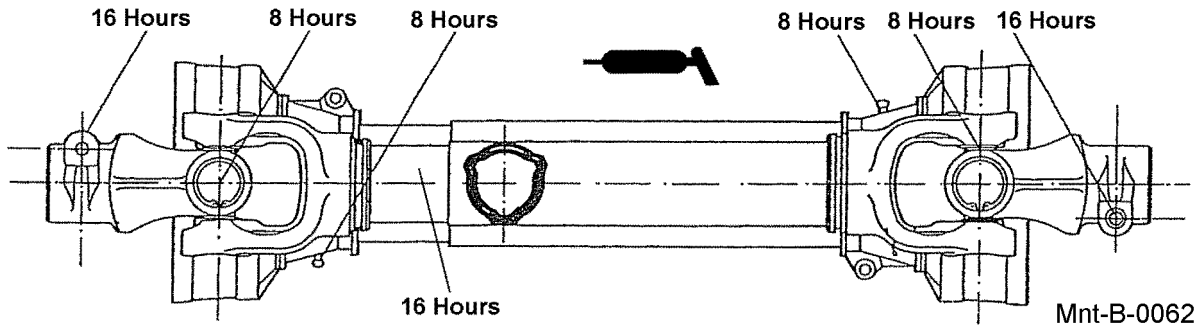

CUTTING PTO SHAFT



Always disconnect the main PTO Driveline from the Tractor before performing service on the Implement. Never work on the Implement with the tractor PTO driveline connected and running. Rotating Parts, Blades or Drivelines could turn without warning and cause immediate entanglement, injury or death. (S3PT-11)str

1. Separate the two PTO half shafts from one another.
2. Loosen the three screws on driveline shield.

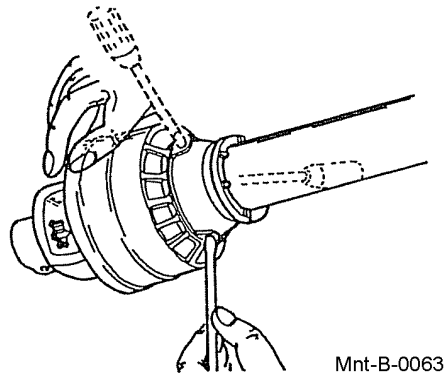

3. Remove the three screws for each shaft half.

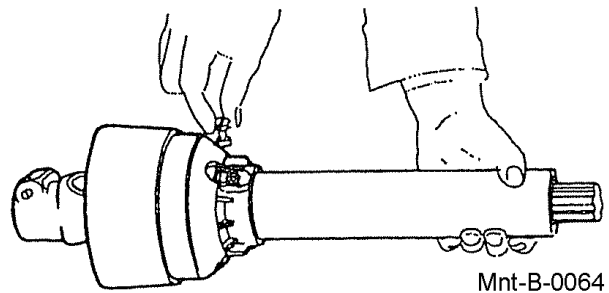

MAINTENANCE

4. Separate the shafts from the shields.

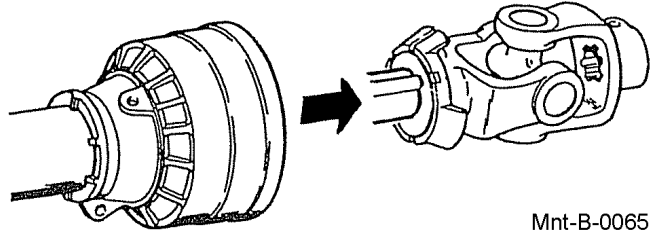

5. Cut the calculated length off both male and female shaft halves to give the required PTO length.

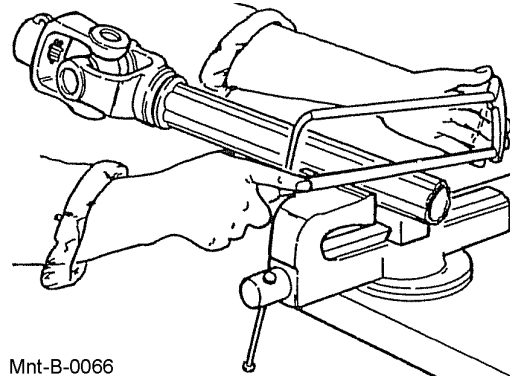

6. De-burr the ends of the cut shafts.

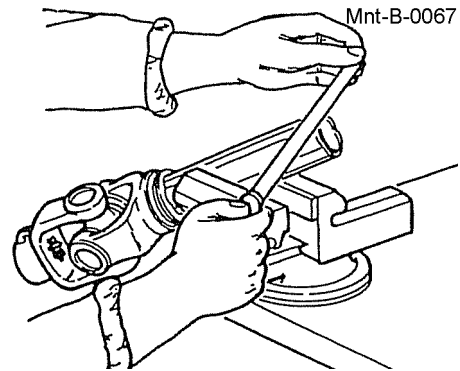

7. Cut the same length off both shield halves as cut from the shafts.

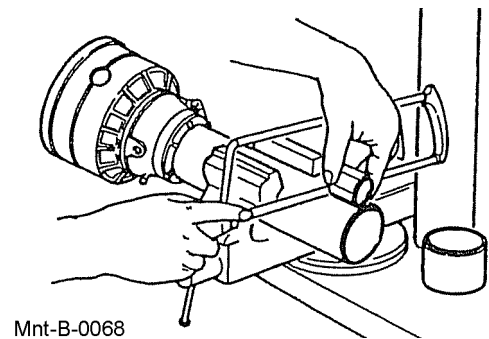

8. Slide the shafts into the shields. Replace the three screws and secure. Reassemble both shaft halves together.

MAINTENANCE

MAINTENANCE

P.T.O. GEARBOX

The gearbox oil should be changed every working year or at 600 hour intervals, whichever occurs first. On level ground gearbox should be filled until oil is visibly level with the lip of the filler plug aperture. Do not attempt to fill by removing the breather as the depth of tapped thread in the casing at this point is insufficient to allow repeated loosening and tightening of the breather plug.

The gearbox capacity is 1-1/2 pints of Multi-Purpose Gear Oil P/N 00786250

HYDRAULIC SYSTEM

Oil Supply

Check daily the oil level in the reservoir. No fixed time period can be quoted for oil changes as operating conditions and maintenance standards vary so widely. Burnt and scorched oil odors and the oil darkening and thickening are all signs of oxidation and indicate the oil should be changed.

Moisture which results from condensation can become entrapped in the oil and cannot be removed by filtration so that contamination is a progressive factor.

Contamination can be reduced by:

1. Cleaning off around the reservoir cap before removal, and keeping that area clean.
2. Using clean containers when replenishing the system.
3. Regular servicing of the filtration system.

Filtration Maintenance

A 125-micron suction strainer and a low-pressure 10-micron full flow return line filter protect the machine.

Suction strainer

The strainer is permanently fixed within the reservoir.

Should symptoms of pump cavitation or spongy intermittent operation occur the tank must be drained and flushed out with a suitable cleaning agent e.g. clean diesel oil.

Return Line Filter

The elements should be changed after the first 50 hours and thereafter at 500-hour intervals. It is important to note hours worked because if the filter becomes blocked an internal by-pass within the canister will operate and no symptoms of filter malfunction will occur to jog your memory.

MAINTENANCE

HYDRAULIC HOSES

The condition of all hoses should be carefully checked during routine service of the machine. Hoses that have been chafed or damaged on their outer casing should be securely wrapped with waterproof adhesive tape to stop the metal braid from rusting. Hoses that have been suffered damage to the metal braid should be changed at the earliest opportunity.

Hose Replacement

1. Replace one hose at a time to avoid the risk of wrong connections.
2. When the hose is screwed to an additional fitting or union, use a second wrench on the union to avoid breaking both seals.
3. Do not use joint compound on the threads.
4. Avoid twisting the hose. Adjust the hose line to ensure freedom from rubbing or trapping before tightening hose end connections.

Before changing hoses, study the installation. These are carefully calculated to prevent hose damage during operation. Always replace hoses in exactly the same manner. This is especially important for the flail hoses where they must be crossed, upper to lower, at the dipper and head pivots. The 90 degree elbows at the head bracket must point directly across the pivot and the hoses must have no slack at this point.

Two hoses clips are provided at either end of the large bore suction and return hoses. These should be positioned so that their worm drive barrels are opposed at 180 degrees to reduce the possibility of air entering the system. A stop tap is provided to enable the suction hose to be changed without draining the tank.

Hose Warranty

Warranty is limited to replacement of hoses which have failed due to faulty materials of manufacture. Warranty will not be considered on hoses that have suffered damage by abrasion, cuts or being pinched or trapped while in work. Neither will a claim be considered where a hose end has been damaged by a blow or where the threads or unions have been damaged by over-tightening.

RECOMMENDED HOSE END TORQUE VALUES FOR 37 DEGREE ANGLE STEEL HOSE END FITTINGS			
DASH SIZE	NOMINAL SIZE (IN)	TORQUE (IN. LBS)	VALUE* (FT. LBS)
-4	1/4	140	12
-6	3/8	230	19
-8	1/2	450	38
-10	5/8	650	54
-12	3/4	900	75
-16	1	1200	100
-20	1-1/4	1600	133
-24	1-1/2	2000	167
-32	2	2800	233

*Straight threads do not always seal better when higher torques are used. Too much torque causes distortion and may lead to leakage.

MAINTENANCE

CABLES

The cables operate on a push/pull system with the spool centering springs always returning the spool to the neutral position when the handle is released.

Care should be taken during installation and operation to ensure that the cables are not trapped or kinked. Any abrasion or damage to the outer casing should be sealed with plastic insulation tape to avoid moisture penetrating.

No routine adjustment of the cables are necessary as they do not stretch. The threaded collar is correctly adjusted when the lever is in a vertical position in its housing allowing an equal amount of travel in either direction.



Do not lubricate the cables which are assembled with a special lubricant during manufacture.

NOTE: Be careful in determining the correct cable connections on both the control unit and the valve in the event of cable replacement.

HOSE CONNECTIONS

Main Control Valve

1. Supply
2. Return
3. Lift Base
4. Lift Gland
5. Reach Base
6. Reach Gland
7. Angle Base
8. Angle Gland
9. Breakaway Cylinder

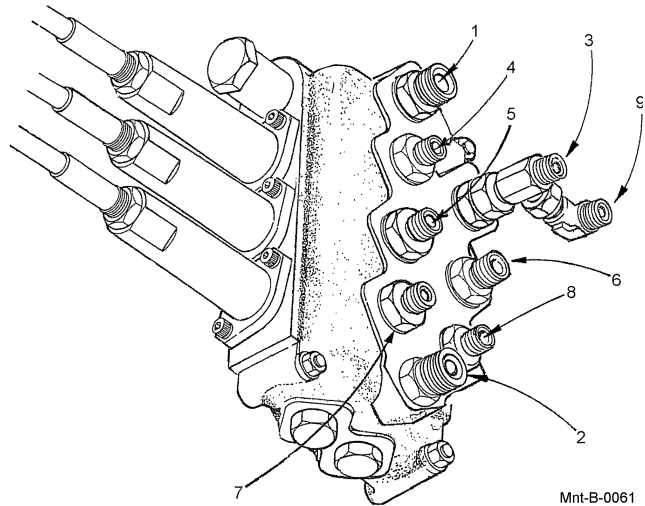

Mnt-B-0061

CYLINDER ROD MAINTENANCE

It is important to visually inspect the hydraulic cylinder rods daily before use. It is highly recommended that while the machine is stored or getting very little use that a protectant is applied to the hydraulic cylinder rods to prevent degradation. If the machine receives more frequent use, be sure to fully cycle each cylinder function so that the cylinder rod is coated by the systems hydraulic fluid. Depending on your operating environment it may be necessary, under normal operating conditions, to apply a protective lubricant to the cylinder rods for protection against rust and pitting. Hydraulic fluid may provide a suitable amount of protection, but remember any protectant can attract dust and debris so attention must be given to the cylinder rods daily. Also remember that any other protectant must be compatible with hydraulic fluid. Bush Hog is not responsible for rust or pitting of the cylinder rod due to weather exposure or impacts from normal operation or mounting. If hydraulic cylinders and or the cylinder rods are damaged as a result of the rods rusting or pitting, the hydraulic cylinders and rods will not be covered under warranty by Bush Hog.

MAINTENANCE

BOOM CYLINDER REMOVAL AND REPLACEMENT INSTRUCTIONS

1. Clear the area of all personnel before lowering the boom mower head.
2. From the tractor seat with your seat belt fastened around you, Lower the boom mower head to the ground. Extend the boom to the furthest reach and lower the mower head flat on the ground. DO NOT attempt to replace the cylinders with the boom in the raised or transport position.
3. Shut off the tractor, engage the parking brake, place the tractor transmission in the park position, and remove the key before dismounting.
4. Allow the system to cool to room temperature before removing any hydraulic components.
5. Wear Safety glasses and impenetrable gloves when working with hydraulic hoses and fittings.
6. Release all oil pressure from the hydraulic circuit by manually stroking each valve section with the tractor engine off. Utilize the Manual Override function if the unit is equipped with an electric over hydraulic valve.
7. Utilize blocks, jack stands or a suitable over head hoist to support the weight of the boom section and remove pressure from the cylinder mounting pins.
8. Check to see that the cylinder to be replaced is not under pressure by moving the cylinder pins by hand. The pins should be loose and should slide from the pin bore easily. If the pins are tight and cannot be moved, the cylinder may be under pressure. Make sure the boom components are properly supported and that the pressure is relieved from the circuit.
9. Cylinder assemblies are heavy and can fall when the pins are removed. Support the hydraulic cylinder with a suitable hoist or jack.
10. Slowly loosen the hydraulic connections to the cylinder. Carefully unscrew hose fitting and allow any remaining pressure to bleed off. Use Extreme Care. Oil must be cool, and the technician should stand to the side to prevent exposure to any hydraulic oil. Always consult the Material Safety Data Sheet and wear any required Personal Protective Equipment. A catch pan may be required to retain any spilled oil.
11. Cap both ends of the fitting with suitably sized metal caps.
12. Remove the cylinder pins starting with the ROD end cylinder pin. Make sure the cylinder is properly supported, and remove the base end cylinder pin. The cylinder may be heavy, use proper lifting techniques to lift and handle the cylinder. If needed, get assistance from another person to safely lift the cylinder from the machine.
13. Measure the distance between the cylinder pin holes and extend the new cylinder the correct length prior to attempting an installation.
14. Install the new cylinder in place and install both cylinder pins and retaining hardware.
15. Remove the metal caps, and re-install the hydraulic hoses.
16. Check the hydraulic reservoir of the boom mower to ensure there is sufficient oil. Follow the manufactures recommendations for proper oil type and filtering techniques and requirements to add oil to the system.
17. Clear the area of all persons prior to starting the tractor.
18. Consult the Operator's Manual for instruction in regard to the proper operating procedure.
19. From the tractor seat, with the seat belt fastened, operate the boom to ensure proper operation of the boom function.
20. From the tractor seat, with the seat belt fastened, operate the boom controls to fully extend and retract the new cylinder several times to purge any trapped air from the system.
21. From the tractor seat, with the seat belt fastened, look for signs of and oil leak. If an oil leak is observed, shut the tractor down and follow the steps to remove pressure from the hydraulic circuit. Identify the source of the leak, and resolve the issue.
22. Upon completion of the required repairs, return to Step # 16 to recheck the cylinder for proper operation.

MAINTENANCE

HYDRAULIC COMPONENT MAINTENANCE SCHEDULE

MAINTENANCE

Component	Hours of Operation											
	Installation	200	400	600	800	1000	1200	1400	1600	1800	2000	2200
Pump Drive Shaft Check and Lubricate	x	x	x	x	x	x	x	x	x	x	x	x
Pump Mounting Bolt torque check (Inspect Daily)	x	x	x	x	x	x	x	x	x	x	x	x
Charge Pump Filter	Installation	x			x				x			
Pressure Filter to the Control Valve	Installation	x			x				x			
Return Canister Filter Element	Installation	x			x				x			
Hydraulic Oil Change	Installation	x							x			
Hydraulic Oil Particle Count Testing	x	x			x				x			
Hydraulic Tank Breather Filter	Installation	Inspect							Replace			
Hydraulic Tank Suction Screen	Installation	Inspect							Inspect			
Hydraulic Hose Inspection/Replacement	Installation	Inspect	Inspect	Inspect	Inspect	Inspect	Inspect	Inspect	Inspect	Inspect	Inspect	Inspect
Cooling Fan Clean and Inspect	Daily	Daily	Daily	Daily	Daily	Daily	Daily	Daily	Daily	Daily	Daily	Daily
Check Hydraulic Fluid Level (Inspect Daily)	Daily	Daily	Daily	Daily	Daily	Daily	Daily	Daily	Daily	Daily	Daily	Daily
Mower Blades Replace (INSPECT DAILY)		x	x	x	x	x	x	x	x	x	x	x
Blade Bolts Replace (INSPECT DAILY)		x	x	x	x	x	x	x	x	x	x	x
Blade Bar Assembly Replace	Installation					x					x	
Spindle Lube Replacement (INSPECT DAILY)	x					x					x	
Spindle Bearing Pre-load Inspection	x	x	x	x	x	x	x	x	x	x	x	x
Mower Debris Guard Inspect/Replace	x	x	x	x	x	x	x	x	x	x	x	x
Pivot Point Lubrication	Daily	Daily	Daily	Daily	Daily	Daily	Daily	Daily	Daily	Daily	Daily	Daily
King Pin Bearing Replacement	Installation								x			
Pivot Pin Bearing replacement (Steel)	Installation								x			
Pivot Pin Bearing Replacement (Fiber)	Installation					x					x	
Inspect Operation And Safety Decals Replace when faded, torn or missing.	x	x	x	x	x	x	x	x	x	x	x	x

Repeat the Maintenance Schedule based on the hours indicated for the life of the machine

PROPER TORQUE FOR FASTENERS

The chart lists the correct tightening torque for fasteners. When bolts are to be tightened or replaced, refer to this chart to determine the grade of bolts and the proper torque except when specific torque values are assigned in manual text.

RECOMMENDED TORQUE IN FOOT POUNDS UNLESS OTHERWISE STATED IN THE MANUAL*

NOTE: These values apply to fasteners as received from supplier, dry or when lubricated with normal engine oil. They do not apply if special graphited or molydisulphide greases or other extreme pressure lubricants are used. This applies to both UNF fine and UNC coarse threads.

MAINTENANCE

MAINTENANCE

TORQUE SPECIFICATIONS - DRY TORQUE

AMERICAN Bolt Head Markings

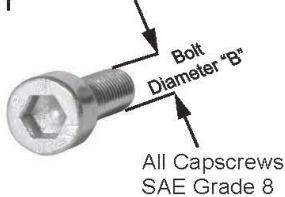
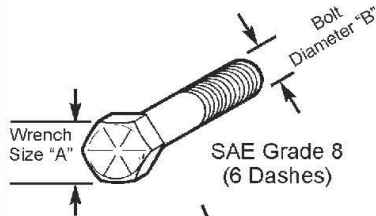

Proper torque for American fasteners.
Recommended Torque in Foot Pounds (Newton Meters).*

WRENCH SIZE (IN.) "A"	BOLT DIAMETER (IN.) "B" AND THREAD SIZE	SAE GRADE 2	SAE GRADE 5	SAE GRADE 8
7/16	1/4 - 20 UNC	6 (7)	8 (11)	12 (16)
7/16	1/4 - 28 UNF	6 (8)	10 (13)	14 (18)
1/2	5/16 - 18 UNC	11 (15)	17 (23)	25 (33)
1/2	5/16 - 24 UNF	13 (17)	19 (26)	27 (37)
9/16	3/8 - 16 UNC	20 (27)	31 (42)	44 (60)
9/16	3/8 - 24 UNF	23 (31)	35 (47)	49 (66)
5/8	7/16 - 14 UNC	32 (43)	49 (66)	70 (95)
5/8	7/16 - 20 UNF	36 (49)	55 (75)	78 (106)
3/4	1/2 - 13 UNC	49 (66)	76 (103)	106 (144)
3/4	1/2 - 20 UNF	55 (75)	85 (115)	120 (163)
7/8	9/16 - 12 UNC	70 (95)	109 (148)	153 (207)
7/8	9/16 - 18 UNF	79 (107)	122 (165)	172 (233)
15/16	5/8 - 11 UNC	97 (131)	150 (203)	212 (287)
15/16	5/8 - 18 UNF	110 (149)	170 (230)	240 (325)
1-1/8	3/4 - 10 UNC	144 (195)	266 (360)	376 (509)
1-1/8	3/4 - 16 UNF	192 (260)	297 (402)	420 (569)
1-5/16	7/8 - 9 UNC	166 (225)	430 (583)	606 (821)
1-5/16	7/8 - 14 UNF	184 (249)	474 (642)	668 (905)
1-1/2	1 - 8 UNC	250 (339)	644 (873)	909 (1232)
1-1/2	1 - 12 UNF	274 (371)	705 (955)	995 (1348)
1-1/2	1 - 14 UNF	280 (379)	721 (977)	1019 (1381)
1-11/16	1-1/8 - 7 UNC	354 (480)	795 (1077)	1288(1745)
1-11/16	1-1/8 - 12 UNF	397 (538)	890 (1206)	1444 (1957)
1-7/8	1-1/4 - 7 UNC	500 (678)	1120 (1518)	1817 (2462)
1-7/8	1-1/4 - 12 UNF	553 (749)	1241 (1682)	2013 (2728)
2-1/16	1-3/8 - 6 UNC	655 (887)	1470 (1992)	2382 (3228)
2-1/16	1-3/8 - 12 UNF	746 (1011)	1672 (2266)	2712 (3675)
2-1/4	1-1/2 - 6 UNC	870 (1179)	1950 (2642)	3161 (4283)
2-1/4	1-1/2 - 12 UNF	979 (1327)	2194 (2973)	3557 (4820)

METRIC

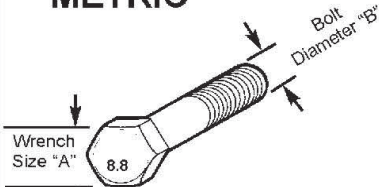

Numbers appearing on bolt heads indicate ASTM class.

*Use 75% of the specified torque value for plated fasteners. Use 85% of the specified torque values for lubricated fasteners.

Proper torque for Metric fasteners.
Recommended torque in Foot Pounds (Newton Meters).*

WRENCH SIZE (mm) "A"	BOLT DIA. (mm) "B"	ASTM 4.6	ASTM 8.8	ASTM 9.8	ASTM 10.9
8	5	1.8 (2.4)		5.1 (6.9)	6.5 (8.8)
10	6	3 (4)		8.7 (12)	11.1 (15)
13	8	7.3 (10)		21.1 (29)	27 (37)
16	10	14.5 (20)		42 (57)	53 (72)
18	12	25 (34)	74 (100)	73 (99)	93 (126)
21	14	40 (54)	118 (160)	116 (157)	148 (201)
24	16	62 (84)	167 (226)	181 (245)	230 (312)
30	20	122 (165)	325 (440)		449 (608)
33	22		443 (600)		611 (828)
36	24	211 (286)	563 (763)		778 (1054)
41	27		821 (1112)		1138 (1542)
46	30	418 (566)	1119 (1516)		1547 (2096)

Mnt-B-0005

MAINTENANCE

FLAILHEAD

1. Frequently inspect the rotor assembly for damaged or missing flails. Bolts and nuts securing the flails to the rotor should be regularly checked and kept tight. The correct torque setting for these locknuts is 135 Nm (100 lbs/ft.). Use only the correct flail bolt and locking nut. Check the flail pivot bushes for possible damage or wear. They do not require oil.
2. Do not attempt to run the rotor with flails missing. Imbalance will cause severe vibration and can rapidly damage the rotor shaft bearings. As an emergency measure, if a flail is broken off or lost, remove another on the opposite site of the rotor to retain balance. Always replace flails in opposite pairs and never match up a new flail with a resharpened one which will of course be lighter.
3. Blunt flails absorb a lot of power and leave an untidy finish to work. They should be sharpened on a grindstone or with a portable grinder periodically.
4. Wear protective gear when sharpening flails.
5. Ensure that the bearing housings and hydraulic mounting nuts and bolts are kept tight. They should be checked during servicing.

MAINTENANCE

Flail Head Inspection



DANGER Inspect the Blades daily for abnormal wear. REPLACE ALL BLADES on the carrier IMMEDIATELY if any blades have:

- Become bent or deformed from its original shape, or
- Wear inside the blade bolt hole, or
- Any cracks are visible, or
- Deep gouges in the blade's surface are present, or
- Gouges or chipped areas in the cutting edge are larger than 1/4"(8mm), or
- The material on the leading edge has been worn away by more than 1/4"(8mm)

DO NOT straighten, sharpen, weld or hard-face blades.

Failure to replace worn or damaged blades may lead to catastrophic failure of the blades and ejection of the broken part with tremendous force which may cause serious bodily injury or death.

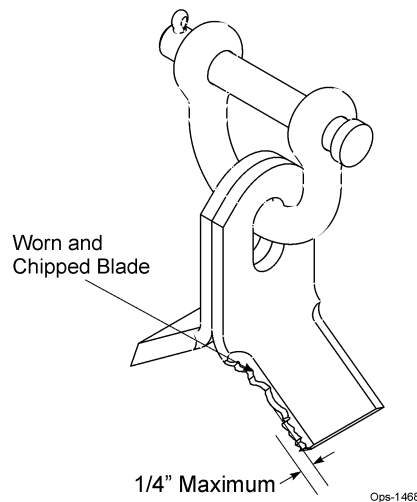

Always replace blades in sets.

- Blades that are damaged may indicate severe service or abuse. If one blade is worn or damaged other blades on the same shaft will have been subjected to the same severe service or abuse.
- The Flail rotor turns at speeds exceeding 2000 RPM and is dynamically balanced at the factory. Differences in blade weight between used blades with loss of material from gouges or wear as compared to new blades can cause severe vibration and damage to the Flail rotor. Always replace blades as complete sets.

Important

Use only genuine Bush Hog replacement blades and fasteners. Other blades and fasteners may not meet the Bush Hog requirements and could fail during operation resulting in part being thrown out from under the mower.



CAUTION Never attempt to sharpen blades. OPS-U-0046 str

MAINTENANCE

MAINTENANCE

Blade Pins and D-Ring Inspection

Inspect Blade Pins and D-Rings daily for wear or damage as follows:



Inspect the Blade pins and D-Rings daily for abnormal wear. Make sure the cotter pins are in place and properly spread. REPLACE BLADE Pins and D-Rings IMMEDIATELY if they have:

- Visible cracks or
- If a Pin or D-Ring has visible worn areas, or
- If a Pin or D-Ring has gouges or chipped areas

Failure to replace abnormally worn pins or D-Rings may lead to catastrophic failure and ejection of the broken part which may cause serious bodily injury or death.

Always replace the pins and D-Rings whenever excessive wear is noticed.

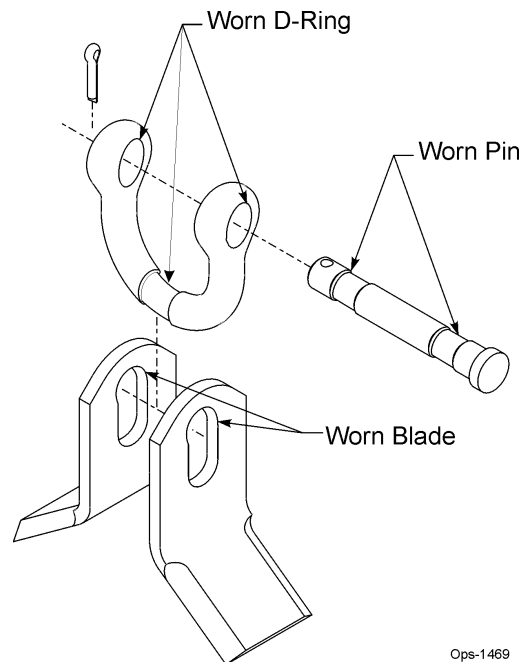

Ops-1469

Important

If the cotter pins are broken by contact with other flail blades, remove the pin and reverse the direction the pin is inserted through the D-Ring so that the cotter pin is on the opposite side of the D-Ring. This will prevent the next set of blades from swinging back and hitting the cotter pin. *OPS-U-0045 str*

MAINTENANCE

Flail Axe Blade Inspection



DANGER Inspect the Blades daily for abnormal wear. REPLACE ALL BLADES on the carrier IMMEDIATELY if any blades have:

- Become bent or deformed from its original shape, or
- Oval shape wear inside the blade bolt hole, or
- Any cracks are visible, or
- Deep gouges in the blade's surface are present, or
- Gouges or chipped areas in the cutting edge are larger than 1/4"(8mm), or
- The material on the leading edge has been worn away by more than 1/4"(8mm)

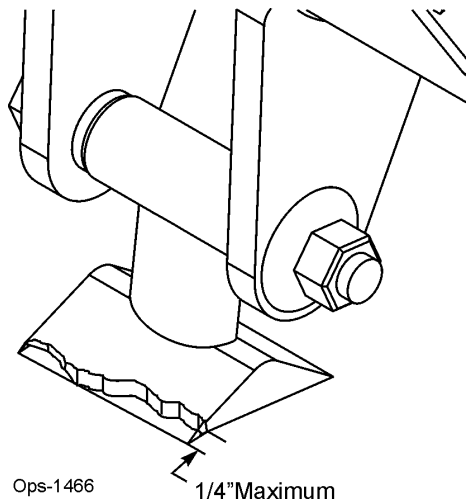

Failure to replace worn or damaged blades may lead to catastrophic failure of the blades and ejection of the broken part with tremendous force which may cause serious bodily injury or death.

Always replace blades in sets

- Blades that are damaged may indicate severe service or abuse. If one blade is worn or damaged other blades on the same shaft will have been subjected to the same severe service or abuse.
- The Flail Axe rotor turns at speeds exceeding 2000 RPM and is dynamically balanced at the factory. Differences in blade weight between used blades with loss of material from gouges or wear as compared to new blades can cause severe vibration and damage to the Flail Axe rotor. Always replace blades as complete sets.

Important

Use only genuine Bush Hog replacement blades, blade bolts and fasteners. Other blades and bolts may not meet the requirements of Bush Hog and fail during operation resulting in part failing and being thrown out from under the mower.



Never attempt to sharpen blades. OPS-U-0049 str

MAINTENANCE

Flail Axe Blade Bolt Inspection

Inspect Blade Bolts daily for wear or damage as follows:



CAUTION Inspect the Blade Bolt daily for abnormal wear. REPLACE ALL BLADE BOLTS on the carrier IMMEDIATELY if any bolts have:

•Visible cracks, or

- If the blade bolt is worn or any recessed area is visible on the bolt, or
- If Blade Bolt has gouges or chipped areas, or
- If Bushing fits loose in the Rotor Shaft.

DO NOT straighten, sharpen, weld or hard-face blades

Failure to replace worn or damaged blades may lead to catastrophic failure of the blades and ejection of the broken part with tremendous force which may cause serious bodily injury or death.

Always replace Blade Bolts with new bolts and new bushings whenever replacing the Blades. To tighten bolts and nuts, first apply thread lock to nut. Make sure to tighten bolts and nuts just enough to allow the blades to swing freely, and not bend the cuttershaft lugs. If cuttershaft lugs are bent together because of over tightening the blades will not swing freely. OPS-U-0043 str

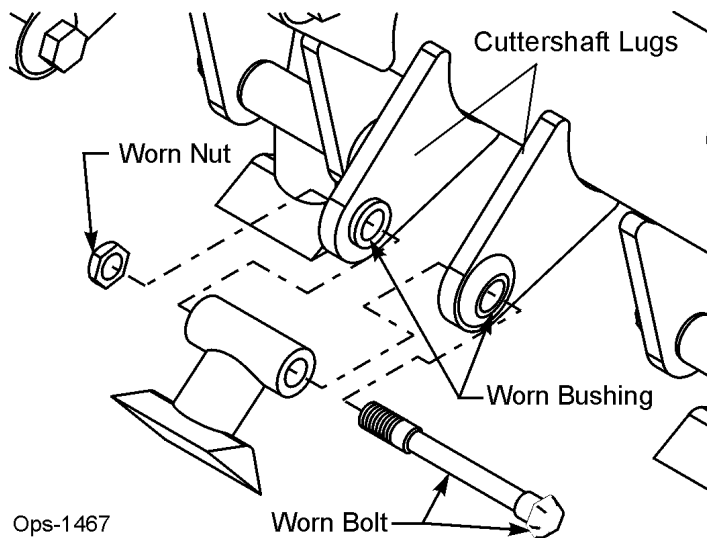

SEGURIDAD

  <p>Manual do Operador www.algqr.com/bpp</p>	  <p>Benutzerhandbuch www.algqr.com/bbg</p>
<p>Caso você não leia inglês: antes de operar o equipamento, peça para alguém traduzir as mensagens de segurança ou visite a web e obtenha tais mensagens ou os decalques traduzidos.</p>	<p>Falls Sie nicht Englisch sprechen: Bevor Sie die Geräte in Betrieb nehmen, bitten Sie eine Englisch sprechende Person darum, Ihnen die Sicherheitsmeldung zu übersetzen, oder besuchen Sie die Website; dort finden Sie übersetzte Aufkleber und Sicherheitsmeldungen.</p>
<p>PERIGO</p>	<p>GEFAHR</p>



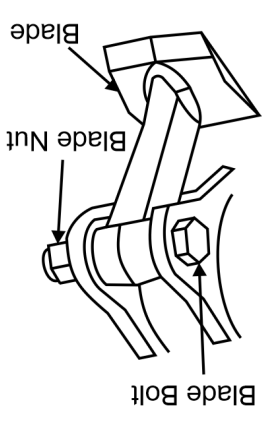

  <p>El Manual del Operador Seguridad vídeo www.algqr.com/avs</p>	  <p>Manuel de l'Opérateur www.algqr.com/bbt</p>
<p>Si no puede leer inglés: antes de poner en funcionamiento este equipo, solicite que alguien le traduzca los mensajes de seguridad o vaya al sitio web para consultar los mensajes de seguridad y las etiquetas ya traducidos.</p>	<p>Si vous ne pouvez pas lire l'anglais : avant d'utiliser l'équipement, demandez à une personne de vous traduire les messages de sécurité ou allez sur le site Internet pour voir la traduction des autocollants et des messages de sécurité.</p>
<p>PELIGRO</p>	<p>DANGER</p>

SEGURIDAD

⚠️ ADVERTENCIA	
<p>PARA EVITAR MUERTE O LESION GRAVE POR EL FALLO DEL ACOPLAMIENTO DE LAS CUCHILLAS:</p> <ul style="list-style-type: none"> • Verifique los tornillos de las cuchillas • DIARIAMENTE para si estan apretados. Apriete los tornillos a torsion de 150 libras pie. SIEMPRE reemplace las cuchillas con tornillos y tuercas nuevas. D720 SP 	 <p>TO AVOID DEATH OR SERIOUS INJURY FROM BLADE ATTACHMENT FAILURE:</p> <ul style="list-style-type: none"> • Check blade bolts DAILY for tightness. • Torque blade bolt to 150 ft lbs. • ALWAYS replace blades with new bolts and nuts.

⚠️ DANGER



RIESGO DE AMPUTACIÓN
<p>PARA EVITAR LESION SERIA POR EL CONTACTO A LA CUCHILLA:</p> <ul style="list-style-type: none"> • Mantengase alejado hasta que todo movimiento a parado. • Mantenga los dedos alejados de la barra de corte al devantar la barra de corte a la posición de transporte. • MANTENGA todas las personas ALEJADAS de las cuchillas del la barra de hoz.
⚠️ PELIGRO



<p>ADVERTENCIA</p> <p>Cáncer y Daño Reproductivo</p> <p>www.P65Warnings.ca.gov</p> <p>D559 SP</p>	<p>WARNING</p> <p>Cancer and Reproductive Harm</p> <p>www.P65Warnings.ca.gov</p>
<p>Para prevenir lesiones graves a usted y/o personas presentes, sea entrenado en la Práctica de Segar Seguro. Compañías de Alamo Group así como AEM y FEMA proporcionan material para entrenar que es esencial para su seguridad y la seguridad de otros al operar este equipo. Haga estos procedimientos de seguridad una parte importante de su día de trabajo. Lea y entienda el Manual de Operadores. No permita que personas sin entrenamiento funcionen este equipo. Contacte a su distribuidor, AEM (www.aem.org), FEMA (314-878-2304, www.FarmEquipment.org), o Alamo Group (www.Alamogroup.com) para la información sobre el material de entrenamiento de Prácticas de Operación para Cortadoras.</p>  <p>www.aigqr.com/bvs</p>	<p>To prevent serious injury to yourself and/or bystanders, be trained in Safe Mowing Practices. Alamo Group Companies as well as AEM and FEMA provide training material that is critical for your Safety and the Safety of others when operating this equipment. Make these Safety Procedures an important part of every workday. Read and understand the Operator's Manual. Do not let untrained individuals operate this equipment. Contact your Dealer, AEM (www.aem.org), FEMA (314-878-2304, www.FarmEquipment.org), or Alamo Group (www.Alamogroup.com) for information on training material or courses that provide training in Safer Operating Practices for Mowers.</p>  <p>www.aigqr.com/bve</p>
<p>IMPORTANTE</p> <p>ESTE CONSCIENTE SEA ENTRENADO</p> <p>ESTE ALERTO Antes de Funcionar</p> <p>ESTE VIVO</p> <p>Cortacésped</p>	<p>IMPORTANT</p> <p>BE AWARE Before Operating</p> <p>BE ALERT this Mower</p> <p>BE ALIVE</p>
<p>ADVERTENCIA</p> <p>PARA EVITAR MUERTE O LESION GRAVE:</p> <ul style="list-style-type: none"> • El uso de piezas no originales puede provocar el fallo de la pieza, creando condiciones peligrosas para el operador y personas presentes. • SOLO use piezas de repuesto genuinas de Bush Hog, Bush Hog por el fabricante que han sido validados y probados para usar en equipo. El fabricante del equipo no puede verificar el material o integridad estructural de piezas de repuesto no genuino suministrados. <p>Contacte a su distribuidor local o BUSH HOG sobre partes de reparo at: 2501 Griffin Ave., Selma Al 36701 Servicio al Cliente: 800-363-6096 Correo Electronico: contactus@bushhog.com</p>  <p>www.aigqr.com/bpm</p>	<p>WARNING</p> <p>TO AVOID DEATH OR SERIOUS INJURY:</p> <ul style="list-style-type: none"> • ONLY use genuine BUSH HOG replacement parts, which have been validated and tested to use on Bush Hog equipment by the manufacturer. • The equipment manufacturer cannot verify the material or structural integrity of third-party supplied non-genuine replacement parts. • Using non-genuine parts can result in the part failing, creating hazardous conditions for operator and bystanders. <p>Contact local dealer or Bush Hog about repair parts at: 2501 Griffin Ave., Selma, Al 36701 Customer Service: 800-363-6096 Email: contactus@bushhog.com</p>  <p>www.aigqr.com/bpm</p>

PELIGRO	DANGER
RIESGO DE OBJETOS LANZADOS	THROWN OBJECTS HAZARD
<p> Cortacésped puede lanzar objetos hasta 300 pies. PARA EVITAR LESION SERIA O MUERTE a operadores y personas presentes: ● CIERRE LA PUERTA DE LA UNIDAD y PARE de operar si las personas presentes o el tráfico se acercan entre 300 pies de la unidad. ● MANTENGA la puerta completamente cerrada al cortar zacate o hierbas. ● ABRA SOLO la puerta para cortar ramas grandes. Mantenga la puerta cerrada en todas las otras condiciones de segar. ● Los Deflectores son SUJETOS AL DESGASTE. Reemplaze si están desgastados o dañados. ● SIEMPRE transporte con la puerta cerrada. ● NO OPERE si las cuchillas están girando en la rotación reversa (opuesto a las llantas del tractor durante el avance de viaje). D717 </p>	<p> Mower can throw objects up to 300 feet. TO AVOID DEATH OR SERIOUS INJURY to operator or bystanders: ● CLOSE MOWER DOOR and STOP operating if bystanders or traffic come within 300 feet. ● KEEP door fully closed when cutting grass and weeds. ● OPEN door ONLY to cut large brush. Keep door closed for all other mowing conditions. ● Deflectors are SUBJECT TO WEAR. Replace if worn or damaged. ● ALWAYS transport with door closed. ● DO NOT OPERATE if blades are rotating in reverse rotation (opposite to the tractor tires during forward travel). </p>

PELIGRO	DANGER
RIESGO DE OBJETOS LANZADOS	THROWN OBJECT HAZARD
<p> PARA EVITAR MUERTE O LESION GRAVE: NO OPERE si la cubierta de Objetos Lanzados esta dañada o falta. ● Mantenga Los Deflectores de Hule en buenas condiciones. ● Inspeccione Los Deflectores de Hule con frecuencia. Mantenga Cubierta de Objetos Lanzados </p>	<p> TO AVOID DEATH OR SERIOUS INJURY: DO NOT OPERATE if Thrown Object Shielding is damaged or missing. ● Maintain Rubber Deflectors in good condition. ● Inspect Rubber Deflectors frequently. MAINTAIN Thrown Object Shielding </p>

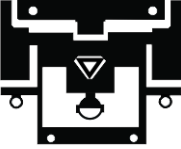

<p>PARA EVITAR INCENDIOS DE EQUIPO Y CÉSPED:</p> <ul style="list-style-type: none"> ● QUITE el césped y escombros de las líneas hidráulicas, circuito, y las cubiertas. ● NO PERMITA QUE LAS CUCHILLAS CONTACTEN piedras, metal o objetos sólidos. ● NO PERMITA QUE EL ACEITE CAIGA en el equipo o componentes calientes. <p>PARA EVITAR INCENDIOS POR IGNICIÓN:</p> <ul style="list-style-type: none"> ● NO PERMITA QUE LAS CUBIERTAS 	<p>D618 SP</p> 	<p>TO AVOID EQUIPMENT AND GRASS FIRES:</p> <ul style="list-style-type: none"> ● CLEAR AWAY grass or debris from hydraulic lines, circuits and decks. ● DO NOT ALLOW BLADES TO CONTACT rocks, metal or solid objects. ● DO NOT ALLOW OIL TO SPRAY on hot equipment or components.
<p>⚠️ WARNING ⚠️</p>		
<p>⚠️ ADVERTENCIA ⚠️</p>		

<p>PARA EVITAR MUERTE O LESION GRAVE DURANTE LA OPERACION:</p> <ul style="list-style-type: none"> ● NO levante el implemento al estar en pendientes pronunciados. ● MANTENGASE ALEJADO DE agujeros y zanjas blandas. ● SIEMPRE MANTENGA 1500 libras de contacto entre las llantas y tierra. Amplie el rodamiento de la llanta o agregue peso si es necesario. (Vea el Manual de Operadores) ● MANTENGA SIEMPRE el 20% de peso del tractor en las ruedas delanteras. ● NO comience ni acelere repentinamente. ● MANTENGA la unidad, por lo menos 10 pies de distancia de las líneas eléctricas y líneas de tubo. 	  	<p>TO AVOID DEATH OR SERIOUS INJURY DURING OPERATION:</p> <ul style="list-style-type: none"> ● DO NOT lift implement while on steep slopes. ● KEEP AWAY from soft ditch banks and holes. ● ALWAYS MAINTAIN 1500 pounds of contact between wheels and surface. Widen wheel tread or add weight if needed. (see Operator's Manual) ● ALWAYS MAINTAIN 20% of tractor weight on front wheels. ● DO NOT start or accelerate suddenly. ● KEEP mower AT LEAST 10 FEET AWAY from electric lines and pipe lines.
<p>⚠️ WARNING ⚠️</p>		
<p>⚠️ ADVERTENCIA ⚠️</p>		

<p>PARA EVITAR MUERTE O LESION GRAVE DURANTE LA TRANSPORTACION:</p> <ul style="list-style-type: none"> ● SIEMPRE ABROCHE el cinturón de seguridad. ● COLOQUE el brazo seguramente en transporte y apague el interruptor principal. ● VERIFIQUE QUE EL SMV, reflectors, y luces intermitentes de advertencia pueden ser vistos claramente por detras de la unidad. ● PRIENDA las luces intermitentes de advertencia. <p>PARA EVITAR LA PÉRDIDA DEL CONTROL DE TRANSPORTACION:</p> <ul style="list-style-type: none"> ● NO remolque en velocidades arriba de 20 mph. ● REDUZCA LA VELOCIDAD en inclinass, en vueltas y en pobres condiciones de remolque. 	  	<p>TO AVOID DEATH OR SERIOUS INJURY DURING TRANSPORTATION:</p> <ul style="list-style-type: none"> ● ALWAYS BUCKLE UP seat belt. ● PLACE boom securely in Transport Rest and turn off master switch. ● CHECK SMV sign, reflectors and warning lights for visibility behind unit. ● TURN ON tractor flashing warning lights. <p>TO AVOID LOSS OF TRANSPORTATION CONTROL:</p> <ul style="list-style-type: none"> ● DO NOT travel at speeds over 20 mph. ● REDUCE SPEED on inclines, in turns and in poor weather conditions.
<p>⚠️ WARNING ⚠️</p>		
<p>⚠️ ADVERTENCIA ⚠️</p>		

SEGURIDAD

SEGURIDAD

⚠️ ADVERTENCIA	<p>PARA EVITAR MUERTE O LESION GRAVE POR LA PENETRACION A LA PIEL POR ALTA PRESION DE ACEITE HIDRAULICO:</p> <ul style="list-style-type: none"> • NO OPERE el equipo con fugas de aceite o combustible. • MANTENGA todas las mangueras hidráulicas, líneas y conexiones en buenas condiciones y apretadas antes de aplicar presión al sistema. • Relieve la presión hidráulica antes de desconectar las líneas o trabajar en le sistema. • QUITE y reemplace la manguera si sospecha que hay fuga. <p>FUGAS DE ALTA PRESION PUEDEN SER INVISIBLE. AL VERIFICAR POR FUGAS HIDRAULICAS Y TRABAJANDO ALREDEDOR DE SISTEMAS HIDRAULICOS:</p> <ul style="list-style-type: none"> • NO use las manos para verificar si hay agujeros. • SIEMPRE USE lentes de seguridad y guantes impenetrables. • USE papel o un cartón para buscar agujeros. • NO USE las manos o partes del cuerpo para buscar agujeros. • MANTENGA manos y cuerpo LEJOS de agujeros de alfiler y boquillas que expulsan el líquido hidráulicos. 	  <p style="text-align: center;">D617 SP</p>	<p>TO AVOID DEATH OR SERIOUS INJURY FROM HIGH PRESSURE HYDRAULIC OIL LEAKS PENETRATING SKIN:</p> <ul style="list-style-type: none"> • DO NOT OPERATE equipment with oil or fuel leaks. • KEEP all hydraulic hoses, lines and connections in good condition and tight before applying system pressure. • Relieve hydraulic pressure before disconnecting lines or working on the system. • REMOVE and replace hose if you suspect it leaks. Have dealer test it for leaks. <p>HIGH PRESSURE FLUID LEAKS CAN BE INVISIBLE. WHEN CHECKING FOR HYDRAULIC LEAKS AND WORKING AROUND HYDRAULIC SYSTEMS:</p> <ul style="list-style-type: none"> • DO NOT use hands to check for leaks. • ALWAYS WEAR safety glasses with side shields (marked with ANSI Z87) and impenetrable gloves. • USE paper or cardboard to search for leaks. • KEEP hands and body AWAY from pin holes and nozzles ejecting hydraulic fluid. • Hydraulic fluid may cause gangrene if not surgically removed immediately by a doctor familiar with this form of injury.
-----------------------	---	--	--

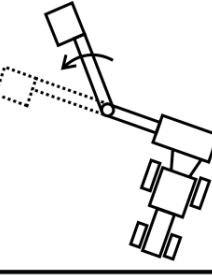
⚠️ PELIGRO		<p>KEEP AWAY</p> <p>AUTOMATIC BREAKAWAY RETURN</p> <p>Keep clear of the front of the arm and head.</p>
-------------------	---	--

D719

SEGURIDAD

SEGURIDAD

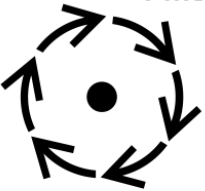
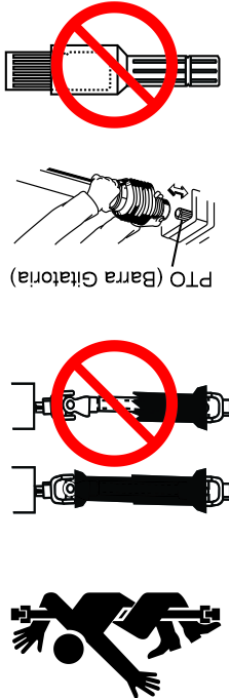
⚠ ADVERTENCIA	⚠ WARNING
<p style="text-align: center;">540 RPM</p> <p style="text-align: center;">OPERE ESTA MÁQUINA LA VELOCIDAD DE PTO (TOMA DE FUERZA O BARRA GITATORIA) DEL TRACTOR DE 540 RPM. El sobre exceso de velocidad de PTO puede causar el fracaso de componente que resultara en lesión. ROTACION DE PTO DEL TRACTOR: EN SENTIDO HORARIO <small>D547 SP</small></p>	<p style="text-align: center;">540 RPM</p> <p style="text-align: center;">OPERATE THIS MACHINE AT TRACTOR PTO SPEED ONLY. Overspeeding PTO may cause component failure resulting in bodily injury. TRACTOR PTO ROTATION: CLOCKWISE <small>D388_2</small></p> 
<p style="text-align: center;">⚠ PELIGRO</p> <p>PARA EVITAR MUERTE O LESION SERIA O POR CONTACTO A LA LINEA DE CONDUCCION, SEPARACION DE LINEA DE CONDUCCION O EL FRACASO DEL EJE DE PTO:</p> <ul style="list-style-type: none"> • PARE, MIRE y ESCUCHE por el movimiento de rotación antes de acercarse al implemento. • MANTENGASE ALEJADO y LEJOS de línea de conducción y partes girando, hasta que todos los elementos de movimiento se han parado. • SIEMPRE apague la Toma De Fuerza (Barra Gitatoria) antes de desmontar. • NO opere si las cubiertas de Toma De Fuerza (Barra Gitatoria) están dañadas. • EMPUJE Y JALE el yugo hasta que el collar de fijación hace clic y el yugo se traba en lugar. • REVISE las guardias de línea de conducción por giración libre y suficiente trasape para evitar áreas sin cobertura. • NO UTILICE UN ADAPTOR PARA LA TOMA DE FUERZA (Barra Gitatoria). <small>D547_1</small> 	<p style="text-align: center;">⚠ DANGER</p> <p>TO AVOID DEATH OR SERIOUS INJURY FROM DRIVELINE CONTACT, DRIVELINE SEPARATION OR PTO STUB SHAFT FAILURE:</p> <ul style="list-style-type: none"> • STOP, LOOK and LISTEN for rotating motion before approaching implement. • STAY AWAY and KEEP hands, feet and body AWAY from driveline & rotating parts until all moving elements have stopped. • ALWAYS shut off PTO before dismounting. • DO NOT operate if PTO shields are damaged or missing. • PUSH AND PULL on yoke until collar clicks and locks in place. • CHECK driveline guards for free rotation and sufficient overlap to avoid unshielded areas. • DO NOT USE PTO ADAPTER 

SEGURIDAD

SEGURIDAD

<p>▲ ADVERTENCIA</p> <p>TANQUE PRESURIZADO</p> <p>LA TAPA DE DEPOSITO DE PETROLEO ES LA TAPA DE ALIVIO DE PRESION.</p>	<p>▲ WARNING</p> <p>PRESSURIZED TANK</p> <p>OIL FILLER CAP IS PRESSURE RELIEF CAP</p>
<p>PARA EVITAR MUERTE O LESION GRAVE POR ESCALDADURA DE PETROLEO CALIENTE:</p> <ul style="list-style-type: none"> • MATENGASE ALEJADO del aceite caliente que puede salir a presión del tanque. • Remueva LENTAMENTE la tapa para relevar la presión ANTES de remover la tapa completamente. • PERMITA que el petróleo se enfríe ANTES de remover la tapa. <p>D625 SP</p>	<p>TO AVOID DEATH OR SERIOUS INJURY FROM HOT OIL:</p> <ul style="list-style-type: none"> • STAY AWAY from hot oil that may spray out of tank. • ALLOW oil to cool down BEFORE removing cap. • SLOWLY remove cap to relieve pressure BEFORE removing completely.

<p>▲ WARNING</p>	<p>PINCH POINTS</p> <p>D623</p> <p>ADVERTENCIA</p> <p>PUNTO DE PELIZCO</p>

<p>▲ DANGER</p> <p>CRUSHING HAZARD AND PINCH POINTS</p>	
<p>TO AVOID DEATH OR SERIOUS INJURY:</p> <ul style="list-style-type: none"> • KEEP AWAY from moving machinery parts that can pinch, crush or fall. 	<p>RIESGOS DE AFLASTAMIENTO Y PUNTOS DE PELIZCO</p> <p>PARA EVITAR MUERTE O LESION GRAVE:</p> <ul style="list-style-type: none"> • MANTENGASE ALEJADO de piezas móviles de la máquina que pueden peliscar, aplastar o caerse. <p>D628 SP</p>

<p>▲ WARNING</p>	<p>TO AVOID INJURY OR EQUIPMENT DAMAGE:</p> <p>Make certain stabilizers and sway blocks are positioned to stabilize boom and prevent sideways motion.</p>
<p>▲ ADVERTENCIA</p>	
<p>PARA EVITAR LESION SERIA O DAÑO AL EQUIPO:</p> <ul style="list-style-type: none"> • Asegúrese de que los estabilizadores y los bloques estabilizadores están en posición para estabilizar el brazo y prevenir el movimiento lateral. D716 	

SEGURIDAD

SEGURIDAD





<p>! PELIGRO</p>			
		 <p>www.algqr.com/bbs</p>	
<p>PARA EVITAR MUERTE O LESION GRAVE:</p> <ul style="list-style-type: none"> ● LEA Y ENTIENDA el Manual de Operador proporcionado, signos de seguridad y calcomanías informativas para el tractor y implemento antes de operar el equipo. ● CONTACTE AL DISTRIBUIDOR inmediatamente si no tiene los manuales. ● CONTACTE AL DISTRIBUIDOR para que le explique cualquier instrucciones que no entienda completamente. ● SIEMPRE USE lentes de seguridad con protectores laterales (marcados para cumplir con ANSI Z87). ● USE un casco, zapatos de seguridad y guantes para su protección cuando esta operando el equipo. 			
<p>! DANGER</p>			
		 <p>www.algqr.com/bbe</p>	
<p>TO AVOID DEATH OR SERIOUS INJURY:</p> <ul style="list-style-type: none"> ● READ AND UNDERSTAND the provided Operator's Manuals, safety signs and information decals for tractor and implement before operating equipment. ● CONTACT DEALER immediately if you do not have manuals. ● CONTACT DEALER to explain any instructions not fully understood. ● ALWAYS WEAR safety glasses with side shields (marked with ANSI Z87). ● WEAR hard hat, safety shoes and gloves for protection when operating equipment. 			

D823 SP 5

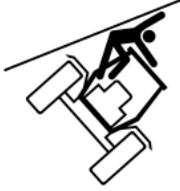
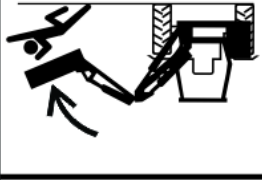
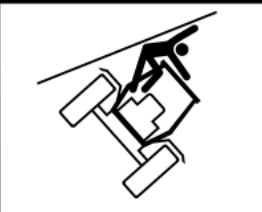
SEGURIDAD

SEGURIDAD

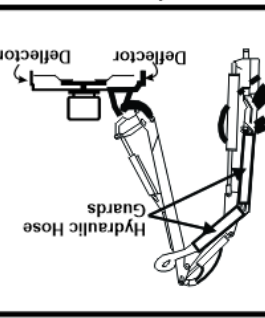
		<p>Riesgo de Aplastamiento - Muerte o Lesion</p> <p>! PELIGRO</p>
<p>PARA EVITAR MUERTE O LESION GRAVE:</p> <ul style="list-style-type: none"> ● USE un tractor equipado con Estructura Protectora Contra Vueltos ("ROPS") incluyendo barra antivuelco y cinturón de seguridad. Mantenga la barra antivuelco en la posición elevada. ● Despeje el área de personas presentes antes de bajar o subir la cortadora. ● EL IMPLEMENTO SE PUEDE CAER por el mal funcionamiento hidráulico o operación accidental de los controles. ● BLOQUEE y soporte con seguridad el equipo antes de poner manos, pies o cuerpo debajo del equipo o componentes levantados. 		
<p>Crushing Hazard - Death or Injury</p>		<p>! DANGER</p>
<p>TO AVOID DEATH OR SERIOUS INJURY:</p> <ul style="list-style-type: none"> ● USE tractor equipped with Rollover Protective Structure ("ROPS") including roll bar and seat belt. Keep roll bar in raised position. ● CLEAR AREA of bystanders before raising or lowering mower. ● IMPLEMENT CAN FALL from hydraulic failure or accidental operation of controls. ● BLOCK UP and securely support equipment before putting hands, feet or body under raised equipment or lifted components. 		
<p>Crushing Hazard - Death or Injury</p>		<p>! DANGER</p>

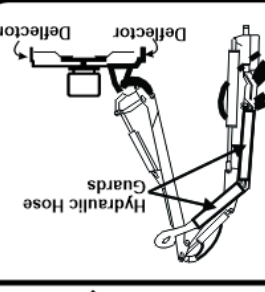
	<p>PELIGRO</p> <p>RIESGO DE ENREDAMIENTO</p>
	<p>PARA EVITAR MUERTE O LESION GRAVE:</p> <ul style="list-style-type: none"> ● NO opere sin la cubierta protectora en su lugar y en buen estado. Toma De Fuerza (Barra Gritatoria) y guardias de caja de engranaje son SUJETO AL ESGASTE. ● MANTENGASE ALEJADO y MANTENGA manos, pies y cuerpo LEJOS de las cuchillas girando, líneas de conducción, y partes que siguen moviéndose después de que el poder es apagado. ESPERE hasta que todos los elementos móviles se han parado. ● SIEMPRE REEMPLACE CUBIERTAS que han sido quitadas para servicio o mantenimiento. ● DETENGASE, OBSERVE y ESCUCHE por el movimiento de rotación antes de acercarse al implemento.
	<p>DANGER</p> <p>ENTANGLEMENT HAZARD</p>
	<p>TO AVOID DEATH OR SERIOUS INJURY:</p> <ul style="list-style-type: none"> ● DO NOT operate without guards in place and in good condition. PTO and gearbox guarding are SUBJECT TO WEAR. ● STAY AWAY and KEEP hands, feet and body AWAY from rotating blades, drivelines and parts that continue to move after power shut-off. WAIT until all moving elements have stopped. ● ALWAYS REPLACE GUARDS that have been removed for service or maintenance. ● STOP, LOOK and LISTEN for rotating motion before approaching implement.
	<p>D823 SP 3</p>

SEGURIDAD

SEGURIDAD

PELIGRO

Riesgo de Atropello Lesión o Muerte

PARA EVITAR MUERTE O LESION GRAVE:

- SIEMPRE ABROCHE el cinturón de seguridad.
- SOLO ENCIENDA el tractor mientras que esta sentado en el asiento del operador.
- PARE EL MOTOR Y Toma De Fuerza (Barro Gítoria), aplique el freno de mano, baje el implemento, y deje que todas las partes movi paren completamente, y quite la llave antes de desmontar el tractor.
- ENTIENDA COMO parar el tractor y equipo rápidamente en caso de una emergencia.
- NO MONTE o DESMONTE el tractor en movimiento.
- NUNCA PERMITA pasajeros en el tractor o implemento.
- NUNCA PERMITA que niños operen o se monten en el tractor o implemento.
- MANTENGA LAS PERSONAS PRESENTES LEJOS de la area antes de mover el tractor o implemento.
- MANTENGASE ALERTO y EVITE golpes en troncos, agujeros, pozos o terreno en desnivel.
- EVITE las ramas de árbol, maleza y algun otros objetos que sobresalen que puedan golpear y tumbar el operador del asiento.

DANGER

Run Over Hazard - Death or Injury

TO AVOID DEATH OR SERIOUS INJURY:

- ALWAYS BUCKLE UP seat belt.
- ONLY START Tractor while seated in the operator's seat.
- STOP ENGINE and PTO, engage parking brake, lower implement, allow all moving parts to stop and remove key before dismounting from tractor.
- KNOW HOW to stop tractor and equipment quickly for an emergency.
- DO NOT MOUNT or DISMOUNT Tractor in motion.
- NEVER ALLOW riders on tractor or implement.
- NEVER ALLOW children to operate or ride on tractor or implement.
- KEEP BYSTANDERS CLEAR of area before moving tractor or implement.
- KEEP ALERT and AVOID hitting stumps, holes, ruts, and uneven terrain.
- AVOID tree limbs, brush and other overhanging objects that can strike and throw the operator from seat.

D823 SP 2



RMB 1445 08/22

Sección de Seguridad 1-17

SEGURIDAD

DESCRIPCIÓN DE CALCOMANÍA

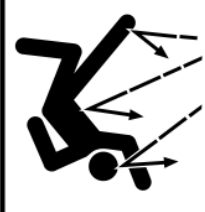
⚠ PELIGRO

RIESGO DE OBJETOS LANZADOS

MUERTE O LESION GRAVE a operadores y personas presentes: PARA EVITAR Cortacésped puede lanzar objetos hasta 300 pies. PARA EVITAR

- Pare de segar si personas o tráfico se acercan entre 300 pies del área de segar.
- NO OPERE sin la cubierta para objetos lanzados.
- MANTENGA la cubierta para objeto lanzado en su lugar y en buenas condiciones. Los protectores de objetos lanzados son sujetos al desgaste.
- REPARÉ O REEMPLAZÉ cubiertas si son dañadas, quebradas, o si faltan.
- INSPECCIONE el área por si hay riesgos potenciales de objetos lanzados antes de segar:
- REMUEVA y EVITE objetos como alambre, cable, objetos de metal y todo otro material extraño.
- NO DEJE que las cuchillas contacten los objetos sólidos como alambre, rocas, postes, borde de banqueta, o barandillas.
- NO OPERE en posición de transporte o con las alas levantadas.

⚠ DANGER

THROWN OBJECTS HAZARD

Mower can throw objects up to 300 feet. TO AVOID DEATH OR SERIOUS INJURY to operator or bystanders:

- STOP mowing if bystanders or traffic come within 300 feet.
- DO NOT OPERATE with thrown object shielding removed.
- KEEP thrown object shielding in place and in good condition during operation. Thrown Objects shielding is subject to wear.
- REPAIR OR REPLACE shielding if damaged, broken or missing. See Operator's Manual for all Shields and Guards.
- INSPECT area for potential mower thrown object hazards before mowing.
- Remove and AVOID objects such as wire, cable, metal objects and all other foreign material.
- DO NOT ALLOW blades to contact solid objects like wire, rocks, posts, curbs or guard rails.
- DO NOT operate without operate protective shielding or cab

D823 SP 1

SEGURIDAD

SEGURIDAD

INFORMACIÓN DE PARTES

Las cortadoras BUSH HOG usan balanceadas y componentes de sistema seleccionado para los portadores de cuchillas, cuchillas, eje de cortar, navaja, suspensiones de navajas, los rodillos, los componentes de línea motriz, y cojinetes. Estas partes son echas y probadas a la especificaciones de BUSH HOG. Partes que no son auténticas no regularmente llegan con estas especificaciones. El uso de partes que no son auténticas puede reducir el funcionamiento de la cortadora, anular garantías, y presentar un peligro de seguridad. Use partes de cortadora auténticas de BUSH HOG por economía y seguridad. (SPBH-1 SP) str

CONTACTE A SU DISTRIBUIDOR BUSH HOG

Manuales de Partes Y Operador



www.algqr.com/bpm





NOTA: Si necesita un manual completamente en español por favor de ponerse en contacto a: *Translations, direccion 1502 E. Walnut Street Seguin, TX 78155; Fax: (830) 372-9529*

RMB 1445 08/22

Sección de Seguridad 1-15

SEGURIDAD

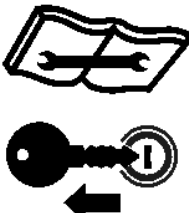
RIESGOS CON EL MANTENIMIENTO DEL IMPLEMENTO

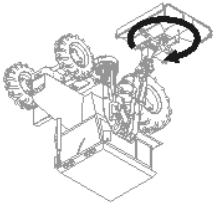
 <p>Inspeccione periódicamente todas las partes móviles, lubrique las líneas de conducción y ajuste todas las sujeciones.</p>	<p>Baje el cabezal de la cortadora hasta el suelo o bloquéelo antes de repararlo.</p> 	<p>Apague el motor. Quite la llave antes de realizar tareas de mantenimiento.</p> 	<p>Baje el cabezal a una posición segura sobre el suelo antes de reparar las cuchillas.</p> 	<p>Riesgo de objetos arrojados por la cortadora. Asegúrese de que las cuchillas giren en sentido horario visto desde arriba del cabezal de la cortadora.</p> 
--	--	---	---	--

ADVERTENCIA

MANTENGA LOS IMPLEMENTOS EN BUENAS CONDICIONES DE FUNCIONAMIENTO, A TRAVÉS DE UN SERVICIO, REPARACIÓN O MANTENIMIENTO APROPIADO.

ANTES DE REALIZAR TAREAS DE SERVICIO, REPARACIÓN Y MANTENIMIENTO DEL IMPLEMENTO:
APAGUE EL MOTOR Y EL PTO, coloquese el freno de mano, descienda el implemento, espere a que se detengan todas las partes móviles y quite la llave antes de bajarse del tractor.
COLOQUE el implemento sobre el suelo o trabe de manera segura los equipos elevados. Utilice bloques grandes sobre suelo blando o húmedo.
EMPUJE Y JALE la palanca del Cilindro Hidráulico Remoto para liberar la presión hidráulica.
DESCONECTE la Válvula de solenoide de la bomba o la conexión de la línea de conducción de la TDF de antes de reparar el cabezal de la cortadora.

USE GAFAS DE SEGURIDAD Y GUANTES PROTECTORES y siga todos los PROCEDIMIENTOS DE SEGURIDAD al realizar tareas de servicio, reparación y mantenimiento sobre el implemento.
 Siempre **USE GUANTES** protectores al manipular las hojas, cuchillas, bordes filosos o un componente desgastado con bordes filosos.
 Siempre **USE GUANTES Y GAFAS DE SEGURIDAD** al reparar componentes en caliente.
EVITE EL CONTACTO con tanques de aceite hidráulico, bombas, motores, válvulas y superficies de conexión de mangueras calientes.

SUJETE FIRMEMENTE o **TRABE EN POSICIÓN ELEVADA** todos los implementos, bastidores y componentes elevados antes de trabajar sobre los equipos que se encuentran debajo.
SIGA LAS INSTRUCCIONES de la sección de mantenimiento al reemplazar los cilindros hidráulicos para evitar la caída de componentes.
DETENGA el movimiento de todos los implementos y **APAGUE EL MOTOR DEL TRACTOR** antes de realizar ninguna tarea. **USE** una escalera o gradas elevadas para alcanzar áreas altas del equipo a las que no se pueda acceder desde la tierra. **ASEGURESE** de estar bien apoyado sobre superficies sólidas planas al subirse al implemento para realizar tareas. **SIGA** las instrucciones del fabricante sobre cómo manipular los lubricantes, solventes, limpiadores y otros agentes químicos. **NO** cambie ninguna calibración hidráulica de fábrica para evitar fallas de los componentes o equipos.
NO modifique o altere el implemento, las funciones o componentes.
NO suelde o repare los componentes de la cortadora. Esto puede causar vibraciones y fallas de los componentes que se desprendan de la cortadora.

REALICE LAS TAREAS DE SERVICIO, REPARACIÓN, LUBRICACIÓN Y MANTENIMIENTO QUE SE DESCRIBEN EN LA SECCIÓN DE MANTENIMIENTO DEL IMPLEMENTO:
INSPECCION el implemento para detectar sujeciones sueltas, partes gastadas o rotas, ajustes sueltos o con filtraciones, que los pasadores tengan chavetas y arandelas, y las partes móviles para detectar el desgaste.
REEMPLACE todas las partes gastadas o rotas con repuestos autorizados.
 Inspeccione el huso de la cuchilla de la cortadora para asegurar la carga previa de los rodamientos. Si está suelto, repárelo antes de operar.
LUBRIQUE la unidad tal como se especifica en el cronograma de lubricación.
NUNCA lubrique, ajuste o quite material mientras el equipo está en funcionamiento o movimiento.
AJUSTE todas las tuercas y pernos tal como se especifica.
INSPECCIÓN DE CUCHILLAS:
 Inspeccione el soporte de la cuchilla y las cuchillas a diario.
 Inspeccione el ajuste de los PERNOS del soporte de la cuchilla y las cuchillas a diario. Los pernos sueltos pueden causar fallas de la cuchilla o del perno de la cuchilla.
REEMPLACE las cuchillas dobladas, dañadas, agrietadas o rotas inmediatamente por cuchillas nuevas.
EVITE fallas de las cuchillas y que vuelen trozos de cuchillas. **NO** enderece, suelde o suelde con superficies rígidas. **INSPECCIÓN DE PROTECTORES DE SEGURIDAD, GUARDAS Y DISPOSITIVOS DE SEGURIDAD:**
MANTENGA en su lugar y en buen estado todos los deflectores, protectores de cadena, protectores de acero, cubiertas de caja de engranajes, cubiertas integrales de PTO, bandas, faldones laterales y zapatas antideslizantes.

ADVERTENCIA

Cáncer y daño reproductivo www.P65Warnings.ca.gov. PN HMBM-01 SPstr

SEGURIDAD

SEGURIDAD

RIESGOS EN TRANSPORTE

		
Use señales de SMV (vehículo de movimiento lento) y balizas	Riesgo de pérdida de control al detenerse	Riesgo de pérdida de control al acelerar

ADVERTENCIA PARA EVITAR LESIONES GRAVES O LA MUERTE AL REMOLCAR O TRANSPORTAR EQUIPOS:

- **MANTENGA** la velocidad de transporte **POR DEBAJO DE 20** millas por hora para mantener el control del equipo.
- **REDUZCA LA VELOCIDAD** en terreno inclinado, en las curvas y en condiciones de remolque desfavorables.
- **NO REMOLQUE** camiones u otros vehículos
- **USE** un tractor de tamaño adecuado y equipado en función del equipo de remolque.
- **SIGA** todas las reglamentaciones de tránsito locales.
- **REQUISITOS DEL TRACTOR PARA REMOLCAR O TRANSPORTAR IMPLEMENTOS:**
- **SOLO TRANSPORTE** en el tractor con el mecanismo **ROPS** (antivuelco) en posición elevada.
- **USE** un tractor de tamaño adecuado y equipado, que supere el peso del implemento en al menos un 20%
- **MANTENGA EL 20%** del peso del tractor en las ruedas frontales para mantener la dirección en forma segura.
- **ANTES DE TRANSPORTAR O REMOLCAR EL IMPLEMENTO:**

- **INSPECCIÓN DEL TRACTOR:**
- **VERIFIQUE** la dirección y los frenos para asegurarse el correcto funcionamiento y las condiciones adecuadas.
- **VERIFIQUE LLEVAR EL AVISO DE SMV**, los reflectores y las luces de advertencia para la adecuada operación y visibilidad detrás de la unidad.
- **VERIFIQUE** que no haya impedimentos a la visión mientras conduce, en el tractor, la cabina o el implemento, sentado en el asiento del tractor.
- **AJUSTE** su posición de conducción, los espejos y el transporte del implemento para tener una visión clara para condiciones de conducción y tránsito.
- **PREPARE EL IMPLEMENTO PARA EL TRANSPORTE O EL REMOLQUE:**
- **GUARDE** el brazo y la cortadora en posición de transporte y conecte las tabas de transporte si existen.
- **DETERMINAR LAS CARACTERÍSTICAS DE DETENCIÓN DEL TRACTOR Y EL IMPLEMENTO PARA EL TRANSPORTE O REMOLQUE:**
- **PRUEBAS DE FRENADO:**
- La distancia de frenado puede aumentar con el implemento conectado
- Observe las distancias de **DETECCIÓN** con el aumento de velocidad.
- **DETERMINE** la velocidad de transporte máxima segura que no supere las 20 millas por hora
- Reduzca la velocidad en caminos mojados o cubiertos de hielo; las distancias de frenado aumentan.
- **DETERMINE LA VELOCIDAD DE GIRO MÁXIMA ANTES DE OPERAR EN CARRETERAS O TERRENO IRREGULAR:**
- **PONGA A PRUEBA** el equipo aumentando lentamente la velocidad en las curvas para determinar si se puede operar a mayor velocidad.
- **USE MENORES** velocidades de giro en las curvas pronunciadas para evitar el vuelco.
- **AL REMOLCAR O TRANSPORTAR EL EQUIPO:**
- Siempre **USE EL CINTURÓN DE SEGURIDAD** al operar o transportar la cortadora.
- **USE** bajas velocidades para evitar el vuelco con el implemento elevado.
- **USE** bajas velocidades y dirección gradual en las curvas, colinas, o en superficies irregulares o poco uniformes, y en carreteras mojadas.
- **ENCIENDA LAS BALIZAS DE ADVERTENCIA** del tractor.
- **TENGA EN CUENTA** el espacio necesario para el vaivén del implemento en las curvas.
- **MANTENGA** el brazo y cortadora elevadas a 3 metros (10 pies) o una mayor distancia de todos los cables de alimentación y obstrucciones elevadas. *PN THBM-01 SP str*

RMB 1445 08/22 Sección de Seguridad 1-13

SEGURIDAD

SEGURIDAD

RIESGOS ELÉCTRICOS Y DE FUEGO

		
<p>Cabezal o brazo en contacto con cables eléctricos elevados</p>	<p>Riesgo de choque y explosión Contacto de paletas con líneas de servicios o gas</p>	<p>Riesgo de incendio. No opere cerca de fuego. Mantenga los residuos legos de las válvulas y las bombas hidráulicas.</p>

▲ PELIGRO PARA EVITAR LESIONES GRAVES O LA MUERTE POR CONTACTO ELÉCTRICO AL TRABAJAR CERCA DE CABLES ELÉCTRICOS, LÍNEAS DE GAS Y DE SERVICIOS:

- **INSPECCION** el área de corte para que no interfiera con cables de alimentación eléctricos subterráneos, obstrucciones, líneas de gas, cables y servicios, estructuras municipales o de otro tipo.
- **MANTENGA** todas las alas elevadas a 3 metros (10 pies) o una mayor distancia de todos los cables de alimentación y obstrucciones elevadas.
- **NO** ponga en contacto la cortadora con ninguna estructura u obstrucción de servicios o municipales.
- **LLAME** AL 811 y al 1-800-258-0808 para identificar cables de servicios subterráneos.

PAUTAS DE PREVENCIÓN DE INCENDIOS durante la operación, reparación y servicio de la cortadora y el tractor, a fin de reducir el riesgo de incendio del equipo y de la vegetación:

- El tractor debe estar **EQUIPADO CON MATAFUEGOS**
- **NO OPERE** la cortadora sobre un tractor equipado con escape debajo del bastidor
- **NO FUME** ni acerque fuego directo a la cortadora o el tractor
- **NO CONDUZCA** sobre residuos encendidos o en áreas recientemente quemadas
- **EVITE LA FORMACIÓN DE CHISPAS** al no permitir que la hoja de la cortadora entre en contacto con objetos sólidos como metal o roca.
- **NO OPERE** el equipo con filtraciones de aceite o combustible. Repare cualquier filtración de aceite y retire el aceite acumulado antes de operar.
- **LIMPIE** todo resto de hierba o residuo acumulado alrededor de las líneas de conducción de la cortadora, los embragues deslizantes y cajas de cambios.
- **APAGUE EL MOTOR** al cargar combustible *PN EFBM-01 SPstr*

SEGURIDAD

RIESGO DE FILTRACION DE ACEITE HIDRÁULICO DE ALTA PRESIÓN

	Penetración de aceite de alta presión en la piel
	Erosión de la piel por el aceite de alta presión
	Usar cartón para detectar filtraciones de aceite
	Los contenidos del tanque están bajo presión. Permita que el aceite se enfríe antes de quitar la tapa.

▲ PELIGRO

PARA EVITAR LESIONES GRAVES O LA MUERTE POR PENETRACIÓN DE FILTRACIONES DE ACEITE HIDRÁULICO DE ALTA PRESIÓN:

- **NO OPERE** el equipo con filtraciones de aceite o combustible.
- **MANTENGA** todas las mangueras hidráulicas, líneas y conexiones en **BUEN ESTADO** y **AJUSTADAS** antes de aplicar presión al sistema.
- **LIBERE LA PRESIÓN HIDRÁULICA** antes de desconectar las líneas o trabajar en el sistema.
- **QUITTE** y reemplace la manguera si sospecha que tiene filtraciones. Solicite al distribuidor que verifique si hay filtraciones.

LAS FILTRACIONES DE LÍQUIDO DE ALTA PRESIÓN PUEDEN NO SER VISIBLES.

AL VERIFICAR FILTRACIONES HIDRÁULICAS Y TRABAJAR CERCA DE LOS SISTEMAS HIDRÁULICOS:

- **SIEMPRE USE** gafas de seguridad y guantes impermeables.
- **USE** papel o cartón para verificar si hay filtraciones.
- **NO USE** las manos o partes del cuerpo para detectar filtraciones.
- **MANTENGA** las manos y el cuerpo **LEJOS** de los orificios de clavijas y boquillas de eyección de fluido hidráulico.
- El fluido hidráulico puede causar gangrena si no es extirpado quirúrgicamente de inmediato por un médico especializado en este tipo de lesiones.





Tenga cuidado cuando retire la tapa del tanque hidráulico.

- Los contenidos del tanque pueden estar bajo presión.
- Siempre permita que el aceite se enfríe antes de quitar la tapa.
- Libere la presión de aceite antes de retirar la tapa lentamente.
- Alejese del aceite caliente que pueda rociarse desde el tanque. *PN HPBM-01 Spstr*

SEGURIDAD

SEGURIDAD

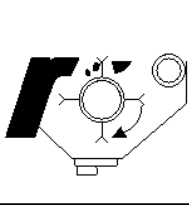
RIESGO DEL CONTACTO A LAS CUCHILLAS DE CORTADORA

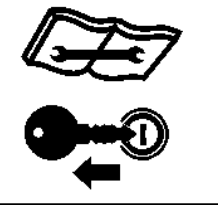

	No ponga los dedos debajo de la cortadora
	No ponga las manos debajo de la cortadora trituradora
	No ponga el pie debajo de la cortadora
	No ponga el pie debajo de la cortadora trituradora
	Riesgo de cizallamiento por las cuchillas de hoz
	Detenga el tractor. Quite la llave. Lea el Manual

▲ PELIGRO MANTÉNGASE LEJOS DE LAS CUCHILLAS GIRATORIAS PARA EVITAR LESIONES GRAVES O LA MUERTE POR CONTACTO CON LA CUCHILLA:

- MANTÉNGASE LEJOS y NO ACERQUE LAS MANOS, LOS PIES y EL CUERPO a las cuchillas giratorias, líneas de conducción y partes hasta que todos los elementos móviles se hayan detenido.
- NO ponga las manos o los pies debajo de las plataformas de la cortadora
- DETENGA las CUCHILLAS giratorias, desconecte el interruptor de la cortadora y la TDF (PTO) y espere que la cuchilla deje de girar antes de levantar el cabezal de la cortadora.
- NO se acerque el cabezal de la cortadora de hoz hasta que el motor del tractor haya sido apagado.
- DETENGA la cortadora, EXAMÍNELA Y PRESTE ATENCIÓN A LOS SONIDOS antes de acercarse a la cortadora para asegurarse de que se haya detenido todo el movimiento giratorio. *PN MBM-01 SPstr*

SEGURIDAD

RIESGO DE ENREDO POR EL PTO

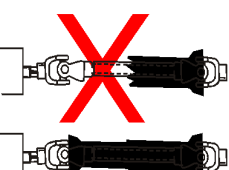
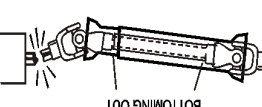
<p>Peligro de enredo No se acerque o toque ningún eje de transmisión de PTO giratorio</p>	
<p>Asegúrese de que el eje de PTO esté firmemente sujeto. No use un adaptador de PTO</p>	<p>PTO (Barra Giratoria)</p> 
<p>No opere la máquina si las cubiertas de PTO están dañadas o faltantes</p>	
<p>Asegúrese de que los ejes de PTO sean del largo adecuado</p>	

⚠ PELIGRO MANTÉNGASE ALEJADO DE LAS LÍNEAS DE CONDUCCIÓN Y OTROS ELEMENTOS GIRATORIOS PARA EVITAR LESIONES GRAVES O LA MUERTE:

MANTÉNGASE LEJOS Y NO ACERQUE las manos, los pies y el cuerpo a las cuchillas giratorias, líneas de conducción y partes hasta que todos los elementos móviles se hayan detenido.
DETENGA la cortadora, **EXAMÍNELA Y PRESTE ATENCIÓN A LOS SONIDOS** antes de acercarse a la cortadora para asegurarse de que se haya detenido todo el movimiento giratorio.
LOS ELEMENTOS GIRATORIOS SIGUEN ROTANDO una vez apagada la PTO.

PROTECCIÓN DE LA PTO:

PARA EVITAR LESIONES GRAVES O LA MUERTE POR ENREDO AL OPERAR EL IMPLEMENTO:
MANTENGA instalados los protectores, las cubiertas integrales de las líneas de conducción y las cubiertas de entrada **NO OPERE** la cortadora si los protectores o cubiertas no están bien colocados o faltan.
REEMPLACE O REPARÉLOS si faltan, están dañados o rotos
SIEMPRE REEMPLACE LOS PROTECTORES que se han quitado para tareas de reparación o mantenimiento.
PARA EVITAR que la línea de conducción se rompa durante las operaciones:

VERIFIQUE que la línea de conducción tenga el largo adecuado entre el eje de PTO y el eje de la caja de cambios del implemento.
 Las líneas de conducción demasiado cortas se pueden soltar o romper.
 Las líneas de conducción demasiado largas pueden tocar el suelo.
 Un ensamble telescópico de la línea de conducción que toque el suelo no se deslizará y se solidificará.
 Si la línea de conducción toca el suelo, puede atravesar los cojinetes de soporte y romper el eje de PTO.
EVITE hacer curvas pronunciadas o elevar la cortadora a alturas que puedan hacer caer la línea de conducción.
 Lubrique los componentes telescópicos del eje de transmisión en forma semanal.
COMUNÍQUESE CON EL DISTRIBUIDOR si la línea de conducción del implemento no coincide con el eje de PTO del tractor:

NO UTILICE UN ADAPTADOR DE PTO.

El uso de un adaptador de PTO puede causar vibración excesiva, caída de objetos, fallas de las cuchillas y el implemento como consecuencia de la duplicación de la velocidad operativa. El aumento de la longitud de trabajo puede exponer áreas desprotegidas de la línea de conducción. *PN PE01 SPst*

SEGURIDAD

SEGURIDAD

RIESGO DE ATROPELLO

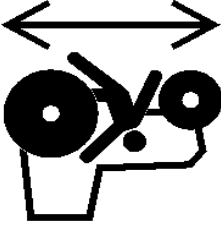
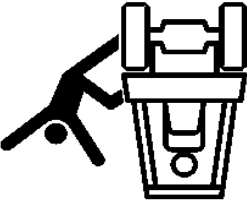
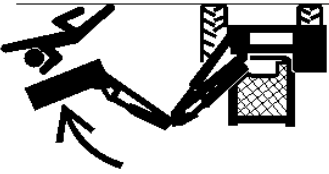



		
Riesgo de atropello del operador	Riesgo de atropello por caída del operador	Riesgo de atropello de personas presentes

▲ PELIGRO PARA EVITAR LESIONES GRAVES O LA MUERTE POR CAIDA DEL TRACTOR O ATROPELLO DEL EQUIPO:

- USE tractores equipados con **SISTEMA ANTIVUELCO (ROPS)** y **CINTURONES DE SEGURIDAD** para las operaciones de corte.
- **MANTENGA EL SISTEMA ROPS** trabado en posición vertical.
- **SÓLO ENCIENDA** el tractor sentado en el asiento del tractor.
- **SIEMPRE ABRÓCHESE** el cinturón de seguridad al operar el tractor y los equipos.
- **SÓLO OPERE** el tractor y el equipo sentado en el asiento del tractor.
- **NUNCA LLEVE A OTRAS PERSONAS** en el tractor o implemento.
- Cuando no esté cortando, coloque el brazo y el cabezal de la cortadora en el espacio de transporte antes de moverse.
- **AL SUBIR Y BAJAR DEL TRACTOR:**
 - **SÓLO** suba o baje del tractor cuando éste y sus partes móviles estén detenidos.
 - **APAGUE EL MOTOR Y LA TDF**, coloque el freno de mano, descienda del implemento, espere a que se detengan todas las partes móviles y quite la llave antes de bajarse del tractor. *PN ROB-M-01 Spstr*

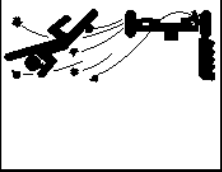
SEGURIDAD

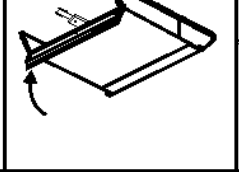
RIESGO DE OBJETOS LANZADOS CONTINUADO

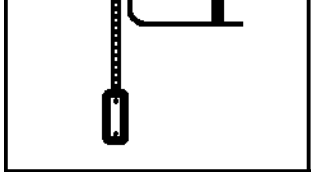
 <p>Peligro de objetos lanzados por la cortadora</p>	 <p>Objetos lanzados desde cortadora elevada</p>	 <p>Mantenga la puerta de la cortadora cerrada si el tráfico se encuentra al menos de 300 pies</p>	 <p>Inspeccione el área. Quite los objetos extraños</p>	 <p>No permita que las cuchillas entren en contacto con objetos sólidos</p>
---	--	---	--	--

OPERACIÓN DE LA CORTADORA:





- **NO** exceda la capacidad de corte nominal de la cortadora, ni corte elementos que no sean vegetación.
- **USE CABINAS DE TRACTOR CERRADAS** cuando haya dos o más cortadoras operando en un mismo sector.
- No opere la cortadora en áreas susceptibles al ataque de abejas o insectos, salvo que **USE PRENDAS PROTECTORAS** o una cabina de tractor cerrada.
- **AJUSTE LA ALTURA PARA EVITAR EL CONTACTO DE LAS CUCHILLAS** con objetos sólidos, como alambres, piedras, postes, cordones, guardarrailles y obstrucciones fijas.
- **CIERRE** la puerta de la cortadora y detenga la operación si se acercan transeúntes a 100 metros (300 pies) a la redonda de la cortadora.
- Mantenga la puerta de la cortadora cerrada cuando corte cerca del suelo.
- Abra la puerta sólo para cortar ramas grandes de arbustos o árboles. Cierre la puerta inmediatamente después de cortar la rama.
- **NO** empuje el cabezal de la cortadora hacia abajo sobre el material para cortarlo, use las puntas frontales de las cuchillas de la cortadora para cortar el material.
- **NO** opere la cortadora cuando la cortadora esté en posición de transporte.
- **DETENGA LA CORTADORA** de inmediato si las cuchillas entran en contacto con objetos pesados, estructuras fijas, guardarrailles de metal y estructuras de cemento.
- **LAS CUCHILLAS PUEDEN FALLAR** con el impacto y los objetos pueden ser arrojados a gran velocidad.
- **INSPECCIONE Y REEMPLACE** las cuchillas dañadas.
- **VERIFIQUE** el equilibrio del porta cuchillas y **REEMPLACELO** si está dañado.
- **NO** opere la cortadora en agua **PARA EVITAR** una posible **FALLA DE LAS CUCHILLAS**.
- **EVITE OPERAR LA CORTADORA** en reversa.
- **1. DETENGA EL PTO** y retroceda la cortadora.
- **2. DESCienda** la cortadora, encienda el **PTO** y corte hacia adelante.
- **DESCONECTE** el cabezal de la cortadora y espere hasta que las **CUCHILLAS** dejen de rotar antes de levantar la cortadora a la posición de transporte.
- **NO ENCIENDA EL PTO** con la cortadora en posición de transporte.
- **DETENGA** la cortadora cuando se produzca **VIBRACIÓN EXCESIVA**:
- **1. DETENGA EL PTO Y EL MOTOR** del tractor.
- **2. INSPECCIONE** la cortadora para detectar la fuente de la vibración
- **3. REEMPLACE** toda parte dañada o las **CUCHILLAS** dobladas o dañadas. *PN TOBM-02 SPStr*

RMB 1445 08/22

Sección de Seguridad 1-7

SEGURIDAD

RIESGO DE OBJETOS LANZADOS

	Peligro de objetos lanzados por la cortadora
	Objetos lanzados desde cortadora elevada
	Mantenga la puerta cerrada si el tráfico se encuentra al menos de 300 pies
	Inspeccione el área. Quite los objetos extraños
	No permita que las cuchillas entren en contacto con objetos sólidos

⚠ PELIGRO LAS CORTADORAS GIRATORIAS PUEDEN ARROJAR OBJETOS A 90 METROS (300 PIES) O MÁS EN CONDICIONES ADVERSAS.

PARA EVITAR LESIONES GRAVES O LA MUERTE AL OPERADOR O TRANSEÚNTES COMO CONSECUENCIA DE OBJETOS ARROJADOS:

- **MANTENGA** a los transeúntes a 100 metros de distancia (300 pies)
- **NO OPERE LA CORTADORA SI HAY PERSONAS A MENOS DE 100 METROS(300 PIES), SALVO QUE:**

Todos los **PROTECTORES CONTRA OBJETOS ARROJADOS** estén colocados y en buen funcionamiento al operar la cortadora, entre los que se incluyen los deflectores frontales y traseros, los protectores de cadena, los protectores de acero, las bandas, los fal-

• El Cabezal de la cortadora esta ajusta cerca y paralela al suelo, sin exponer las cuchillas.

• Se ha inspeccionado el **ÁREA DE CORTE** y se han quitado todos los materiales extraños y residuos.

• Los **TRANSEÚNTES** estén en el interior de un vehículo cerrado.

• **ANTES DE OPERAR LA CORTADORA, INSPECCIONE EL ÁREA PARA DETECTAR LA POSIBILIDAD DE OBJETOSQUE PUEDAN SER LANZADOS:**

• **QUITTE** residuos, piedras, cables, alambres, objetos metálicos y cualquier otro objetos extraños del área.

• Los alambres, cables, sogas, cadenas y objetos metálicos pueden ser arrojados o salir desprendidos de la plataforma a gran velocidad:

• **No permita** que las cuchillas de la cortadora entren en contacto con cadáveres de animales en descomposición o otros materiales peligrosos. Las cuchillas de la cortadora podran arrojar materiales peligrosos y biológicos de la cortadora, exponiendo al operador y

• retire material potencialmente peligroso de equipo.

1. **MARQUE** los objetos que no se puedan quitar.

2. **EVITE** estos objetos cuando use la cortadora.

INSPECCIÓN DEL ÁREA PARA DETECTAR HIERBA ALTA Y MALEZAS:

• **INSPECCIONE Y QUITTE** cualquier residuo oculto de gran tamaño.

• **PASE LA CORTADORA** a una altura intermedia

• **INSPECCIONE** y quite el residuo restante

• **PASE LA CORTADORA** a la altura final

• **PROTECCIÓN CONTRA OBJETOS ARROJADOS DE LA CORTADORA:**

• **MANTENGA** todos los protectores contra objetos arrojados en su lugar y en buen funcionamiento al operar la cortadora, entre los que se incluyen los deflectores frontales y traseros, los protectores de cadena, las bandas, los faldones laterales y las zapatas antideslizantes.

• **NO OPERE LA CORTADORA** si falta algún protector contra objetos arrojados, o si éstos están dañados.

• Ninguna protección ofrece una eficacia del 100% en la prevención de objetos arrojados. Para reducir la posibilidad de que se produzcan lesiones:

• Detenga el corte si algún transeúnte se acerca a 100 metros (300 pies) a la redonda de la cortadora.

1. **MANTENGA LOS PROTECTORES DE LA CORTADORA**, los faldones laterales, las zapatas antideslizantes y las cuchillas en buen estado de funcionamiento.



2. **ELEVE LA ALTURA DE CORTE a 15 CM (6 PULGADAS)** como mínimo,

3. **INSPECCIONE EL ÁREA** con cuidado antes de pasar la cortadora para **ELIMINAR** el posible riesgo de **OBJETOS ARROJADOS,**

4. **NUNCA PERMITA QUE LAS CUCHILLAS EN MOVIMIENTO ENTREN EN CONTACTO CON OBJETOS SÓLIDOS** como alambres, piedras, postes, cordones, guardarrailes o el suelo. *PN TOBM-01 Spstr*

SEGURIDAD

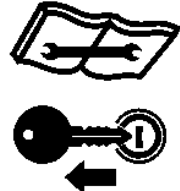
SEGURIDAD DE CONECTAR O DESCONECTAR IMPLEMENTO

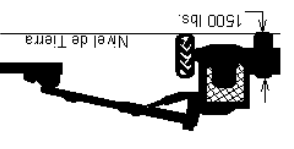
 <p>Detenga el tractor Quite la llave Lea el Manual</p>	 <p>Riesgo de aplastamiento. No se coloque debajo del brazo cuando conecte el cabezal de la cortadora al brazo</p>	 <p>Riesgo de estabilidad. Asegúrese de que el 20% del peso del tractor esté en las ruedas.</p>	 <p>Riesgo de estabilidad. Asegúrese de que haya una fuerza hacia abajo de 1500lb sobre la rueda izquierda con el brazo extendido.</p>
--	--	--	---

⚠ PELIGRO

PARA EVITAR LESIONES GRAVES O LA MUERTE POR APLASTAMIENTO POR EL TRACTOR O IMPLEMENTO:

- **CUANDO conecte el cabezal de la cortadora al brazo:**
- MANTENGALA LOS TRANSERENTES LEJOS del tractor y la cortadora.
- Asegúrese de que haya espacio suficiente para elevar y mover el brazo sin golpear objetos
- **ANTES de conectar y desconectar el cabezal de la cortadora o el brazo:**
- APAGUE EL MOTOR DEL TRACTOR, coloque la palanca en "estacionar", ponga el freno de mano y saque la llave.
- **CUANDO conecte y desconecte el cabezal de la cortadora o el brazo:**
- NO se agache o camine debajo del cabezal o el brazo de la cortadora en posición elevada. (Consulte las instrucciones en la sección de Operación)

AL CONECTAR LA LINEA DE CONDUCCIÓN DEL IMPLEMENTO: (Si está equipado)

PARA EVITAR que la línea de conducción del implemento se suelte durante la operación:

- LUBRIQUE el anillo de cierre del resorte del yugo para asegurarse de que se deslice libremente sobre el eje de TDF
- ASEGURE las bolas de cierre del yugo en la muesca del eje de TDF.
- PRESIONE y JALE LA LINEA DE CONDUCCIÓN del EJE DE TOMA DE FUERZA del tractor y del implemento para asegurarse de que estén FIRMEMENTE SUJETADOS

PARA EVITAR que la línea de conducción se rompa durante las operaciones:

- VERIFIQUE que la línea de conducción tenga el largo adecuado entre el eje de PTO y el eje de la caja de cambios del implement (Consulte las instrucciones en la sección de Operación)
- Las líneas de conducción demasado cortas se pueden soltar o romper.
- Las líneas de conducción demasado largas pueden tocar el suelo.
- Un ensamblaje telescópico de la línea de conducción que toque el suelo no se deslizará y se solidificará.
- Si la línea de conducción toca el suelo, puede atravesar los cojinetes de soporte y romper el eje de TDF(PTO).

COMUNIQUESE CON EL DISTRIBUIDOR si la línea de conducción del implemento no coincide con el eje de TDF(PTO) del tractor:

- NO UTILICE UN ADAPTADOR DE TDF(PTO).
- El uso de un adaptador de TDF(PTO) puede ocasionar:
- Vibración excesiva, caída de objetos, fallas de la cuchilla y el implemento como consecuencia de la duplicación de la velocidad operativa.
- Mayor extensión de trabajo, lo que deja expuestas áreas desprotegidas de la línea de conducción e implica el riesgo de enredo con otros objetos. *PN CDBM-01 SP str*

SEGURIDAD

SEGURIDAD

RIESGO DE APLASTAMIENTO

	Lesión por aplastamiento por la caída del brazo o el cabezal de la cortadora
	Lesión por aplastamiento causada por la caída del brazo o el cabezal de la cortadora
	Riesgo de punto de compresión. Mantenga las manos y el cuerpo lejos de los puntos de compresión
	Siempre utilice cinturón de seguridad
	Use un tractor con cabina con las cortadoras con brazo

SEGURIDAD

▲ PELIGRO PARA EVITAR LESIONES GRAVES O LA MUERTE POR CAÍDA DEL TRACTOR O ATROPELLO DEL EQUIPO, VUELCO O APLASTAMIENTO POR LA CAÍDA DE DEL BRAZO O EL IMPLEMENTO:

• USE tractores equipados con SISTEMA ANTIVUELCO (ROPS) y CINTURONES DE SEGURIDAD para las operaciones de corte.

• **MANTENGA EL SISTEMA ROPS** trabado en posición vertical.

• **SIEMPRE ABRÓCHESE** el cinturón de seguridad al operar el tractor y los equipos.

• **SOLO OPERE** el tractor y el equipo sentado en el asiento del tractor.

AL ELEVAR EL BRAZO DE LA CORTADORA:

• Eleve o descienda **SOLO CUANDO ESTÉ SENTADO** en el asiento del tractor, y con el cinturón de seguridad ajustado.

• **MANTENGA A LOS TRANSEÚNTES FUERA** del área de operación **PARA EVITAR** accidentes por aplastamiento.

• **MANTENGA** suficiente espacio libre alrededor de los implementos **PARA EVITAR** el contacto con edificios o cables elevados.

• **ELEVADO** El equipo puede caerse por una falla mecánica o hidráulica o por un movimiento involuntario de la palanca de control.

PARA EVITAR LA CAÍDA DEL EQUIPO al trabajar cerca o debajo del brazo elevado, los componentes y el cabezal de la cortadora:

• **SUJETE CON FIRMEZA** o bloquee en posición vertical todos los equipos, aletas y componentes elevados.

• **BLOQUEE EN POSICIÓN VERTICAL** y sujete con firmeza el equipo antes de poner las manos, los pies o el cuerpo debajo de los equipos o componentes elevados.

• **MANTENGA A LOS TRANSEÚNTES LEJOS** del brazo elevado o el cabezal de la cortadora hasta que estén bloqueados de forma segura.

AL ESTACIONAR el implemento y el tractor:

• **DESCIENDA** el cabezal de la cortadora hasta el suelo o BLOQUEE las partes elevadas antes de alejarse del equipo.

• **NUNCA** deje un implemento sin atención en posición elevada.





PARA EVITAR LA CAÍDA O EL APLASTAMIENTO DE NIÑOS POR EL EQUIPO:

• **NUNCA DEJE** que los niños jueguen sobre el tractor o los implementos, ni en sus alrededores.

• **NO OPERE** el equipo sin **CABINA CERRADA o PROTECCIÓN SUPERIOR**. Las ramas y los residuos que caen pueden causar lesiones. *PN CHBM-01SP str*

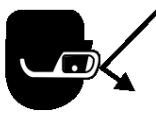
SEGURIDAD

SEGURIDAD DEL OPERADOR

	Lea con atención el Manual del Operador
	Siempre use gafas de seguridad
	Use casco y calzado protector
	Nunca consuma drogas o alcohol mientras opera el equipo
	Utilice chaleco de seguridad al operar en o cercas de carreteras

PARA EVITAR LESIONES GRAVES O LA MUERTE, SIGA LAS SIGUIENTES INSTRUCCIONES:



- LEA, COMPRENDA y SIGA las instrucciones del Manual del Operador, al igual que las Advertencias y Mensajes de Seguridad.
- USE GAFAS DE SEGURIDAD, calzado protector, casco, protección auditiva y guantes al operar o reparar el equipo. USE un aparato de respiración apropiado al operar en condiciones polvorientas a fin de evitar contraer enfermedades respiratorias.
- NO USE prendas sueltas o joyas que se puedan enredar con las partes giratorias y causar una lesión.
- NO CONSUMA DROGAS o ALCOHOL antes o durante la operación del equipo.
- NO PERMITA que nadie opere el equipo bajo los efectos negativos de las drogas o el alcohol.
- CONSULTE a un médico para conocer los efectos desfavorables de la medicación sobre los sentidos.
- EVITE EL CONTACTO con superficies calientes tales como silenciadores, bombas hidráulicas, válvulas y tanques.
- MANTÉNGASE ALERTA, la operación prolongada puede causar fatiga. HAGÁ UNA PAUSA y DESCANSE.
- SEGURIDAD DE OPERACIÓN GENERAL
- CONDICIONES DE VISIBILIDAD AL USAR LA CORTADORA:
 - OPERE LA CORTADORA CON LUZ SOLAR o con luz que aporte una visibilidad nítida de más de 90 metros (100 yardas).
 - DEBE PODER VISUALIZAR e identificar transvénites, terrenos empinados, pozos, desniveles, obstrucciones elevadas, cables de alimentación, residuos y objetos extraños.
 - Evite retroceder mientras opera la cortadora: la visión es limitada y pueden ocurrir daños o lesiones severas.
 - NO OPERE el tractor en un recinto cerrado sin ventilación adecuada de los gases de escape.
- VELOCIDAD RESPECTO AL SUELO AL USAR LA CORTADORA:
 - El rango de VELOCIDAD NORMAL es de entre 1 y 2 millas por hora (1-3kph).
 - AJUSTE LA VELOCIDAD DE CORTE según las condiciones del terreno y el tipo de césped, la densidad y la altura del corte.
 - REDUZCA LA VELOCIDAD DE CORTE al acercarse a inclinaciones empinadas, pozos, desniveles, obstrucciones elevadas, cables de alimentación y para evitar residuos y objetos extraños.
- TRACTOR y CORTADORA
 - NO OPERE el tractor o la cortadora a menos que hayan recibido el mantenimiento adecuado y funcionen correctamente.
 - DETENGA LA OPERACIÓN si los controles eléctricos o hidráulicos del tractor o la cortadora no funcionan correctamente.
 - DETENGA LA OPERACIÓN del tractor si los sistemas de frenado o dirección no funcionan correctamente.
 - NO OPERE el tractor o la cortadora si hay pérdidas de líquido hidráulico.
- INFESTACIÓN CON INSECTOS
 - No opere en áreas susceptibles al ataque de abejas o insectos, salvo que USE PRENDAS PROTECTORAS o una cabina de tractor cerrada.
- VELOCIDAD DE CUCHILLAS DE LA CORTADORA:
 - NO EXCEDA LA VELOCIDAD NOMINALES DE RPM DEL IMPLEMENTO.
 - EVITE superar las velocidades nominales de RPM de la cabeza cortadora, porque puede resultar sobrecalentamiento o fallas en el componente y las cuchillas.
- SEÑALES DE SEGURIDAD:
 - REEMPLACE cualquier señal de seguridad faltante, dañada o ilegible PN OSBM-01 SPstr

RMB 1445 08/22

Sección de Seguridad 1-3

SEGURIDAD

SEGURIDAD

INSTRUCCIONES DE SEGURIDAD Y PRÁCTICAS GENERALES

El mejor operador es un operador cuidadoso. La seguridad es de importancia fundamental para el fabricante, y también debería serlo para el propietario u operador. La mayoría de los accidentes se pueden evitar prestando suma atención al equipo, al ambiente circundante, y tomando algunas precauciones. La primera sección de este manual incluye una lista de Mensajes de Seguridad que deben observarse para contribuir a la protección del operador y otras personas frente a lesiones o la muerte. Lea con atención estos Mensajes de Seguridad antes de ensamblar, operar o reparar este implemento. Este equipo sólo debe ser operado por personas que hayan leído el manual, responsables y calificadas, que sepan cómo hacerlo de manera responsable.

El Símbolo de Alerta de Seguridad se utiliza en combinación con una Señal Verbal, tal como la que se muestra a continuación, en todo este manual y en los autoadhesivos adheridos a los equipos. El Símbolo de Alerta de Seguridad significa:



“¡ATENCIÓN! MANTÉNGASE ALERTA! SU SEGURIDAD ESTÁ EN JUEGO!” El Símbolo y la Señal Verbal tienen el objetivo de advertir al propietario/operador sobre un riesgo inminente y el grado de lesión que se puede producir al operar este equipo.

Adopte todas las medidas habituales para trabajar en forma segura y, sobre todo, recuerde que la seguridad depende de USTED. Sólo USTED puede impedir una lesión grave o la muerte a causa de prácticas no seguras.

▲ PELIGRO Indica una situación peligrosa inminente que, de no ser evitada, OCASIONARÁ la MUERTE O UNA LESIÓN MUY GRAVE.

▲ ADVERTENCIA Indica una situación peligrosa inminente que, de no ser evitada, PODRÍA OCASIONAR la MUERTE O UNA LESIÓN MUY GRAVE.

▲ PRECAUCIÓN Indica una situación peligrosa inminente que, de no ser evitada, PODRÍA OCASIONAR UNA LESIÓN MENOR.

Importante Identifica instrucciones o procedimientos específicos que, de no observarse estrictamente, podrían ocasionar daños o la destrucción de la maquinaria, los accesorios o el entorno.

NOTA: Identifica aspectos de particular interés para lograr una operación o reparación más eficiente y conveniente.

LEA CON ATENCIÓN Y RESPETE los siguientes Mensajes de Seguridad. Si no se siguen cuidadosamente las advertencias e instrucciones indicadas en este Manual y en los Mensajes de Seguridad del implemento, se pueden producir lesiones graves o la muerte. Siempre siga las instrucciones de este manual y use el sentido común para evitar situaciones peligrosas. Los pictogramas se utilizan a lo largo de este manual para ayudar a que su atención visual se centre en los problemas de seguridad.



PELIGRO DE SEGURIDAD	PROCEDIMIENTO DE EVITACIÓN	PREVENCIÓN DE SEGURIDAD
<p>El pictograma rodeado por un triángulo indica un peligro de seguridad que debe evitarse.</p> <p>EJEMPLO:</p> <p>Equipo en contacto con líneas eléctricas</p>	<p>El pictograma por sí mismo o dentro de una caja indica un procedimiento de evitación que se debe seguir para evitar lesiones.</p> <p>EJEMPLO:</p> <p>Apaque siempre el motor y retire la llave antes de trabajar en el equipo.</p>	<p>Un círculo con una barra indica una acción que está prohibida.</p> <p>EJEMPLO:</p> <p>No FUMAR</p>

NOTA: Si desea obtener una traducción de esta sección de seguridad en alguno de los siguientes idiomas, comuníquese con: Translations, a la dirección 1502 E. Walnut Street Seguin, TX 78155; Fax: (830) 372-9529; La Sección de Seguridad está disponible en español, portugués, francés, alemán, ruso. PN 6501 SPstr

SECCIÓN DE SEGURIDAD

Sección de Seguridad 1-1

Instrucciones de operaciones antes de la entrega del DISTRIBUIDOR al CLIENTE

El distribuidor deberá informar al comprador de este producto las condiciones, disposiciones y procedimientos de garantía aplicables; informar la responsabilidad del comprador de capacitar a sus operadores para la operación segura; revisar el contenido del Manual del Operador, incluido el equipo de seguridad, la operación segura y el mantenimiento; y revisar las Señales de Seguridad que se encuentran en el implemento (y en el tractor, de ser posible).

- **IMPLEMENTOS:** He explicado que los deflectores, protectores de cadena o faldones sólidos se deben mantener en buenas condiciones de reparación y se deben instalar, excepto en zonas donde personas, vehículos, ganado u otros bienes no corran peligro por objetos arrojados, y en los casos en que dichos equipos de seguridad impedirían un desempeño razonable de la cortadora en su tarea asignada.
- **LÍNEAS DE CONDUCCIÓN:** Me he asegurado de que todos los protectores de líneas de conducción, de caja de engranajes y otros están en buenas condiciones de reparación y firmemente sujetados para prevenir lesiones por enredo u objetos arrojados.
- **MÁQUINAS HIDRÁULICAS:** He explicado la necesidad de usar aceite hidráulico limpio, cambiar los filtros según las instrucciones, detener filtraciones, prevenir daños por operar con aceite demasado caliente, cuidar las mangueras, usar mangueras del tipo correcto, mantener la presión operativa especificada y prevenir el posible riesgo de que el aceite penetre en la piel.
- **IMPLEMENTOS PLEGABLES:** He explicado que no es posible proteger contra objetos arrojados cuando el cabezal está elevado del suelo y que el operador es responsable de verificar que no existan personas en las inmediaciones. He explicado que el brazo o cabezal de cortadora elevada puede entrar en contacto con obstrucciones elevadas y dañar cables y líneas telefónicas, y posiblemente causar lesiones. He explicado que el brazo o cabezal extendido, o el brazo retraído, puede entrar en contacto con cables de alimentación y causar lesiones o la muerte por electrocución, y que el operador es responsable de evitar dichos riesgos.

SERVICIO ANTES DE LA ENTREGA

VERIFIQUE Y AJUSTE O LUBRIQUE SEGUN SEA NECESARIO

Consulte los detalles en el Manual del Operador

Inspección realizada – Garantía y procedimientos de seguridad explicados – Instalación realizada

LUBRICACIÓN E HIDRÁULICA

CONEXIONES DE CORTADORA A TRACTOR

- Caja de engranajes (niveles de aceite)
- Nivel de aceite hidráulico (tanque externo)
- Nivel de aceite hidráulico del tractor
- Mangueras hidráulicas (no retorcidas y ajustadas)
- Propulsor de bomba frontal (conjunto ajustado y eje bien alineado)

CORTADORA

- Pernos de husillo y motor bien ajustados
- Nivel de aceite del husillo
- Pernos de porta cuchillas bien ajustados/pasadores de retención colocados
- Nivel y altura de corte de la cortadora ajustados
- Cuchillas del eje de corte lubricados
- Todas las piezas metálicas bien ajustadas
- Presión de aire y neumáticos/tuercas de rueda (bien ajustadas)
- Cojinetes de rueda (verificar, engrasar y hacer carga previa)

ACCESORIOS E INSTALACIÓN

- Deflectores frontales y traseros
 - Accesorios de trituración
 - Sentido de giro de las hojas correcto
 - Vigas y brazos de eje
 - Lengüeta y barras de control (instaladas y ajustadas)
 - Todos los pernos, pasadores y tuercas (ajuste correcto)
- ### ELEMENTOS DE SEGURIDAD
- Embrague de línea de conducción (limitador de ajuste) (ajustar y poner en marcha)
 - Autoadhesivos de seguridad (colocados)
 - Manual del Operador (entregado)
 - Protector de TDF del tractor (instalado)
 - Emblema S.M.V. (instalado de ser necesario)
 - Gato con lengüeta (instalación y operación)
 - Cadena de remolque de seguridad (instalada)
 - Manual de Seguridad de Línea de Conducción ADMA (entregado)
 - Se mostró el Video de Seguridad de Cortadora AEM al comprador

Bush Hog está dispuesto a suministrar un (1) Video de Prácticas de Seguridad para Cortadoras AEM

Por favor enviar:

- Video de Seguridad para el Operador de Cortadoras AEM/FEMA – formato VHS
- Video de Seguridad para el Operador de Cortadoras AEM/FEMA – formato DVD
- Manual del Operador de la Cortador
- Manual de Seguridad del Operador de la Cortadora AEM

Nombre del solicitante: _____ Teléfono: _____

Dirección del solicitante: _____

Ciudad: _____

Estado: _____

Código postal: _____

Modelo de cortadora: _____ Número de serie: _____

Fecha de compra: _____ Vendedor del distribuidor: _____

Nombre del distribuidor: _____ Dirección del distribuidor: _____

Enviar por correo a:

AEM Video Services
1502 E. Walnut Street
Seguin, TX 78155

O enviar por fax a:

(830) 372-9529

O enviar por correo electrónico a:

AEMVideo@alamo-group.com

A fin de reducir la tasa de accidentes y mejorar la operación segura de las cortadoras, Bush Hog se ha asociado con otros fabricantes de la industria para desarrollar el video y la guía de Prácticas de Seguridad para Cortadoras Industriales y Agrícolas AEM/FEMA.

El video explica a los operadores de tractores y cortadoras las prácticas seguras que deben adoptar cuando utilizan cortadoras industriales y agrícolas. Es importante que todos los operadores de cortadoras aprendan cómo operar sus equipos de corte y puedan reconocer los posibles peligros que pueden surgir al operar una cortadora. Este video, en conjunto con el manual del operador de la cortadora y los mensajes de advertencia que se encuentran en la cortadora, serán muy útiles para complementar este aprendizaje tan importante.

Es posible que su distribuidor autorizado de *Bush Hog* le haya mostrado este video y le haya entregado una copia en DVD cuando adquirió su cortadora. Si usted o algún operador de cortadora no vio el video, mire el video, lea este Manual del Operador, y complete la Guía del Video antes de operar su cortadora nueva. Si no comprende alguna de las instrucciones del video o del manual del operador, o si tiene alguna pregunta acerca de la operación segura, comuníquese con su supervisor, con el distribuidor o con Industrial.

Si desea recibir una copia del video en VHS, envíe un mensaje de correo electrónico a AEMVideo@alamo-group.com o un fax al (830) 372-9529, o envíe por correo una copia rellena del formulario que se encuentra al dorso de esta página a AEM VHS Video 1502 E Walnut Street, Seguin, TX 78155, y solicite la versión en VHS. Indique su nombre, dirección postal, modelo de cortadora y número de serie.

Cada uno de los operadores debe recibir capacitación para cada equipo (tractor y cortadora), comprender el uso previsto, y comprender los posibles peligros antes de operar el equipo.

La información y material mencionado en la información anterior junto con el Manual de Operador puede asistir en cumplir con los requisitos de OSHA para el entrenamiento anual del Operador.

REQUISITOS DE ENTRENAMIENTO DEL OSHA

Los siguientes requisitos de entrenamiento se an toma de Título 29, código de la pieza de regulaciones federales 1928.57 (a) (6), www.osha.gov

Instrucciones del operador. A la hora de la asignación inicial y por lo menos anualmente después de eso, el empleador mandará a cada empleado quien opera un tractor agrícola o implemento en las prácticas de operación segura y el mantenimiento de el equipo con el cual el empleado este, o estará implicado y de cualquier otras prácticas dictados por el ambiente laboral.

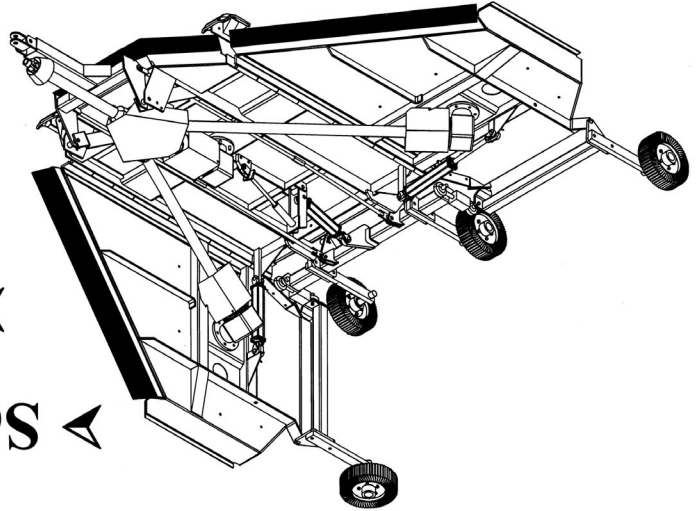

➤ **Sea Seguro**

➤ **Sea Alerto**

➤ **Sea Vivo**

➤ **Sea Entrenado**

antes de funcionar
el cortacésped

Entrenamiento de Seguridad
Hace la Diferencia

Bush Hog Image_SP

www.algqr.com/bvs



Video de Seguridad

AL PROPIETARIO/OPERADOR/DISTRIBUIDOR

Este Manual del Operador es una parte esencial de la operación segura de esta máquina y se debe mantener con la unidad siempre. El implemento incluye un porta manual donde se puede guardar el manual de manera adecuada. Si el manual se extravía o se daña, puede solicitar otra copia sin cargo a un distribuidor autorizado de *Bush Hog* o descargarlo del sitio web de *Bush Hog* (www.bushhog.com).

ANTES DE COMENZAR LEA, COMPRENDA Y SIGA la información incluida en este manual, el Manual de Seguridad de la Cortadora AEM y el manual del operador del tractor para conocer cómo operar la máquina y realizar tareas de servicio correctamente. De lo contrario, podría sufrir lesiones u ocasionar lesiones a terceros. Todos los implementos con partes móviles son potencialmente peligrosos. Cada esfuerzo ha sido hecho para asegurar que la máquina esté segura, pero los operadores deben evitar entrar en prácticas peligrosas y seguir las instrucciones escritas que son proporcionadas. El fabricante ha diseñado este implemento para ser usado con todos sus equipos de seguridad correctamente sujetados para minimizar la probabilidad de accidentes.

LA SEGURIDAD PRIMERO. Lea con atención la totalidad de la sección de seguridad de este manual antes de operar el equipo. No permita que nadie opere el equipo sin haber leído y comprendido la totalidad de este manual. Comuníquese con el distribuidor si necesita explicación sobre alguna instrucción que no haya comprendido del todo.

Los cuidados que brinde a su implemento *Bush Hog* determinarán en gran medida su satisfacción con el desempeño y la vida útil del equipo. Lea con atención y siga las instrucciones de este manual para comprender cabalmente su nuevo implemento, su uso previsto, y sus requisitos de servicio.

Todas las referencias que se hacen en este manual a derecha, izquierda, frontal, trasero, arriba y abajo corresponden a la perspectiva en el sentido del desplazamiento hacia delante con el implemento correctamente sujetado al tractor.

La información sobre repuestos se encuentra por separado en el Manual de Partes. Las cortadoras *Bush Hog* utilizan componentes del sistema equilibrados y coincidentes para porta cuchillas, cuchillas, ejes de corte, hojas, ganchos para hojas, rodillos, componentes de los engranajes, y cojinetes. Estas partes se fabrican y se prueban según las especificaciones de *Bush Hog*. Las partes compatibles no genuinas no siempre cumplen con estas especificaciones. El uso de partes no genuinas puede perjudicar el desempeño de la cortadora, anular la garantía y presentar un riesgo para la seguridad. Use partes genuinas *Bush Hog* para ahorrar dinero y maximizar la seguridad.

Para referencia futura, registre el número de modelo y el número de serie de *Bush Hog* que ha adquirido

Distribuidor	Teléfono	Fecha de compra:	Número de serie	Dueño
			Fecha de modelo:	

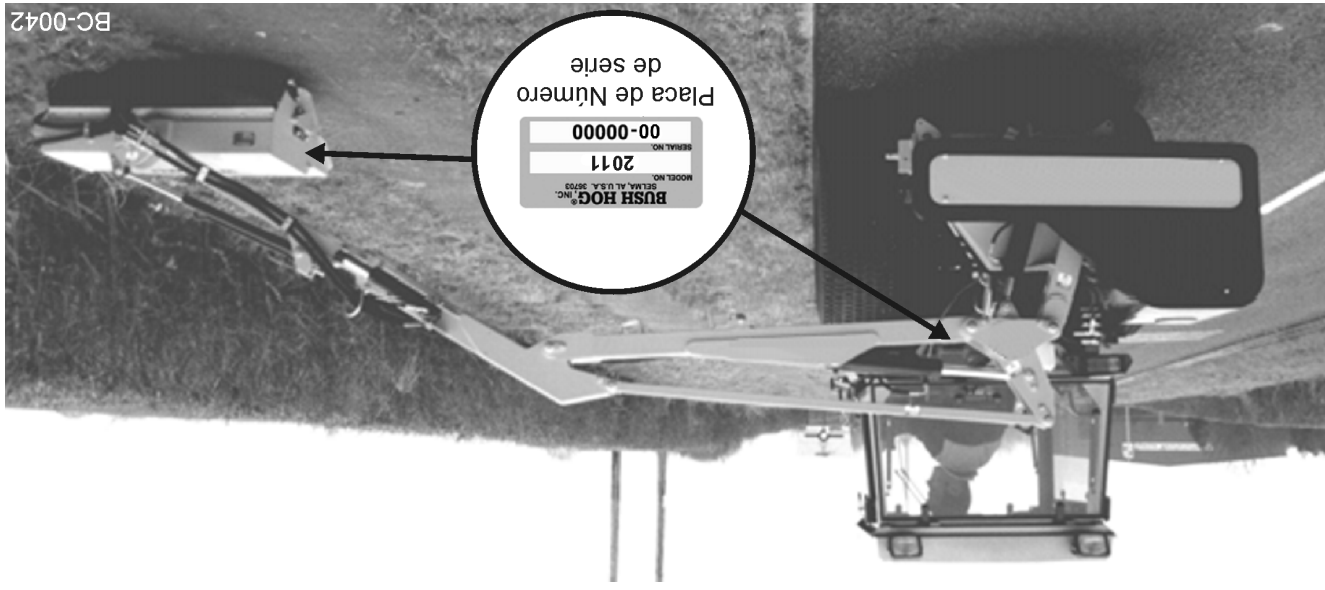

RMB 1445

CORTADORA CON BRAZO HYDRAULICO

BUSH HOG®



Publicado en 08/22

Parte n° 50068815

MANUAL DE OPERADOR

Este Manual del Operador es una parte esencial de la operación segura de esta máquina y se debe mantener con la unidad siempre. **LEA, ENTIENDA, y SIGA** las Instrucciones de Seguridad y Operación contenidas en este manual antes de operar el equipo. *C01-Cover SP_B str*

Importantes instrucciones de operación y las instrucciones de seguridad se encuentran en el video Cortacésped Sobre Seguridad que se puede acceder instantáneamente en el Internet en: www.algqr.com/bvs



www.algqr.com/bvs



BUSH HOG®

2501 Griffin Ave.

Selma, AL 36703

334-874-2700

www.bushhog.com

Página Web de Bush Hog

www.algqr.com/bwe



ATTENTION!



If you do not read
Read Manual
spanish
please flip manual over in
english.



© 2022 Alamo Group Inc.